



12V Mega TLynx™ : Non-Isolated DC-DC Power Modules:  
6.0Vdc – 14Vdc input; 0.8 to 3.63Vdc Output; 30A Output Current

TUNABLE  
LOOP™  
A LINEAGE POWER TRADEMARK



RoHS Compliant

### Applications

- Distributed power architectures
- Intermediate bus voltage applications
- Telecommunications equipment
- Servers and storage applications
- Networking equipment

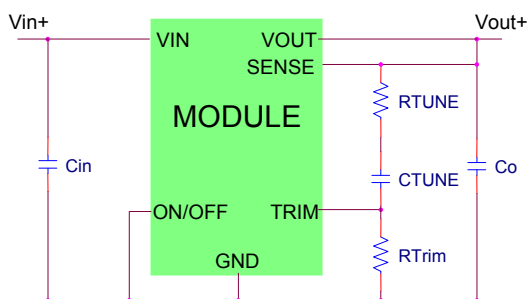

### Description

The 12V Mega TLynx™ power modules are non-isolated dc-dc converters™ that can deliver up to 30A of output current. These modules operate over a wide range of input voltage ( $V_{IN} = 6Vdc-14Vdc$ ) and provide a precisely regulated output voltage from 0.8Vdc to 3.63Vdc, programmable via an external resistor. Features include remote On/Off, adjustable output voltage, over current and over temperature protection, output voltage sequencing and paralleling with active current sharing (-P versions). A new feature, the Tunable Loop™, allows the user to optimize the dynamic response of the converter to match the load with reduced amount of output capacitance leading to savings on cost and PWB area

### Features

- Compliant to RoHS EU Directive 2002/95/EC (-Z versions)
- Compliant to ROHS EU Directive 2002/95/EC with lead solder exemption (non-Z versions)
- Compliant to IPC-9592 (September 2008), Category 2, Class II
- Delivers up to 30A of output current
- High efficiency: 92.9% @ 3.3V full load ( $V_{IN}=12Vdc$ )
- Input voltage range from 6 to 14Vdc
- Output voltage programmable from 0.8 to 3.63Vdc
- Small size and low profile:
  - 33.0 mm x 13.46 mm x 10.00 mm  
(1.30 in. x 0.53 in. x 0.39 in.)
- Monotonic start-up
- Startup into pre-biased output
- Output voltage sequencing (EZ-SEQUENCE™)
- Remote On/Off
- Remote Sense
- Over current and Over temperature protection
- Option- Parallel operation with active current sharing
- Wide operating temperature range (-40°C to 85°C)
- UL\* 60950 Recognized, CSA† C22.2 No. 60950-00 Certified, and VDE‡ 0805 (EN60950-1 3<sup>rd</sup> edition) Licensed
- ISO\*\* 9001 and ISO 14001 certified manufacturing facilities

\* UL is a registered trademark of Underwriters Laboratories, Inc.

† CSA is a registered trademark of Canadian Standards Association.

‡ VDE is a trademark of Verband Deutscher Elektrotechniker e.V.

\*\* ISO is a registered trademark of the International Organization of Standards

## Absolute Maximum Ratings

Stresses in excess of the absolute maximum ratings can cause permanent damage to the device. These are absolute stress ratings only, functional operation of the device is not implied at these or any other conditions in excess of those given in the operations sections of the data sheet. Exposure to absolute maximum ratings for extended periods can adversely affect the device reliability.

Parameter	Device	Symbol	Min	Max	Unit
Input Voltage Continuous	All	$V_{IN}$	-0.3	15	Vdc
Sequencing pin voltage	All	$V_{SEQ}$	-0.3	15	Vdc
Operating Ambient Temperature (see Thermal Considerations section)	All	$T_A$	-40	85	°C
Storage Temperature	All	$T_{stg}$	-55	125	°C

## Electrical Specifications

Unless otherwise indicated, specifications apply over all operating input voltage, resistive load, and temperature conditions.

Parameter	Device	Symbol	Min	Typ	Max	Unit
Operating Input Voltage	All	$V_{IN}$	6.0	12	14	Vdc
Maximum Input Current ( $V_{IN} = V_{IN,min}$ , $V_O = V_{O,set}$ , $I_O = I_{O,max}$ )	All	$I_{IN,max}$			19	Adc
Inrush Transient	All	$I^2 t$			1	$A^2 s$
Input No Load Current ( $V_{IN} = 12.0Vdc$ , $I_O = 0$ , module enabled)	$V_{O,set} = 0.8 Vdc$	$I_{IN,No load}$		91		mA
	$V_{O,set} = 3.3Vdc$	$I_{IN,No load}$		265		mA
Input Stand-by Current ( $V_{IN} = 12.0Vdc$ , module disabled)	All	$I_{IN,stand-by}$		20		mA
Input Reflected Ripple Current, peak-to-peak (5Hz to 20MHz, 1 $\mu$ H source impedance; $V_{IN} = 6.0V$ to 14.0V, $I_O = I_{O,max}$ ; See Figure 1)	All			100		mAp-p
Input Ripple Rejection (120Hz)	All			50		dB

### Electrical Specifications (continued)

Parameter	Device	Symbol	Min	Typ	Max	Unit
Output Voltage Set-point ( $V_{IN}=V_{IN,nom}$ , $I_O=I_{O,nom}$ , $T_{ref}=25^{\circ}C$ )	All	$V_{O, set}$	-1.5	—	+1.5	% $V_{O, set}$
Output Voltage (Over all operating input voltage, resistive load, and temperature conditions until end of life)	All	$V_{O, set}$	-3.0	—	+3.0	% $V_{O, set}$
Adjustment Range Selected by an external resistor	All		0.8		3.63	Vdc
Output Regulation Line ( $V_{IN}=V_{IN, min}$ to $V_{IN, max}$ ) Load ( $I_O=I_{O, min}$ to $I_{O, max}$ ) Temperature ( $T_{ref}=T_{A, min}$ to $T_{A, max}$ )	All All All		— — —	— — 0.5	10 10 1	mV mV % $V_{O, set}$
Output Ripple and Noise on nominal output ( $V_{IN}=V_{IN, nom}$ and $I_O=I_{O, min}$ to $I_{O, max}$ $C_{OUT} = 0.1\mu F // 47 \mu F$ ceramic capacitors) Peak-to-Peak (5Hz to 20MHz bandwidth)	All		—		50	mV <sub>pk-pk</sub>
External Capacitance <sup>1</sup> Without the Tunable Loop™ ESR $\geq 1$ m $\Omega$	All	$C_{O, max}$	0	—	200	$\mu F$
With the Tunable Loop™ ESR $\geq 0.15$ m $\Omega$ ESR $\geq 10$ m $\Omega$	All All	$C_{O, max}$ $C_{O, max}$	0 0	— —	1000 10000	$\mu F$ $\mu F$
Output Current ( $V_{IN} = 6$ to 14Vdc)	All	$I_o$	0		30	Adc
Output Current Limit Inception (Hiccup Mode)	All	$I_{O, lim}$		140		% $I_{Omax}$
Output Short-Circuit Current ( $V_O \leq 250mV$ ) ( Hiccup Mode )	All	$I_{O, s/c}$	—	3.5	—	Adc
Efficiency $V_{IN}=12Vdc$ , $T_A=25^{\circ}C$ $I_O=I_{O, max}$ , $V_O=V_{O, set}$	$V_{O, set} = 0.8dc$ $V_{O, set} = 1.2Vdc$ $V_{O, set} = 1.8Vdc$ $V_{O, set} = 2.5Vdc$ $V_{O, set} = 3.3Vdc$	$\eta$ $\eta$ $\eta$ $\eta$ $\eta$		83.0 87.1 90.1 91.8 92.9		% % % % %
Switching Frequency, Fixed	All	$f_{sw}$	—	300	—	kHz

### General Specifications

Parameter	Min	Typ	Max	Unit
Calculated MTBF ( $V_{IN}=12V$ , $V_O=2.5Vdc$ , $I_O=0.8I_{O, max}$ , $T_A=40^{\circ}C$ , 200LFM) Per Telcordia Issue 2 Method 1 Case 3		4,443,300		Hours
Weight	—	7.04 (0.248)	—	g (oz.)

## Feature Specifications

Unless otherwise indicated, specifications apply over all operating input voltage, resistive load, and temperature conditions. See Feature Descriptions for additional information.

Parameter	Device	Symbol	Min	Typ	Max	Unit
On/Off Signal Interface ( $V_{IN}=V_{IN, min}$ to $V_{IN, max}$ ; open collector or equivalent, Signal referenced to GND) Logic High (On/Off pin open – Module OFF) Input High Current Input High Voltage Logic Low (Module ON) Input Low Current Input Low Voltage	All All All All	$I_{IH}$ $V_{IH}$ $I_{IL}$ $V_{IL}$	25 3.0 — -0.3	— — — —	200 $V_{IN, max}$ 200 1.2	$\mu A$ V $\mu A$ V
Turn-On Delay and Rise Times ( $V_{IN}=V_{IN, nom}$ , $I_O=I_{O, max}$ , $V_O$ to within $\pm 1\%$ of steady state) Case 1: On/Off input is enabled and then input power is applied (delay from instant at which $V_{IN} = V_{IN, min}$ until $V_O = 10\%$ of $V_{O, set}$ ) Case 2: Input power is applied for at least one second and then the On/Off input is enabled (delay from instant at which Von/Off is enabled until $V_O = 10\%$ of $V_{O, set}$ ) Output voltage Rise time (time for $V_O$ to rise from 10% of $V_{O, set}$ to 90% of $V_{O, set}$ )	All All All	$T_{delay}$ $T_{delay}$ $T_{rise}$	— — 2	2.5 2.5 —	5 5 10	msec msec msec
Output voltage overshoot $I_O = I_{O, max}$ ; $V_{IN, min} - V_{IN, max}$ , $T_A = 25^\circ C$					3.0	% $V_{O, set}$
Remote Sense Range	All		—	—	0.5	V
Over temperature Protection (See Thermal Consideration section)	All	$T_{ref}$	—	125	—	$^\circ C$
Sequencing Slew rate capability ( $V_{IN, min}$ to $V_{IN, max}$ ; $I_{O, min}$ to $I_{O, max}$ $V_{SEQ} < V_O$ )	All	$dV_{SEQ}/dt$		—	2	V/msec
Sequencing Delay time (Delay from $V_{IN, min}$ to application of voltage on SEQ pin)	All	$T_{SEQ-delay}$	10			msec
Tracking Accuracy Power-up (2V/ms) Power-down (1V/ms) ( $V_{IN, min}$ to $V_{IN, max}$ ; $I_{O, min}$ - $I_{O, max}$ $V_{SEQ} < V_O$ )	All	$V_{SEQ} - V_O$ $V_{SEQ} - V_O$		100 200	200 400	mV mV
Input Undervoltage Lockout Turn-on Threshold Turn-off Threshold	All All			5.5 5.0		Vdc Vdc
Forced Load Share Accuracy	-P		—	10		% $I_O$
Number of units in Parallel	-P				5	

### Characteristic Curves

The following figures provide typical characteristics for the APTS030A0X3-SRPHZ at 0.8V out and 25°C.

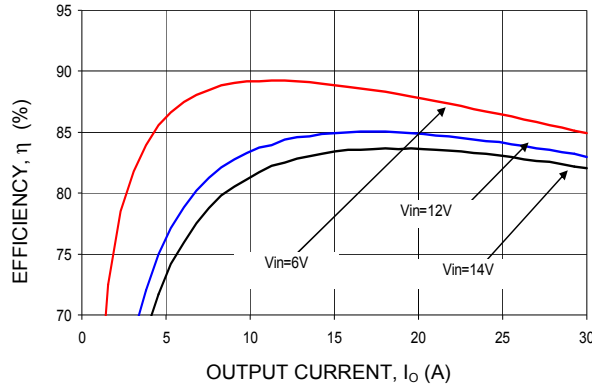

Figure 1. Converter Efficiency versus Output Current.

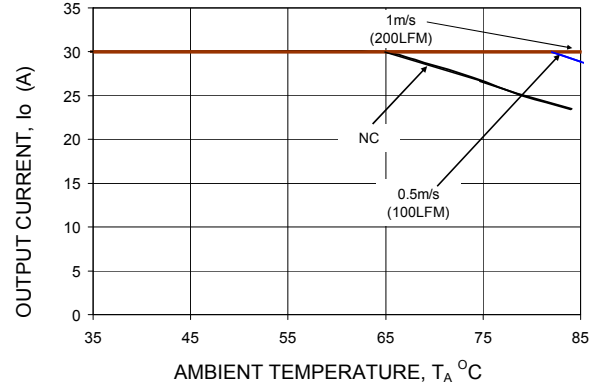

Figure 4. Derating Output Current versus Ambient Temperature and Airflow at 12V in.

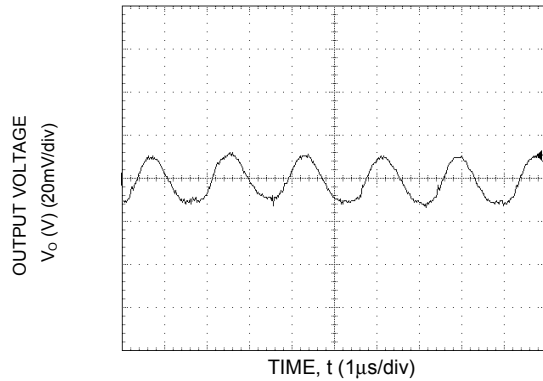

Figure 2. Typical output ripple and noise ( $V_{IN} = 12V$ ,  $I_o = 30A$ ,  $C_{OUT} = 0.1\mu F // 47\mu F$  ceramic capacitors).

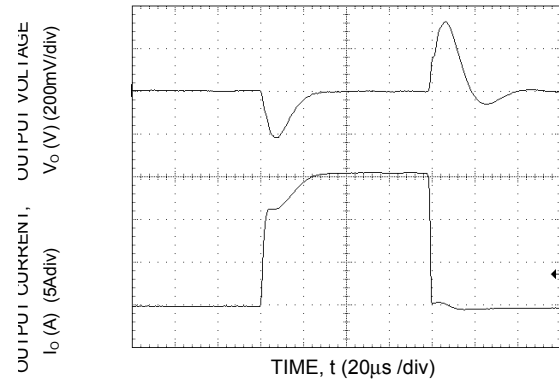

Figure 5. Transient Response to Dynamic Load Change from 0% to 50% to 0% with  $V_{IN}=12V$ .

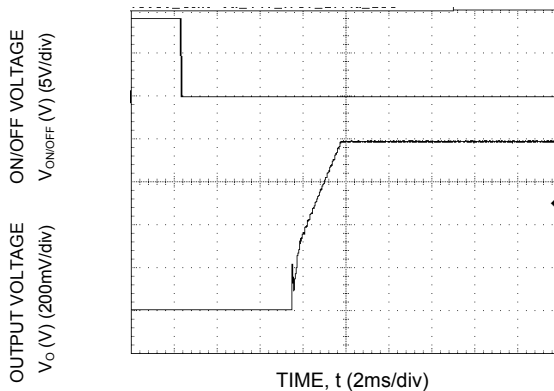

Figure 3. Typical Start-up Using On/Off Voltage ( $I_o = I_{o,max}$ ).

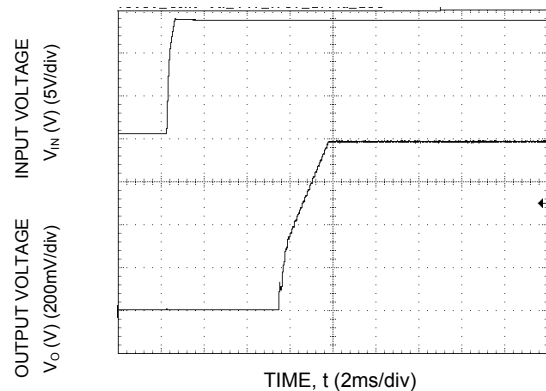

Figure 6. Typical Start-up Using Input Voltage ( $V_{IN} = 14V$ ,  $I_o = I_{o,max}$ ).

### Characteristic Curves

The following figures provide typical characteristics for the APTS030A0X3-SRPHZ at 1.2V out and 25°C.

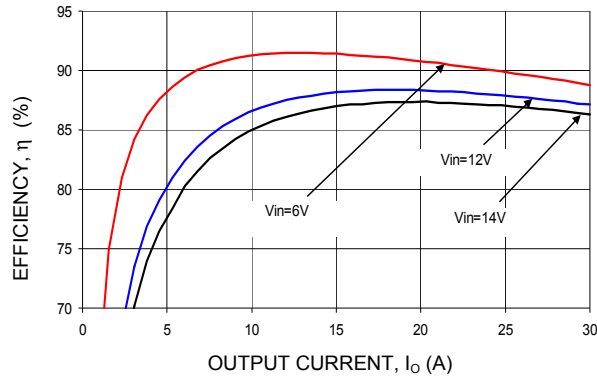

Figure 7. Converter Efficiency versus Output Current.

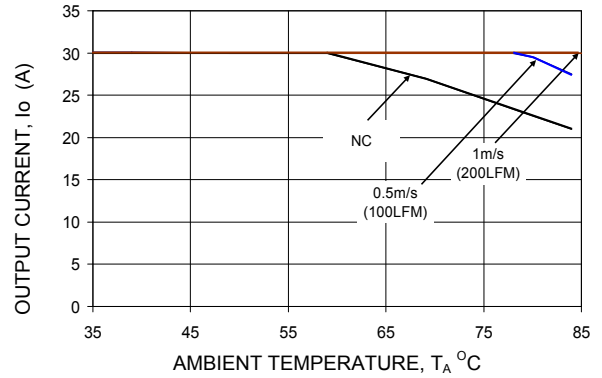

Figure 10. Output Current Derating versus Ambient Temperature and Airflow at 12V in.

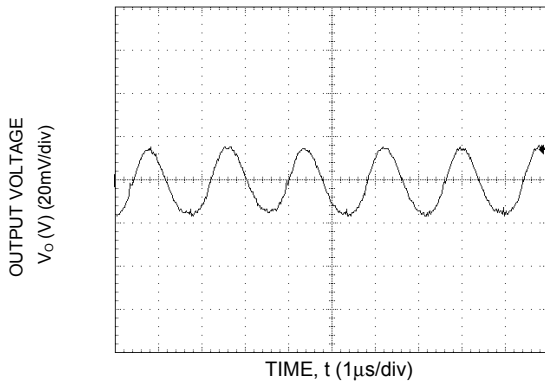

Figure 8. Typical output ripple and noise ( $V_{IN} = 12V$ ,  $I_o = 30A$ ,  $C_{OUT} = 0.1\mu F // 47\mu F$  ceramic capacitors).

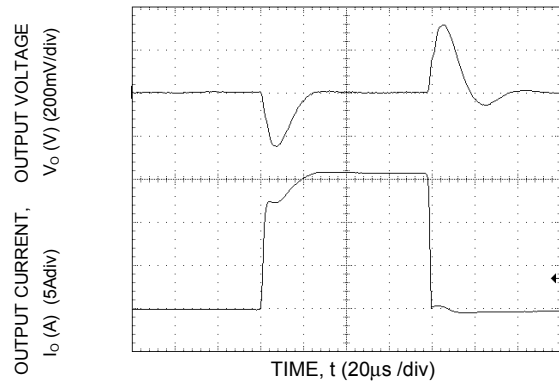

Figure 11. Transient Response to Dynamic Load Change from 0% to 50% to 0% with  $V_{IN}=12V$ .

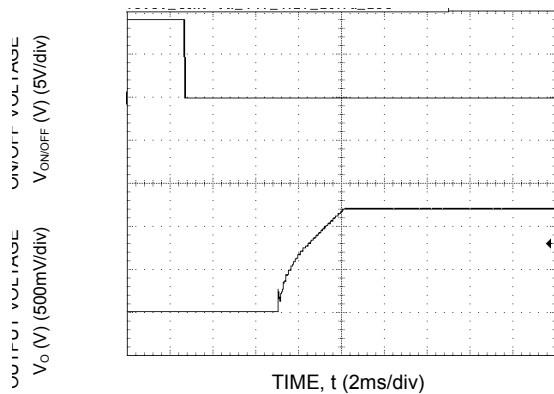

Figure 9. Typical Start-up Using On/Off Voltage ( $I_o = I_{o,max}$ ).

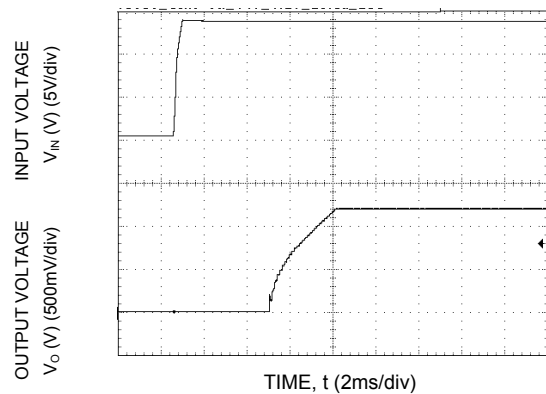

Figure 12. Typical Start-up Using Input Voltage ( $V_{IN} = 14V$ ,  $I_o = I_{o,max}$ ).

### Characteristic Curves

The following figures provide typical characteristics for the APTS030A0X3-SRPHZ at 1.8V out and 25°C.

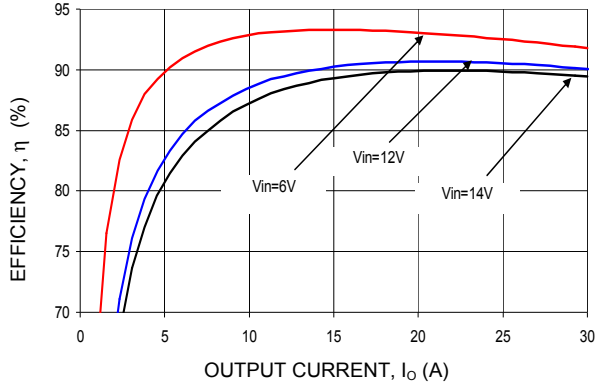

Figure 13. Converter Efficiency versus Output Current.

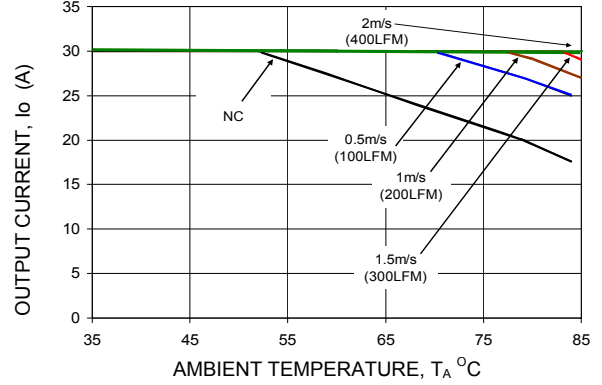

Figure 16. Output Current Derating versus Ambient Temperature and Airflow at 12V in.

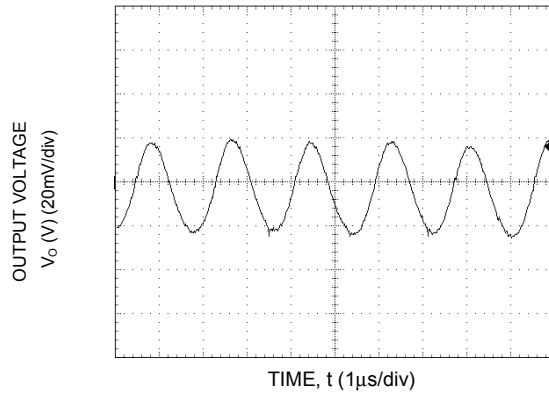

Figure 14. Typical output ripple and noise ( $V_{IN} = 12V$ ,  $I_o = 30A$ ,  $C_{OUT} = 0.1\mu F // 47\mu F$  ceramic capacitors).

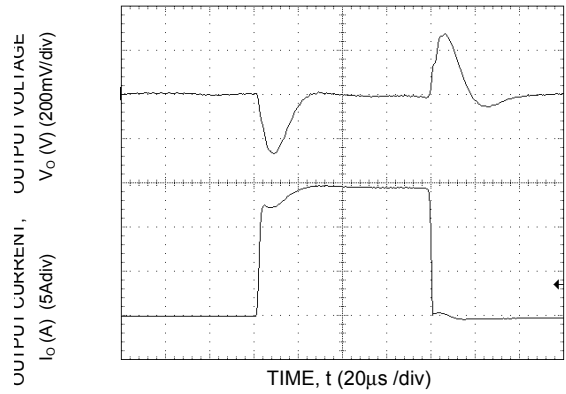

Figure 17. Transient Response to Dynamic Load Change from 0% to 50% to 0% with  $V_{IN}=12V$ .

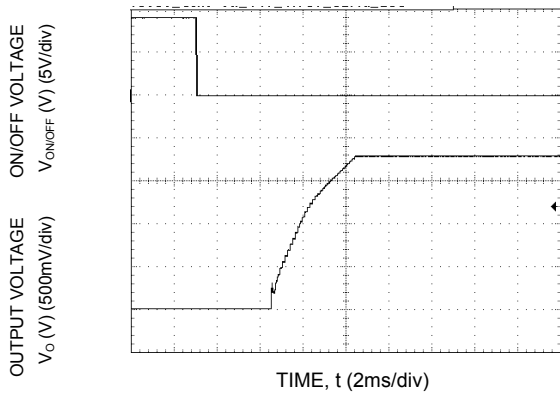

Figure 15. Typical Start-up Using On/Off Voltage ( $I_o = I_{o,max}$ ).

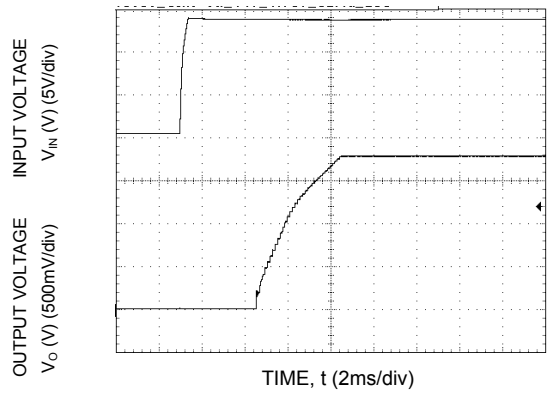

Figure 18. Typical Start-up Using Input Voltage ( $V_{IN} = 14V$ ,  $I_o = I_{o,max}$ ).

### Characteristic Curves

The following figures provide typical characteristics for the APTS030A0X3-SRPHZ at 2.5V out and 25°C.

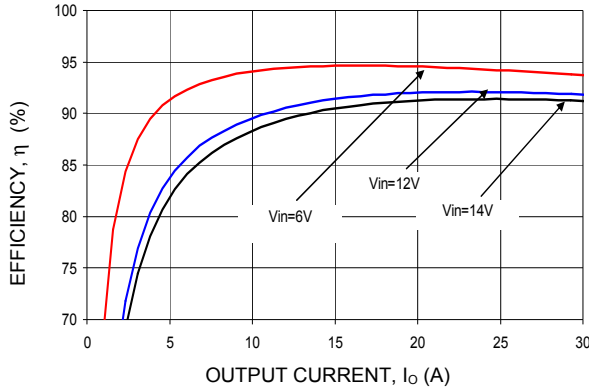

Figure 19. Converter Efficiency versus Output Current.

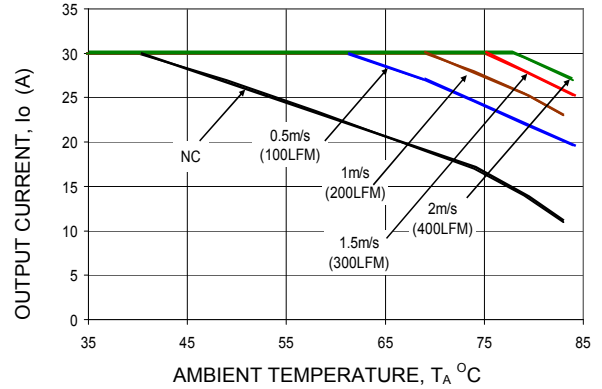

Figure 22. Output Current Derating versus Ambient Temperature and Airflow at 12V in.

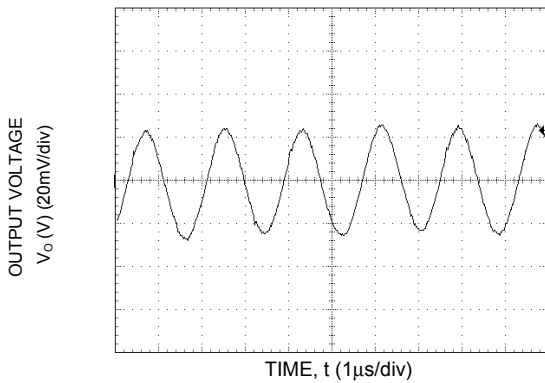

Figure 20. Typical output ripple and noise ( $V_{IN} = 12V$ ,  $I_o = 30A$ ,  $C_{OUT} = 0.1\mu F // 47\mu F$  ceramic capacitors).

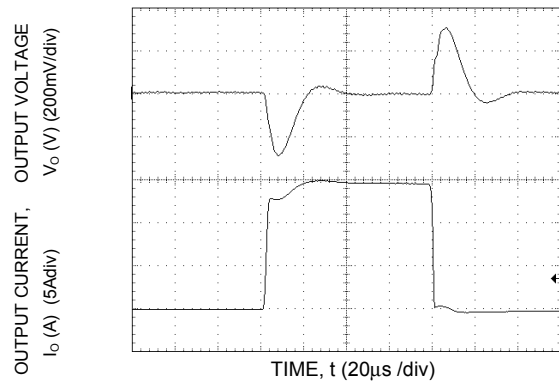

Figure 23. Transient Response to Dynamic Load Change from 0% to 50% to 0% with  $V_{IN}=12V$ .

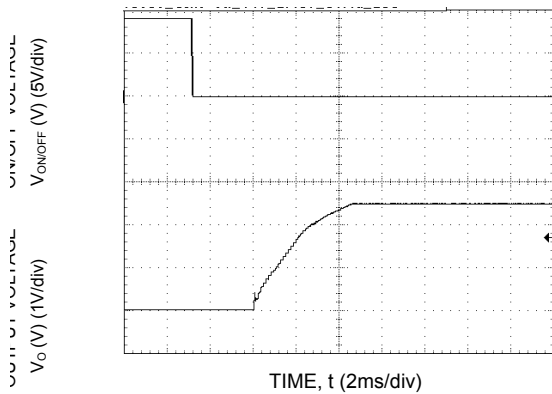

Figure 21. Typical Start-up Using On/Off Voltage ( $I_o = I_{o,max}$ ).

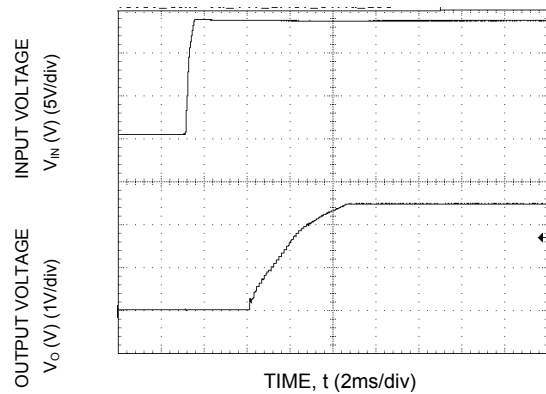

Figure 24. Typical Start-up Using Input Voltage ( $V_{IN} = 14V$ ,  $I_o = I_{o,max}$ ).



### Characteristic Curves

The following figures provide typical characteristics for the APTS030A0X3-SRPHZ at 3.3V out and 25°C.

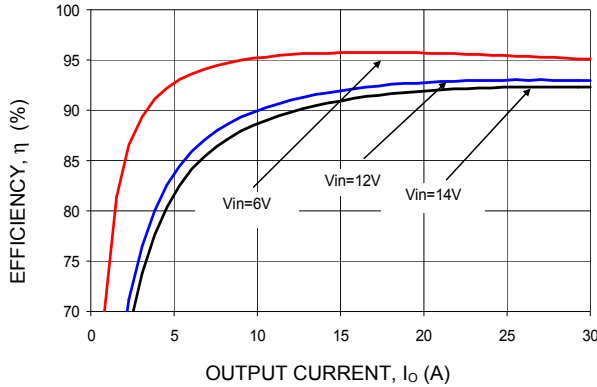

Figure 19. Converter Efficiency versus Output Current.

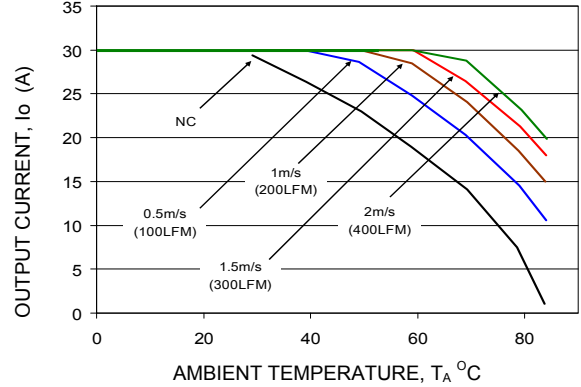

Figure 22. Output Current Derating versus Ambient Temperature and Airflow at 12V in.

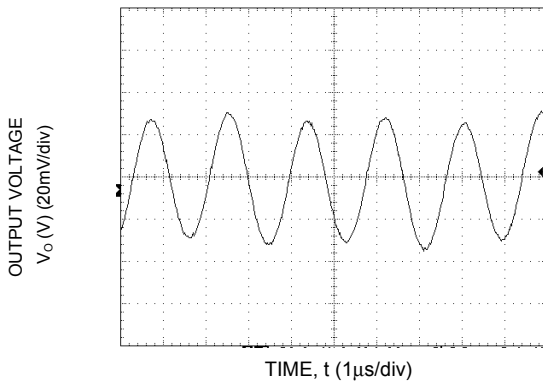

Figure 20. Typical output ripple and noise ( $V_{IN} = 12V$ ,  $I_o = 30A$ ,  $C_{OUT} = 0.1\mu F // 47\mu F$  ceramic capacitors).

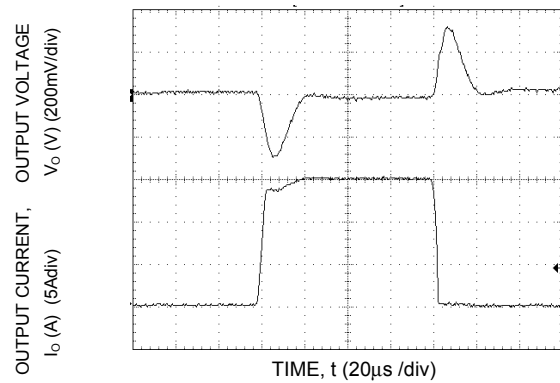

Figure 23. Transient Response to Dynamic Load Change from 0% to 50% to 0% with  $V_{IN}=12V$ .

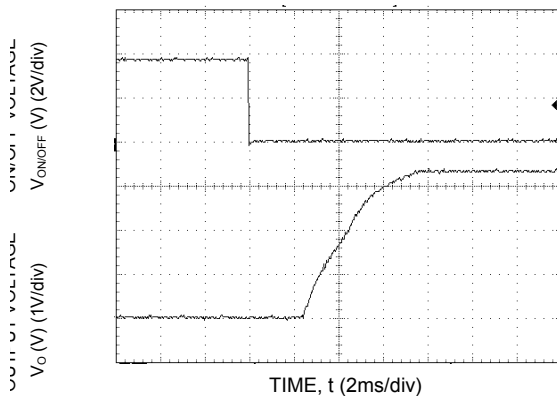

Figure 21. Typical Start-up Using On/Off Voltage ( $I_o = I_{o,max}$ ).

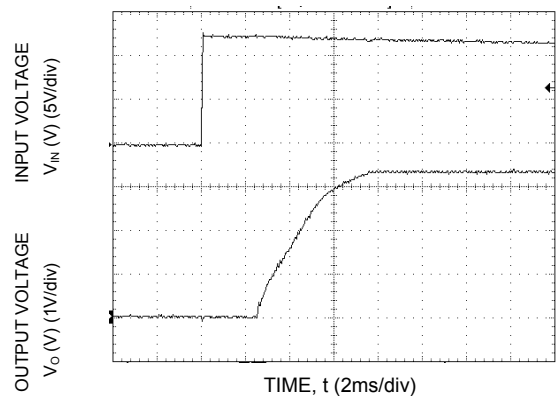
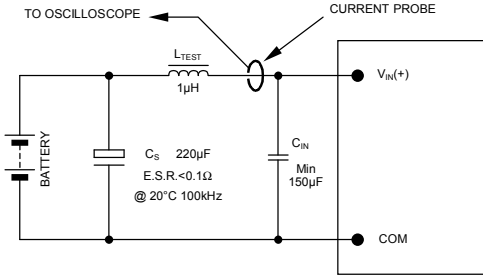

Figure 24. Typical Start-up Using Input Voltage ( $V_{IN} = 14V$ ,  $I_o = I_{o,max}$ ).

## Test Configurations



NOTE: Measure input reflected ripple current with a simulated source inductance ( $L_{TEST}$ ) of 1µH. Capacitor  $C_S$  offsets possible battery impedance. Measure current as shown above.

Figure 25. Input Reflected Ripple Current Test Setup.

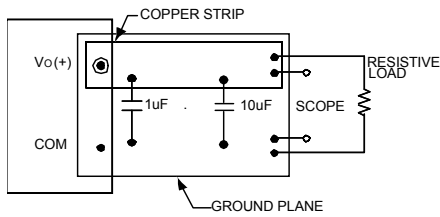

NOTE: All voltage measurements to be taken at the module terminals, as shown above. If sockets are used then Kelvin connections are required at the module terminals to avoid measurement errors due to socket contact resistance.

Figure 26. Output Ripple and Noise Test Setup.

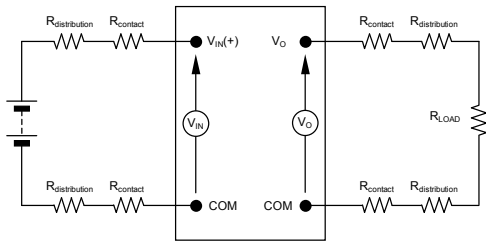

NOTE: All voltage measurements to be taken at the module terminals, as shown above. If sockets are used then Kelvin connections are required at the module terminals to avoid measurement errors due to socket contact resistance.

Figure 27. Output Voltage and Efficiency Test Setup.

$$\text{Efficiency } \eta = \frac{V_O \cdot I_O}{V_{IN} \cdot I_{IN}} \times 100 \%$$

## Design Considerations

The 12V Mega TLynx™ module should be connected to a low-impedance source. A highly inductive source can affect the stability of the module. An input capacitor must be placed directly adjacent to the input pin of the module, to minimize input ripple voltage and ensure module stability.

To minimize input voltage ripple, low-ESR ceramic capacitors are recommended at the input of the module. Figure 28 shows the input ripple voltage for various output voltages at 30A of load current with 1x22 µF, 2x22 µF or 2x47 µF ceramic capacitors and an input of 12V.

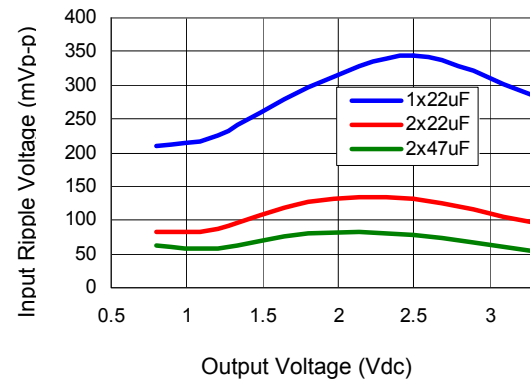

Figure 28. Input ripple voltage for various output voltages with 1x22 µF, 2x22 µF or 2x47 µF ceramic capacitors at the input (30A load). Input voltage is 12V.

## Output Filtering

The 12V Mega TLynx modules are designed for low output ripple voltage and will meet the maximum output ripple specification with no external capacitors. However, additional output filtering may be required by the system designer for a number of reasons. First, there may be a need to further reduce the output ripple and noise of the module. Second, the dynamic response characteristics may need to be customized to a particular load step change.

To reduce the output ripple and improve the dynamic response to a step load change, additional capacitance at the output can be used. Low ESR ceramic and polymer are recommended to improve the dynamic response of the module. For stable operation of the module, limit the capacitance to less than the maximum output capacitance as specified in the electrical specification table. Optimal performance of the module can be achieved by using the Tunable Loop feature described later in this data sheet.

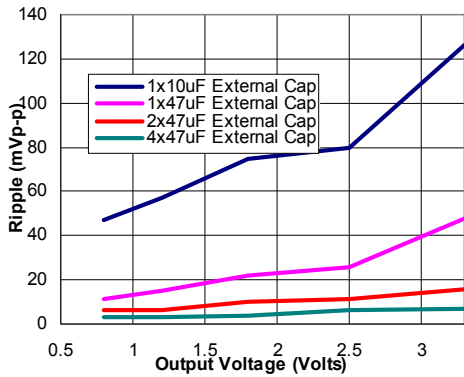

Figure 29. Output ripple voltage for various output voltages with external 1x10  $\mu$ F, 1x47  $\mu$ F, 2x47  $\mu$ F or 4x47  $\mu$ F ceramic capacitors at the output (30A load). Input voltage is 12V.

### Safety Considerations

For safety agency approval the power module must be installed in compliance with the spacing and separation requirements of the end-use safety agency standards, i.e., UL 60950-1 2nd Edition, CSA C22.2 No. 60950-1-07, and VDE 0805-1+A11:2009-11 (DIN EN60950-1 2nd Edition) Licensed. The APTS030A0X were tested using a 30A, time delay fuse in the ungrounded input.

For the converter output to be considered meeting the requirements of safety extra-low voltage (SELV), the input must meet SELV requirements. The power module has extra-low voltage (ELV) outputs when all inputs are ELV. The input to these units is to be provided with a time-delay fuse with a maximum rating of 30A in the positive input lead.

### Feature Descriptions

#### Remote On/Off

The 12V Mega TLynx™ power modules feature a On/Off pin for remote On/Off operation. If not using the On/Off pin, connect the pin to ground (the module will be ON). The On/Off signal ( $V_{on/off}$ ) is referenced to ground. The circuit configuration for remote On/Off operation of the module using the On/Off pin is shown in Figure 30.

During a Logic High on the On/Off pin (transistor Q1 is OFF), the module remains OFF. The external resistor R1 should be chosen to maintain 3.0V minimum on the On/Off pin to ensure that the module is OFF when transistor Q1 is in the OFF state. Suitable values for R1 are 4.7K for input voltage of 12V and 3K for 5Vin. During Logic-Low when Q1 is turned ON, the module is turned ON.

The On/Off pin can also be used to synchronize the output voltage start-up and shutdown of multiple modules in parallel. By connecting On/Off pins of multiple modules, the output start-up can be synchronized (please refer to characterization curves). When On/Off pins are connected together, all modules will shutdown if any one of the modules gets disabled due to undervoltage lockout or over temperature protection.

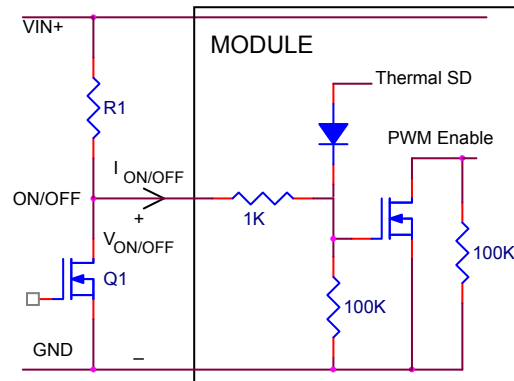

Figure 30. Remote On/Off Implementation using ON/OFF .

#### Overcurrent Protection

To provide protection in a fault (output overload) condition, the unit is equipped with internal current-limiting circuitry and can endure current limiting continuously. At the point of current-limit inception, the unit enters hiccup mode. The unit operates normally once the output current is brought back into its specified range.

### Overtemperature Protection

To provide protection in a fault condition, the unit is equipped with a thermal shutdown circuit. The unit will shutdown if the overtemperature threshold of 125°C is exceeded at the thermal reference point  $T_{ref}$ . The thermal shutdown is not intended as a guarantee that the unit will survive temperatures beyond its rating. Once the unit goes into thermal shutdown it will then wait to cool before attempting to restart.

### Input Undervoltage Lockout

At input voltages below the input undervoltage lockout limit, the module operation is disabled. The module will begin to operate at an input voltage above the undervoltage lockout turn-on threshold.

### Output Voltage Programming

The output voltage of the 12V Mega TLynx™ can be programmed to any voltage from 0.8dc to 3.63Vdc by connecting a resistor (shown as  $R_{trim}$  in Figure 31) between Trim and GND pins of the module. Without an external resistor between Trim and GND pins, the output of the module will be 0.8Vdc. To calculate the value of the trim resistor,  $R_{trim}$  for a desired output voltage, use the following equation:

$$R_{trim} = \left[ \frac{8000}{V_o - 0.8} \right] \Omega$$

$R_{trim}$  is the external resistor in  $\Omega$

$V_o$  is the desired output voltage

By using a  $\pm 0.5\%$  tolerance trim resistor with a TC of  $\pm 100$ ppm, a set point tolerance of  $\pm 1.5\%$  can be achieved as specified in the electrical specification. Table 1 provides  $R_{trim}$  values required for some common output voltages. The POL Programming Tool, available at [www.lineagepower.com](http://www.lineagepower.com) under the Design Tools section, helps determine the required external trim resistor needed for a specific output voltage.

Table 1

$V_{O, set}$ (V)	$R_{trim}$ (K $\Omega$ )
0.8	Open
1.0	40
1.2	20
1.5	11.429
1.8	8
2.5	4.706
3.3	3.2

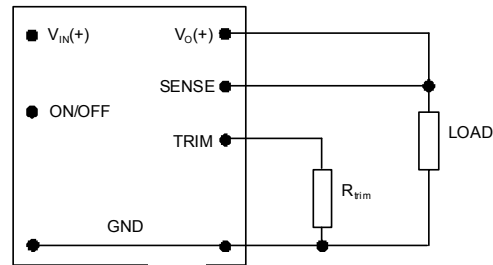

Figure 31. Circuit configuration to program output voltage using an external resistor.

### Remote Sense

The 12V Mega TLynx™ power modules have a Remote Sense feature to minimize the effects of distribution losses by regulating the voltage at the SENSE pin. The voltage between the SENSE pin and VOUT pin must not exceed 0.5V. Note that the output voltage of the module cannot exceed the specified maximum value. This includes the voltage drop between the SENSE and Vout pins. When the Remote Sense feature is not being used, connect the SENSE pin to the VOUT pin.

### Voltage Margining

Output voltage margining can be implemented in the 12V Mega TLynx™ modules by connecting a resistor,  $R_{margin-up}$ , from the Trim pin to the ground pin for margining-up the output voltage and by connecting a resistor,  $R_{margin-down}$ , from the Trim pin to output pin for margining-down. Figure 32 shows the circuit configuration for output voltage margining. The POL Programming Tool, available at [www.lineagepower.com](http://www.lineagepower.com) under the Design Tools section, also calculates the values of  $R_{margin-up}$  and  $R_{margin-down}$  for a specific output voltage and % margin. Please consult your local Lineage Power technical representative for additional details.

### Monotonic Start-up and Shutdown

The 12V Mega TLynx™ modules have monotonic start-up and shutdown behavior for any combination of rated input voltage, output current and operating temperature range.

### Startup into Pre-biased Output

The 12V Mega TLynx™ modules can start into a prebiased output as long as the prebias voltage is 0.5V less than the set output voltage. Note that prebias operation is not supported when output voltage sequencing is used.

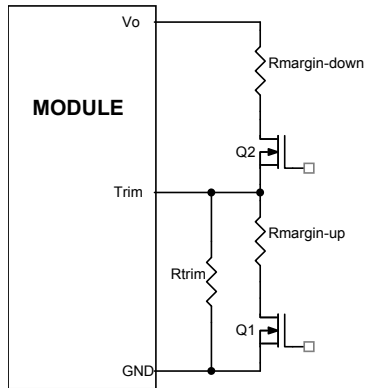

**Figure 32. Circuit Configuration for margining Output voltage.**

### Output Voltage Sequencing

The 12V Mega TLynx™ modules include a sequencing feature, EZ-SEQUENCE™ that enables users to implement various types of output voltage sequencing in their applications. This is accomplished via an additional sequencing pin. When not using the sequencing feature, either tie the SEQ pin to VIN or leave it unconnected.

When an analog voltage is applied to the SEQ pin, the output voltage tracks this voltage until the output reaches the set-point voltage. The final value of the SEQ voltage must be set higher than the set-point voltage of the module. The output voltage follows the voltage on the SEQ pin on a one-to-one basis. By connecting multiple modules together, multiple modules can track their output voltages to the voltage applied on the SEQ pin.

For proper voltage sequencing, first, input voltage is applied to the module. The On/Off pin of the module is left unconnected (or tied to GND for negative logic modules or tied to VIN for positive logic modules) so that the module is ON by default. After applying input voltage to the module, a minimum 10msec delay is required before applying voltage on the SEQ pin. This delay gives the module enough time to complete its internal power-up soft-start cycle. During the delay time, the SEQ pin should be held close to ground (nominally 50mV ± 20 mV). This is required to keep the internal op-amp out of saturation thus preventing output overshoot during the start of the sequencing ramp. By selecting resistor R1 (see fig. 33) according to the following equation

$$R1 = \frac{24950}{V_{IN} - 0.05} \text{ ohms,}$$

the voltage at the sequencing pin will be 50mV when the sequencing signal is at zero.

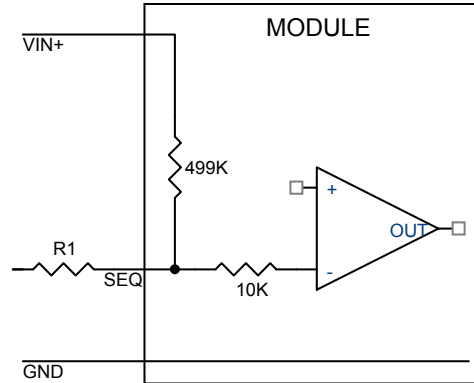

**Figure 33. Circuit showing connection of the sequencing signal to the SEQ pin.**

After the 10msec delay, an analog voltage is applied to the SEQ pin, and the output voltage of the module will track this voltage on a one-to-one volt bases until the output reaches the set-point voltage. To initiate simultaneous shutdown of the modules, the SEQ pin voltage is lowered in a controlled manner. The output voltage of the modules tracks the voltages below their set-point voltages on a one-to-one basis. A valid input voltage must be maintained until the tracking and output voltages reach ground potential.

When using the EZ-SEQUENCE™ feature to control start-up of the module, pre-bias immunity during start-up is disabled. The pre-bias immunity feature of the module relies on the module being in the diode-mode during start-up. When using the EZ-SEQUENCE™ feature, modules goes through an internal set-up time of 10msec, and will be in synchronous rectification mode when the voltage at the SEQ pin is applied. This will result in the module sinking current if a pre-bias voltage is present at the output of the module. When pre-bias immunity during start-up is required, the EZ-SEQUENCE™ feature must be disabled. For additional guidelines on using the EZ-SEQUENCE™ feature please refer to Application Note AN04-008 "Application Guidelines for Non-Isolated Converters: Guidelines for Sequencing of Multiple Modules", or contact the Lineage Power technical representative for additional information.

### Active Load Sharing (-P Option)

For additional power requirements, the 12V Mega TLynx™ power module is also available with a parallel option. Up to five modules can be configured, in parallel, with active load sharing.

Good layout techniques should be observed when using multiple units in parallel. To implement forced load sharing, the following connections should be made:

- The share pins of all units in parallel must be connected together. The path of these connections should be as direct as possible.
- All remote-sense pins should be connected to the power bus at the same point, i.e., connect all the SENSE(+) pins to the (+) side of the bus. Close proximity and directness are necessary for good noise immunity

Some special considerations apply for design of converters in parallel operation:

- When sizing the number of modules required for parallel operation, take note of the fact that current sharing has some tolerance. In addition, under transient conditions such as a dynamic load change and during startup, all converter output currents will not be equal. To allow for such variation and avoid the likelihood of a converter shutting off due to a current overload, the total capacity of the paralleled system should be no more than 75% of the sum of the individual converters. As an example, for a system of four 12V Mega TLynx™ converters in parallel, the total current drawn should be less than 75% of (4 x 30A), i.e. less than 90A.
- All modules should be turned on and off together. This is so that all modules come up at the same time avoiding the problem of one converter sourcing current into the other leading to an overcurrent trip condition. To ensure that all modules come up simultaneously, the on/off pins of all paralleled converters should be tied together and the converters enabled and disabled using the on/off pin.
- The share bus is not designed for redundant operation and the system will be non-functional upon failure of one of the unit when multiple units are in parallel. In particular, if one of the converters shuts down during operation, the other converters may also shut down due to their outputs hitting current limit. In such a situation, unless a coordinated restart is ensured, the system may never properly restart since different converters will try to restart at different times causing an overload condition and subsequent shutdown. This situation can be avoided by having an external output voltage monitor circuit that detects a shutdown condition and forces all converters to shut down and restart together.

When not using the active load sharing feature, share pins should be left unconnected.

### Tunable Loop™

The 12V Mega TLynx™ modules have a new feature that optimizes transient response of the module called Tunable Loop™.

External capacitors are usually added to the output of the module for two reasons: to reduce output ripple and noise (see Fig. 29) and to reduce output voltage deviations from the steady-state value in the presence of dynamic load current changes. Adding external capacitance however affects the voltage control loop of the module, typically causing the loop to slow down with sluggish response. Larger values of external capacitance could also cause the module to become unstable.

The Tunable Loop™ allows the user to externally adjust the voltage control loop to match the filter network connected to the output of the module. The Tunable Loop™ is implemented by connecting a series R-C between the SENSE and TRIM pins of the module, as shown in Fig. 34. This R-C allows the user to externally adjust the voltage loop feedback compensation of the module.

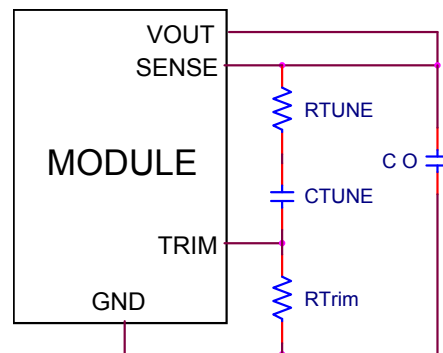

**Figure 34. Circuit diagram showing connection of  $R_{TUNE}$  and  $C_{TUNE}$  to tune the control loop of the module.**

Recommended values of  $R_{TUNE}$  and  $C_{TUNE}$  for different output capacitor combinations are given in Tables 2 and 3. Table 2 shows the recommended values of  $R_{TUNE}$  and  $C_{TUNE}$  for different values of ceramic output capacitors up to 1000uF that might be needed for an application to meet output ripple and noise requirements. Selecting  $R_{TUNE}$  and  $C_{TUNE}$  according to Table 2 will ensure stable operation of the module.

In applications with tight output voltage limits in the presence of dynamic current loading, additional

output capacitance will be required. Table 3 lists recommended values of  $R_{TUNE}$  and  $C_{TUNE}$  in order to meet 2% output voltage deviation limits for some common output voltages in the presence of a 15A to 30A step change (50% of full load), with an input voltage of 12V.

Please contact your Lineage Power technical representative to obtain more details of this feature as well as for guidelines on how to select the right value of external R-C to tune the module for best transient performance and stable operation for other output capacitance values or input voltages other than 12V.

**Table 2. General recommended values of  $R_{TUNE}$  and  $C_{TUNE}$  for  $V_{in}=12V$  and various external ceramic capacitor combinations.**

Co	1x47 $\mu$ F	2x47 $\mu$ F	4x47 $\mu$ F	10x47 $\mu$ F	20x47 $\mu$ F
$R_{TUNE}$	560	390	390	220	220
$C_{TUNE}$	270pF	470pF	820pF	2200pF	4700pF

**Table 3. Recommended values of  $R_{TUNE}$  and  $C_{TUNE}$  to obtain transient deviation of  $\leq 2\%$  of  $V_{out}$  for a 15A step load with  $V_{in}=12V$ .**

Vo	3.3V	2.5V	1.8V	1.2V	0.8V
Co	2x47 $\mu$ F + 3x330 $\mu$ F Polymer	3x47 $\mu$ F + 3x330 $\mu$ F Polymer	3x47 $\mu$ F + 4x330 $\mu$ F Polymer	7x330 $\mu$ F Polymer	2x47 $\mu$ F + 10 x330 $\mu$ F Polymer
$R_{TUNE}$	390	390	330	220	150
$C_{TUNE}$	2200pF	3900pF	6800pF	10nF	56nF
$\Delta V$	66mV	50mV	36mV	24mV	16mV



## Thermal Considerations

Power modules operate in a variety of thermal environments; however, sufficient cooling should always be provided to help ensure reliable operation.

Considerations include ambient temperature, airflow, module power dissipation, and the need for increased reliability. A reduction in the operating temperature of the module will result in an increase in reliability. The thermal data presented here is based on physical measurements taken in a wind tunnel. The test set-up is shown in Figure 35. Note that the airflow is parallel to the short axis of the module as shown in Figure 36. The derating data applies to airflow in either direction of the module's short axis.

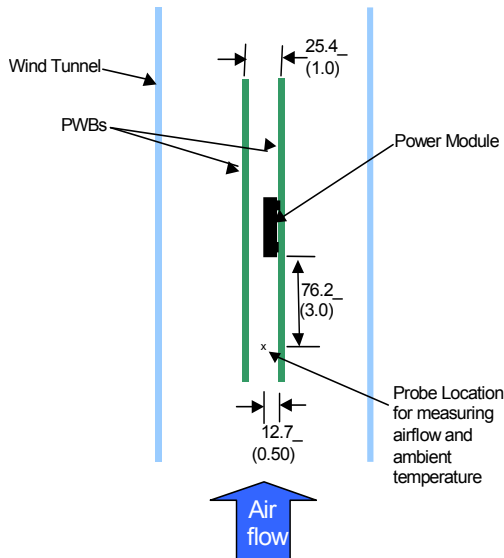

Figure 35. Thermal Test Setup.

The thermal reference points,  $T_{ref}$  used in the specifications is shown in Figure 36. For reliable operation the temperatures at this point should not

exceed 130°C. The output power of the module should not exceed the rated power of the module ( $V_{o,set} \times I_{o,max}$ ).

Please refer to the Application Note “Thermal Characterization Process For Open-Frame Board-Mounted Power Modules” for a detailed discussion of thermal aspects including maximum device temperatures.

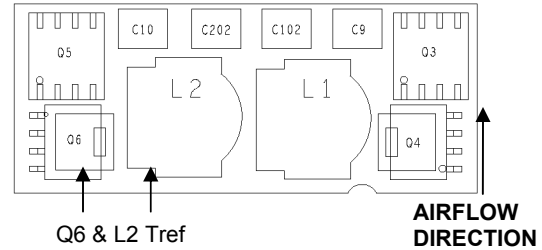

Figure 36. Preferred airflow direction and location of hot-spot of the module ( $T_{ref}$ ).



## Example Application Circuit

### Requirements:

V <sub>in</sub> :	12V
V <sub>out</sub> :	1.8V
I <sub>out</sub> :	22.5A max., worst case load transient is from 15A to 22.5A
ΔV <sub>out</sub> :	1.5% of V <sub>out</sub> (27mV) for worst case load transient
V <sub>in</sub> , ripple	1.5% of V <sub>in</sub> (180mV, p-p)

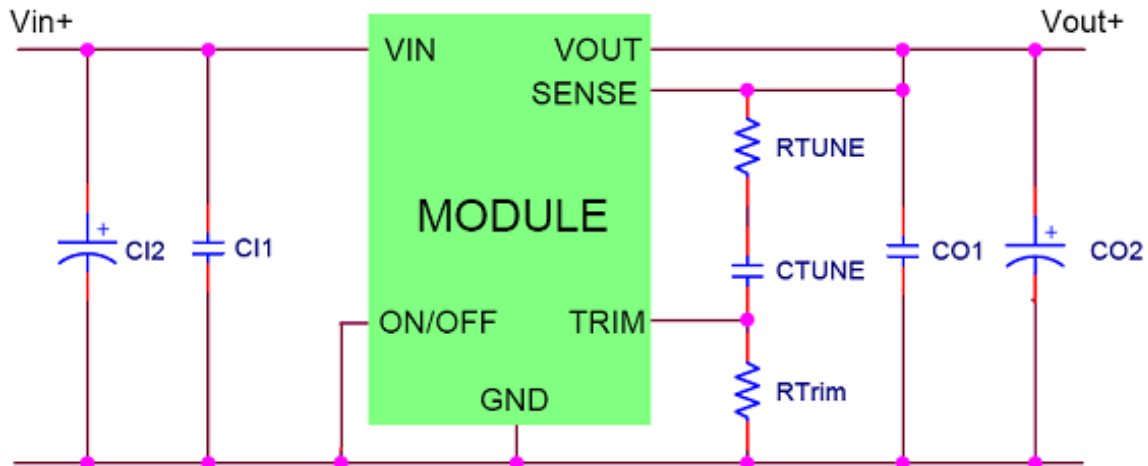

C11	2x22μF/16V ceramic capacitor (e.g. TDK C Series)
C12	100μF/16V bulk electrolytic
CO1	3x47μF/6.3V ceramic capacitor (e.g. TDK C Series, Murata GRM32ER60J476ME20)
CO2	2x470μF/4V Polymer/poscap, Low EST (e.g. Sanyo Poscap 4TPE470MCL/4TPF470ML)
CTune	15nF ceramic capacitor
RTune	430 ohms SMT resistor
RTrim	8kΩ SMT resistor (recommended tolerance of 0.1%)

## Mechanical Outline of Module

Dimensions are in millimeters and (inches).

Tolerances: x.x mm ± 0.5 mm (x.xx in. ± 0.02 in.) [unless otherwise indicated]

x.xx mm ± 0.25 mm (x.xxx in ± 0.010 in.)

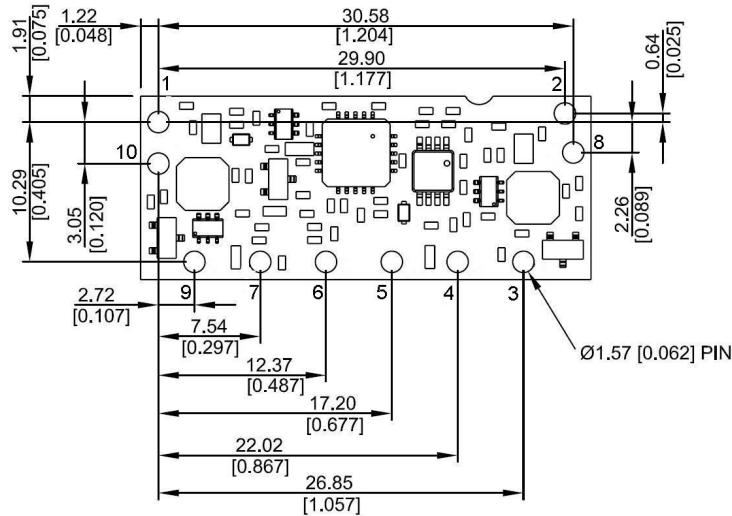

Pin No.	Function
1	On/Off
2	V <sub>IN</sub>
3	SEQ
4	GND
5	V <sub>OUT</sub>
6	TRIM
7	SENSE
8	GND
9	SHARE
10	GND

**BOTTOM VIEW**

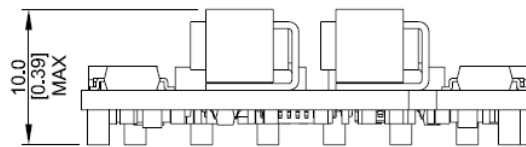

**SIDE VIEW**

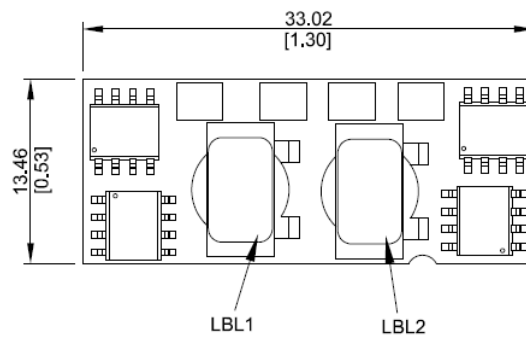

**TOP VIEW**

Co-planarity (max) : 0.102[0.004]

### Recommended Pad Layout

Dimensions are in millimeters and (inches).

Tolerances: x.x mm ± 0.5 mm (x.xx in. ± 0.02 in.) [unless otherwise indicated]

x.xx mm ± 0.25 mm (x.xxx in ± 0.010 in.)

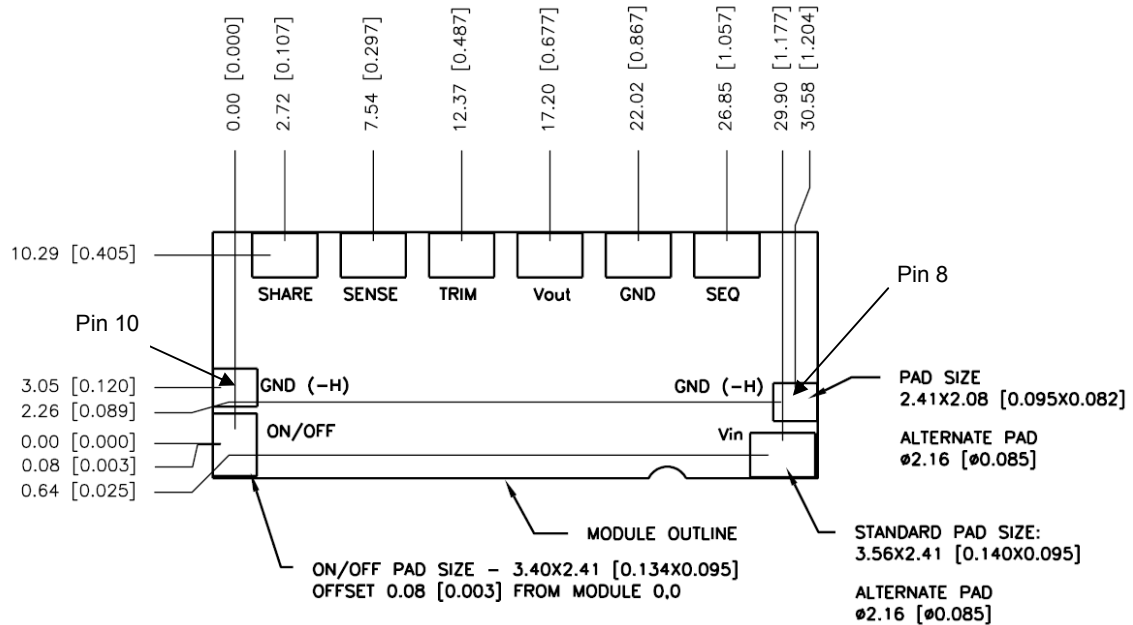

PIN	FUNCTION	PIN	FUNCTION
1	On/Off	6	Trim
2	VIN	7	Sense
3	SEQ	8	GND
4	GND	9	SHARE
5	VOUT	10	GND

## Packaging Details

The 12V Mega TLynx™ SMT version is supplied in tape & reel as standard. Modules are shipped in quantities of 200 modules per reel.

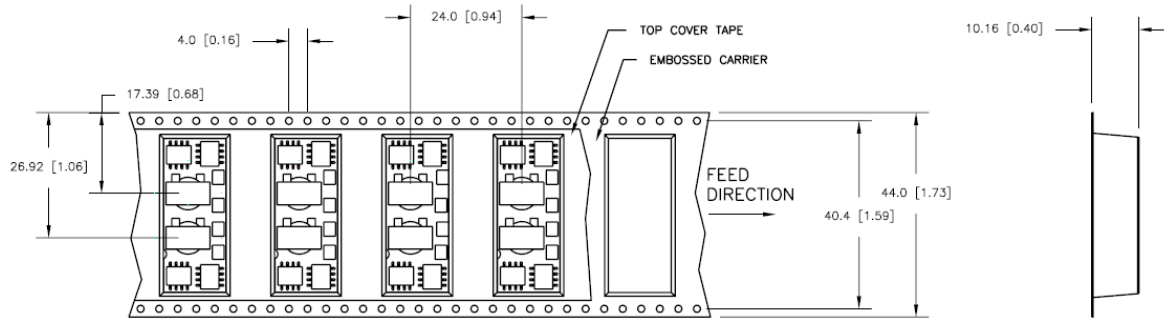

NOTE: CONFORMS TO EIA-481 STANDARD



All Dimensions are in millimeters and (in inches).

### Reel Dimensions

Outside diameter: 330.2 (13.0)  
Inside diameter: 177.8 (7.0)  
Tape Width: 44.0 (1.73)

## Surface Mount Information

### Pick and Place

The 12V Mega TLynx™ SMT modules use an open frame construction and are designed for a fully automated assembly process. The modules are fitted with a label designed to provide a large surface area for pick and place operations. The label meets all the requirements for surface mount processing, as well as safety standards, and is able to withstand reflow temperatures of up to 300°C. The label also carries product information such as product code, serial number and location of manufacture.

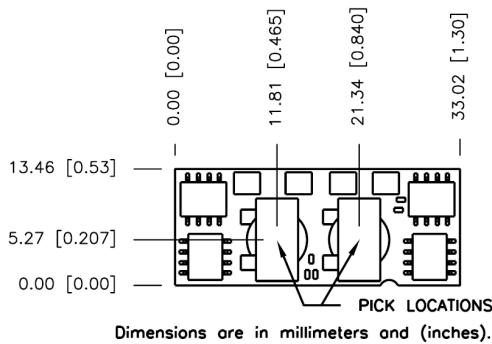

Figure 37. Pick and Place Location.

### Nozzle Recommendations

The module weight has been kept to a minimum by using open frame construction. Even so, these modules have a relatively large mass when compared to conventional SMT components. Variables such as nozzle size, tip style, vacuum pressure and pick & placement speed should be considered to optimize this process. The minimum recommended inside nozzle diameter for reliable operation is 3mm. The maximum nozzle outer diameter, which will safely fit within the allowable component spacing, is 5 mm max.

### Bottom Side Assembly

This module is not recommended for assembly on the bottom side of a customer board. If such an assembly is attempted, components may fall off the module during the second reflow process. If assembly on the bottom side is planned, please contact Lineage Power for special manufacturing process instructions.

### Lead-free (Pb-free) Soldering

The -Z version Mega TLynx modules are lead-free (Pb-free) and RoHS compliant and are both

forward and backward compatible in a Pb-free and a SnPb soldering process. Failure to observe the instructions below may result in the failure of or cause damage to the modules and can adversely affect long-term reliability.

### Pb-free Reflow Profile

Power Systems will comply with J-STD-020 Rev. C (Moisture/Reflow Sensitivity Classification for Nonhermetic Solid State Surface Mount Devices) for both Pb-free solder profiles and MSL classification procedures. This standard provides a recommended forced-air-convection reflow profile based on the volume and thickness of the package (table 4-2). The suggested Pb-free solder paste is Sn/Ag/Cu (SAC).

Recommended linear reflow profile using Sn/Ag/Cu solder:

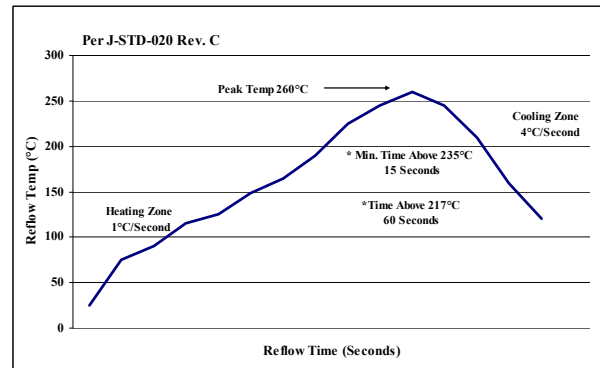

**NOTE:** Soldering outside of the recommended profile requires testing to verify results and performance.

### Tin Lead Soldering

The 12V Mega TLynx™ SMT power modules are lead free modules and can be soldered either in a lead-free solder process or in a conventional Tin/Lead (Sn/Pb) process. It is recommended that the customer review data sheets in order to customize the solder reflow profile for each application board assembly. The following instructions must be observed when soldering these units. Failure to observe these instructions may result in the failure of or cause damage to the modules, and can adversely affect long-term reliability.

In a conventional Tin/Lead (Sn/Pb) solder process peak reflow temperatures are limited to less than 235°C. Typically, the eutectic solder melts at 183°C, wets the land, and subsequently wicks the device connection. Sufficient time must be allowed to fuse the plating on the connection to ensure a reliable solder joint. There are several types of SMT reflow technologies currently used in the industry. These surface mount power modules can be reliably soldered using natural forced convection, IR (radiant infrared), or a combination of convection/IR. For reliable soldering the solder reflow profile should be established by accurately measuring the modules CP connector temperatures.

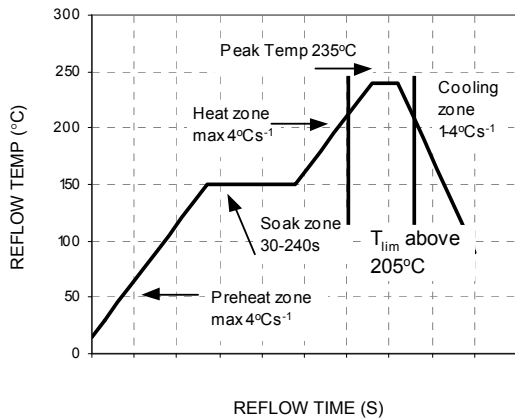

Figure 38. Reflow Profile for Tin/Lead (Sn/Pb) process.

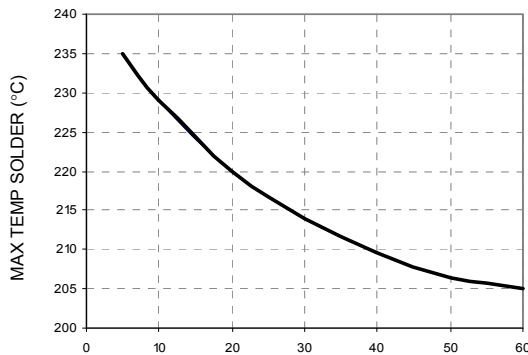

Figure 39. Time Limit Curve Above 205°C Reflow for Tin Lead (Sn/Pb) process.

### MSL Rating

The 12V Mega TLynx™ SMT modules have a MSL rating of 2.

### Storage and Handling

The recommended storage environment and handling procedures for moisture-sensitive surface mount packages is detailed in J-STD-033 Rev. A (Handling, Packing, Shipping and Use of Moisture/Reflow Sensitive Surface Mount Devices). Moisture barrier bags (MBB) with desiccant are required for MSL ratings of 2 or greater. These sealed packages should not be broken until time of use. Once the original package is broken, the floor life of the product at conditions of ≤ 30°C and 60% relative humidity varies according to the MSL rating (see J-STD-033A). The shelf life for dry packed SMT packages will be a minimum of 12 months from the bag seal date, when stored at the following conditions: < 40° C, < 90% relative humidity.

### Post Solder Cleaning and Drying Considerations

Post solder cleaning is usually the final circuit-board assembly process prior to electrical board testing. The result of inadequate cleaning and drying can affect both the reliability of a power module and the testability of the finished circuit-board assembly. For guidance on appropriate soldering, cleaning and drying procedures, refer to *Board Mounted Power Modules: Soldering and Cleaning* Application Note (AN04-001).

## Ordering Information

Table 4. Device Codes

Product codes	Input Voltage	Output Voltage	Output Current	On/Off Logic	Connector Type	Comcodes
APTS030A0X3-SRPHZ	6.0 – 14Vdc	0.8 – 3.63Vdc	30A	Negative	SMT	CC109138351

Table 5. Coding Scheme

TLynx family	Sequencing feature.	Input voltage range	Output current	Output voltage	Options	ROHS Compliance
AP	T	S	030A0	X	-SR	Z
	T = with Seq.	S = 6 - 14V	30A	X = programmable output	S = Surface Mount R = Tape&Reel P = Paralleling	Z = ROHS6

Table 6. Device Options

Option	Device Code Suffix
Current Share	-P
2 Extra ground pins	-H
RoHS Compliant	-Z



**LINEAGE POWER**®

**World Wide Headquarters**  
Lineage Power Corporation  
601 Shiloh Road, Plano, TX 75074, USA  
**+1-888-LINEAGE(546-3243)**  
(Outside U.S.A.: **+1-972-244-WATT(9288)**)  
**www.lineagepower.com**  
**e-mail: techsupport1@lineagepower.com**

**Asia-Pacific Headquarters**  
Tel: +86.021.54279977\*808

**Europe, Middle-East and Africa Headquarters**  
Tel: +49.89.878067-280

**India Headquarters**  
Tel: +91.80.28411633

Lineage Power reserves the right to make changes to the product(s) or information contained herein without notice. No liability is assumed as a result of their use or application. No rights under any patent accompany the sale of any such product(s) or information.

Lineage Power DC-DC products are protected under various patents. Information on these patents is available at [www.lineagepower.com/patents](http://www.lineagepower.com/patents).

© 2010 Lineage Power Corporation, (Plano, Texas) All International Rights Reserved.