

## Universal polyester cabinets



### Standards

EN/IEC 61439-2  
EN/IEC 60529  
EN/IEC 62262  
EN/IEC 62208

### Approvals



UL types 3, 3R, 3S, 4, 4X,  
12 and 13  
Available on request



CSA types 3, 3R, 3S, 4, 4X,  
12 and 13  
Available on request

LR - Lloyd's Register of Shipping  
(IP66 central lock versions)

### Features

- The range is available in seven sizes, ranging from 315 x 215 to 1035 x 835 mm.
- The cabinets are made of light-grey (RAL 7035) hot moulded, glass fibre reinforced polyester, dyed in mass. The enclosure is furnished with four threaded studs and bolts for mounting plate or mounting frame installation.
- The enclosure provides total insulation and a protection degree of **IP65/66** following EN/IEC 62208.
- Protection degree IK08 against external mechanical impacts according to EN/IEC 62208 (IK07 for cabinets with glazed door).
- Resists temperatures from -25°C up to 70°C in continuous use (peak temperatures up to 130°C).
- Self extinguishing and halogen-free.
- Rated insulation voltage  $U_i = 1000V$ .

### Applications

- |                                                 |                        |
|-------------------------------------------------|------------------------|
| - Heavy industry                                | - Brewery              |
| - Steel mills                                   | - Public services      |
| - Petrochemical plants                          | - Street signalisation |
| - Temporary connection (for construction sites) | - Telecom              |
|                                                 | - Photovoltaic energy  |



Overview of the range ● Page B.3

Dimensional drawings ● Page I.20

Specifications for tender documents ● Page I.53

Power dissipation values ● Page I.70



- ① Housing in one piece
- ② Removable door: left- or right-hand hinged (not for version with swing-handle)
- ③ Slightly curved gasket-slot avoiding water stagnation
- ④ Fixing points at rear of door
- ⑤ Cover plate:
  - polyester RAL 7035
  - hinged (hinge set 831010 needed)
  - independent
  - reversible (30mm different build-in depth)
  - sealable
  - with 90° locking pin
- ⑥ Three point closing system with one lock. Exchangeable locks.
- ⑦ Independent rail for terminal blocks
- ⑧ Mounting frame
  - removable
  - predrilled
  - reinforced DIN-rails
- ⑨ Integrated hinges. Door opens 180°
- ⑩ Mounting plate
  - metal
  - hard paper
  - perforated
- ⑪ Direct wall fixing points or wall fixing lugs in plastic material or stainless steel.

# ARIA

- Monobloc type of cabinet
- In and outdoor use
- 7 dimensions 315 x 215 x 170 up to 1035 x 835 x 300 mm
- 1, 2 or 3 point locking mechanism
- Glass fibre reinforced polyester
- Protection degree **IP65/66**-IK08 (plain door)
- Fitted for mounting plate and modular mounting frame
- Wall mounting/pole fixing
- Approvals: UL/CSA/Lloyd's Register

### Self-adhesive rainhood

(as a standard accessory with each cabinet)  
avoiding dripping water drops while opening the door

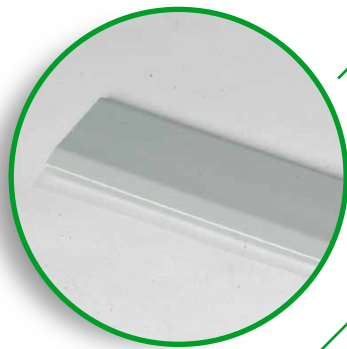

### Mounting frame with individual modular cover plates for DIN-rail equipment

150 mm between centres, up to 180 modules!  
Closed cover plates for mounting plate assembly.



Construction



Petrochemicals



Conveyer belts



Durable polyurethane gasket



**Ergonomic closing mechanism**

- Various lock inserts and handles available
- Can also be operated by swing-handle for profile half cylinder

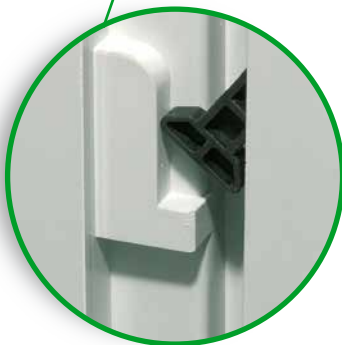

**Patented doorlifter**  
for bigger dimensions  
(ARIA 75 and larger) ensuring the  
door takes it's center  
position during closing



Traffic



Water treatment



Camping and Hotels

## Universal polyester cabinets



		Type	ARIA 32	ARIA 43	ARIA 54	ARIA 64
		HxWxD	315x215x170	415x315x170	515x415x230	615x415x230
	Cabinet □ IP65 - IK08 With double bit lock 3 mm	Ref. No.	-	-	831809 2-point	831810 2-point
		Ref. No.	831025 <sup>(1)</sup>	831036	831052	831065
	Cabinet □ IP66 - IK08 With central double bit lock 3 mm	Ref. No.	831307 <sup>(1)</sup>	831034	831051	831064
		Ref. No.	-	-	831812 2-point	831813 2-point
	Glazed door cabinet □ IP65 - IK07 With double bit lock 3 mm	Ref. No.	-	831815	831129	831130
		Ref. No.	-	-	831284	831285
	Glazed door cabinet □ IP66 - IK07 With central double bit lock 3 mm	Ref. No.	-	-	831284	831285
		Ref. No.	-	-	-	-
	Glazed door cabinet □ IP66 - IK07 With central swing handle for profile half cylinder	Ref. No.	-	-	831284	831285
		Ref. No.	-	-	-	-
	Glazed door cabinet □ IP66 - IK07 With central swing handle for profile half cylinder	Ref. No.	-	-	831284	831285
		Ref. No.	-	-	-	-

(1) 1 point locking mechanism, no closing rod  
Pack: 1









## Applications

- Industry
- Steel works
- Oil refineries
- Breweries
- Shipyards
- Public utilities
- Photovoltaic energy
- Heavy industry

		
<b>ARIA 75</b>	<b>ARIA 86</b>	<b>ARIA 108</b>
735×535×270	835×635×300	1035×835×300
<b>831811</b> 2-point	<b>831059</b> 2-point	<b>831073</b> 2-point
<b>831081</b>	<b>831098</b>	<b>831112</b>
<b>831080</b>	<b>831097</b>	<b>831111</b>
<b>831814</b> 2-point	-	-
<b>831131</b>	<b>831132</b>	<b>831133</b>
<b>831286</b>	<b>831287</b>	<b>831288</b>



## Universal polyester cabinets - Accessories

						
	Type		ARIA 32	ARIA 43	ARIA 54	ARIA 64
	HxWxD		315x215x170	415x315x170	515x415x230	615x415x230
	<b>Mounting plates</b>	HxW	250x150	350x250	450x350	550x350
	Hard paper 5 mm	Ref. No.	831027	831038	831054	831067
	Sendzimir zinc coated sheet steel 2 mm	Ref. No.	831026	831037	831053	831066
	Metal perforated 1.5 mm	Ref. No.	831332	831333	831334	831335
	<b>Mounting frame</b>	Ref. No.	831030	831041	831057	831070 <sup>(1)</sup>
	DIN-rails		2	2	3	3
	Modules		12	24	54	54
	<b>Rail for terminal blocks</b>	Ref. No.	831018	831019	831020	831020
	Available spaces for terminal		2	3	4	4
	<b>Full cover plates</b>					
	Plain	Ref. No.	831028	831039	831055	831068
	With cut-outs for DIN-rail equipment	Ref. No.	831029	831040	831056	831069 <sup>(1)</sup>
	With cut-out for individual modular cover plates	Ref. No.	-	831790	831791	831792
	Number of ind. mod. cover plates containable		-	2	3	3
	<b>Individual modular cover plates IP20 (PVC)</b>	HxW	-	150x239	150x343	150x343
	Plain	Ref. No.	-	831797	831799	831801
	With cut-out for DIN-rail equipment	Ref. No.	-	831796	831798	831800
	Modules		-	12	17	18

Pack: 1

(1) Cover plate for ARIA 64 with 3 open and one closed cut-out: 831806 - 72TE  
Mounting frame for ARIA 64 with 4 DIN-rails 831807 - 72TE

ARIA 75	ARIA 86	ARIA 108
735×535×270	835×635×300	1035×835×300
650×450	750×550	950×750
<b>831083</b> <b>831082</b>	<b>831100</b> <b>831099</b>	<b>831114</b> <b>831113</b>
<b>831336</b>	<b>831337</b>	<b>831338</b>
<b>831086</b>	<b>831103</b>	<b>831117</b>
4 88	4 96	5 180
<b>831021</b>	<b>831022</b>	<b>831023</b>
6	7	10
<b>831084</b>	<b>831101</b>	<b>831115</b>
<b>831085</b>	<b>831102</b>	<b>831116</b>
<b>831793</b>	<b>831794</b>	<b>831795</b>
4	8	10
150×423	150×239	150×343
<b>831803</b>	<b>831797</b>	<b>831801</b>
<b>831802</b>	<b>831796</b>	<b>831800</b>
22	12	18

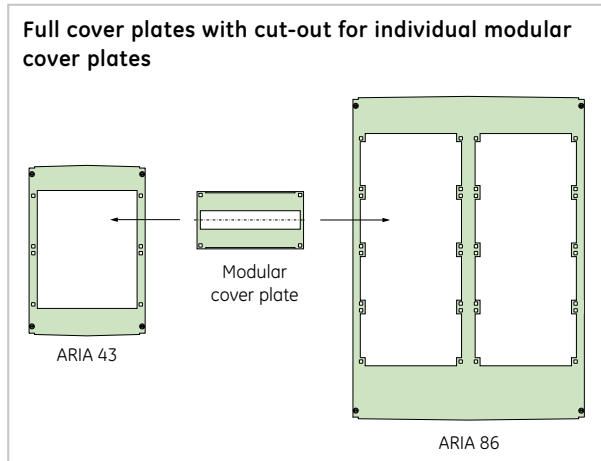

The cabinets ARIA 43 and 86 as well as ARIA 64 and 108 contain the same individual modular cover plates (plain and with cut-out).



Common accessories



Lock inserts		
To replace double-bit inserts from standard delivery		
	<b>831008</b>	1
3 mm		
	<b>831005</b>	1
8 mm		
	<b>831006</b>	1
8 mm		
	<b>831007</b>	1
11 mm		
Other locks on request.		

Fixing lugs		
	<b>831000</b>	1
Set of 4 fixing lugs. 304 stainless steel.		
	<b>831001</b>	1
Set of 4 fixing lugs in polyamide		

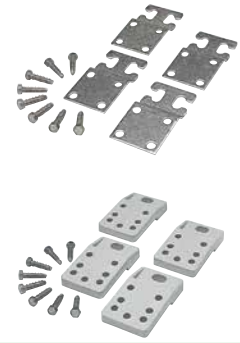

Hinge supports for inner door		
	<b>831010</b>	1
Set of 2 hinge supports for cover plate. Together with a closed cover plate an inner door can be realised.		



Handles <sup>(1)</sup>		
①	<b>831003</b>	1
Neutral handle		
①	<b>831004</b>	1
Handle with lock and 2 keys V2432E		
①	<b>831180</b>	1
Handle with lock and 2 keys 1242E		
①	<b>831152</b>	1
Handle with lock and 2 keys 405E		
①	<b>831153</b>	1
Handle with lock and 2 keys 455E		

Profile half cylinder locks		
Standard: D = 40 mm - L = 30,5 mm		
	<b>832030</b>	1
With 2 keys V2432-E		
	<b>832741</b>	2
Spare keys for 832030		
	<b>832031</b>	1
With 2 keys 1242-E		
	<b>832465</b>	1
With 2 keys 455-E		
	<b>832466</b>	1
With 2 keys 405-E		
	<b>832032</b>	1
With 1 square key, 8 mm		
	<b>832033</b>	1
With 1 triangular key, 8 mm		
	<b>832034</b>	1
With 1 triangular key, 11 mm		
	<b>832029</b>	1
With 1 double-bit key, 3 mm		

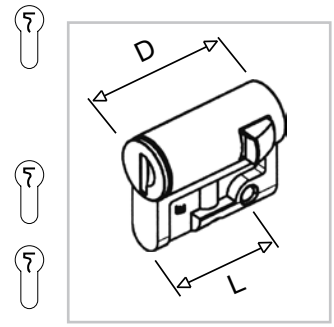

②	<b>831821</b>	1
Handle for profile half cylinder, 40 mm (As spare part or replacement for ARIA 54 and larger - in case of new replacing double-bit lock a mechanical operation at the door is necessary)		
②	<b>843000</b>	1
Handle for profile half cylinder, 45 mm (As spare part or replacement for ARIA 54 and larger - in case of new replacing double-bit lock a mechanical operation at the door is necessary)		



③	<b>831822</b>	1
Handle for profile half cylinder for padlocking (As spare part or replacement for ARIA 54 and larger - in case of new replacing double-bit lock a mechanical operation at the door is necessary)		

Ventilation grids		
	<b>831009</b>	1
(IP44 when mounted in the double corner on ARIA)		
Set of two ventilation grids		
Drilling Ø 34,9 mm		
Please refer to chapter "Climate control" for more ventilation options.		



(1) Handles type 1 can be mounted instead of the double-bit insert without mechanical modification of the door cut-out.



Common accessories (continued)



<b>Supporting chair</b>		
	<b>891854</b>	<b>1</b>

For ARIA 75 and 86, for temporary connections

<b>Blanking plate</b>		
	<b>610142</b>	<b>4</b>

For 4 modules

	<b>610484</b>	<b>500</b>
--	---------------	------------

For 4 modules



<b>Marking strip</b>		
	<b>851321</b>	<b>1m</b>

Self adhesive



<b>Pole mounting set</b>		
	<b>891608</b>	<b>1</b>

For ARIA 54/64  
Stainless steel fixing lugs are included.  
Pole mounting with steel band (not included)

<b>Document pocket</b>		
	<b>811516</b>	<b>1</b>

DIN A4 - W x H = 325 x 180 mm

	<b>832000</b>	<b>1</b>
--	---------------	----------

DIN A5 - W x H = 155 x 225 mm

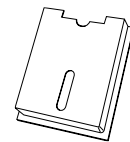

<b>Branch terminals</b>		
6 x 10 mm <sup>2</sup> + 2 x 16 mm <sup>2</sup>		
to clip on 12 x 2 mm bar		
	<b>610185</b>	<b>4</b>

Phase bar - black

	<b>610186</b>	<b>4</b>
--	---------------	----------

Earth bar - green

	<b>610187</b>	<b>4</b>
--	---------------	----------

Neutral bar - blue

<b>Nuts</b>		
For perforated mounting plates		
	<b>831328</b>	<b>50</b>

M4

	<b>831329</b>	<b>50</b>
--	---------------	-----------

M5

	<b>831330</b>	<b>50</b>
--	---------------	-----------

M6

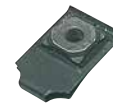

<b>Rain edge (spare part)</b>		
	<b>831530</b>	<b>1</b>

Length 415mm for ARIA 54 and 64;  
can be used for ARIA 32 and 43 when cut to the right length.

	<b>834533</b>	<b>1</b>
--	---------------	----------

Length 835mm for ARIA 108;  
can be used for ARIA 75 and 86 when cut to the right length.

<b>Hinge pins (spare part)</b>		
	<b>831653</b>	<b>20</b>

Length 66mm, for ARIA 32

	<b>831652</b>	<b>20</b>
--	---------------	-----------

Length 100,5mm, for ARIA 43, 54 and 64

	<b>831953</b>	<b>10</b>
--	---------------	-----------

Length 131,5mm, for ARIA 75, 86 and 108



<b>Concrete base</b>		
	<b>891508</b>	<b>1</b>

Suitable for ARIA 54 and ARIA 64.