

Compact Power Line Shelves

Dual I²C Shelves for the GP100 rectifier

Model: J2014001L601



Features

- Mounts into standard 19" EIA-310-D racks
- Isolated output feed may be grounded at either polarity
- +5V standby power isolated from the main output
- Adjustable mounting ears for flush or set back positions.
- Supports hot-swapping of modules
- Accommodates mechanical latching into the slot
- Communicates via PMBus™ compliant dual, redundant I²C
- Designed to pass Zone 4 earthquake requirements when integrated into a seismic rated system or rack
- CUR**† recognized
- CB report
- CE Mark§
- Shock & Vibration: Meets IPC 9562 Class II standards

Purpose

The J2014001L601 shelf provides the supporting enclosure for the GP100H3 family of 6000W 'Global Platform' rectifiers supporting dual-redundant I²C communications. Designed to be mounted into standard 19" enclosures, the shelf comes with adjustable mounting ears that provide either flush-front or further-forward positioned arrangements. The rugged enclosure passes Zone 4 earthquake rating.

* UL is a registered trademark of Underwriters Laboratories, Inc.

† CSA is a registered trademark of Canadian Standards Association.

§ This product is intended for integration into end-user equipment. All CE marking procedures of end-user equipment should be followed. (The CE mark is placed on selected products.)

** ISO is a registered trademark of the International Organization of Standards



Compact Power Line Shelves
Dual I²C shelves for the GP100 rectifier
 Model: J2014001L601

Absolute Maximum Ratings

Stresses in excess of the absolute maximum ratings can cause permanent damage to the device. These are absolute stress ratings only; functional operation of the device is not implied at these or any other conditions in excess of those given in the operations sections of the data sheet. Exposure to absolute maximum ratings for extended periods can adversely affect the device reliability.

Parameter	Symbol	Min	Max	Unit
Input Voltage: Continuous	V _{IN}	0	600	V _{AC}
Operating Ambient Temperature	T _A	-10	75 ¹	°C
Storage Temperature	T _{stg}	-40	85	°C
I/O Isolation voltage to Frame (100% factory Hi-Pot tested)			2087	V _{AC}

Electrical Specifications

Unless otherwise indicated, specifications apply over all operating input voltage, load, and temperature conditions.

INPUT					
Parameter	Symbol	Min	Typ	Max	Unit
Operational Range	V _{IN}	320	380/480	530	V _{AC}
Frequency Range	F _{IN}	47	50/60	63	Hz
AC Input Current, (3Φ - all phases operational)	I _{IN}			15	A _{AC}
Recommended AC Breaker Size			10 15		A _{AC}
					@ 480V _{AC} @ 380V _{AC}
Leakage Current (per Φ, 530VAC, 60Hz)	I _{IN}		2.5	3.5	mA
Isolation (per EN60950)					
	Input – Output	3000			V _{AC}
	Input-Chassis/Signals	2000			V _{AC}

MAIN OUTPUT					
Parameter	Symbol	Min	Typ	Max	Unit
Output Power	W	0	-	12,000	W
Factory set default set point	V		54/48		V _{DC}
Max output current	I _{OUT}			250	A _{DC}
Isolation Output/frame – other circuits	V	100			V _{DC}

AUXILIARY OUTPUT					
Parameter	Symbol	Min	Typ	Max	Unit
Set point	V _{OUT}		5.0		V _{DC}
Output current	I _{OUT}	0		4	A _{DC}
Isolation Output/Frame	V	50			V _{DC}
Output/Main output	V	50			V _{DC}

¹ See the derating guidelines published in the rectifier data sheet

Compact Power Line Shelves
Dual I²C shelves for the GP100 rectifier
 Model: J2014001L601

General Specifications

Parameter	Min	Typ	Max	Units	Notes
Reliability		TBD		Hrs	Full load, 25°C ; MTBF per SR232 Reliability protection for electronic equipment, issue 2, method I, case III,
Service Life		10		Yrs	Full load, excluding fans
Unpacked Weight		4.76/10.5		Kgs/Lbs	
Packed Weight		5.67/12.5		Kgs/Lbs	
Safety/Standards Compliance					
Safety Standards	UL60950-1, CAN/CSA C22.2 No 60950-1, EN60950-1				
Certification Marks	CE mark, UL Recognized (Canada and U.S.)				

Environmental Specifications

Parameter	Min	Typ	Max	Units	Notes	
Ambient Temperature						
	Operating	-10		55	°C	
	Storage	-40		85	°C	
Humidity	Operating	5		95	%	Relative humidity, non-condensing
	Storage	5		95		
Shock and Vibration acceleration			6	Grms	NEBS GR-63-CORE, Level 3, 20 -2000Hz, min 30 minutes	
Earthquake Rating	4			Zone	NEBS GR-63-CORE, all floors, Seismic Zone 4 Designed and tested to meet NEBS specifications.	

EMC²

Parameter	Criteria	Standard	Level	Test
Conducted emissions	AC input	EN55022, FCC Docket 20780 part 15, subpart J EN61000-3-2 Meets Telcordia GR1089-CORE by a 6dB margin	A	0.15 – 30MHz 0 – 2 KHz
Radiated emissions		EN55022 by a 6dB margin	A	30 – 10000MHz
Lightning surge	AC input	EN61000-4-5, Level 4, 1.2/50µs – error free	A	4kV, common mode
			A	2kV, differential mode
		ANSI C62.41 - damage free	A3	6kV, common & differential
Fast transients	Input immunity	EN61000-4-4, Level 3	B	5/50ns, 2kV (common mode)
Conducted RF fields	Enclosure immunity	EN61000-4-6, Level 3	A	130dBµV, 0.15-80MHz, 80% AM
Radiated RF fields		EN61000-4-3, Level 3	A	10V/m, 80-1000MHz, 80% AM
		ENV 50140	A	
ESD	AC input & DC output	EN61000-4-2, Level 3	B	6kV contact, 8kV air

² The shelf design does not preclude the embedded module from meeting the EMC requirements specified in this section.

Compact Power Line Shelves
Dual I²C shelves for the GP100 rectifier
 Model: J2014001L601

Shelf terminations

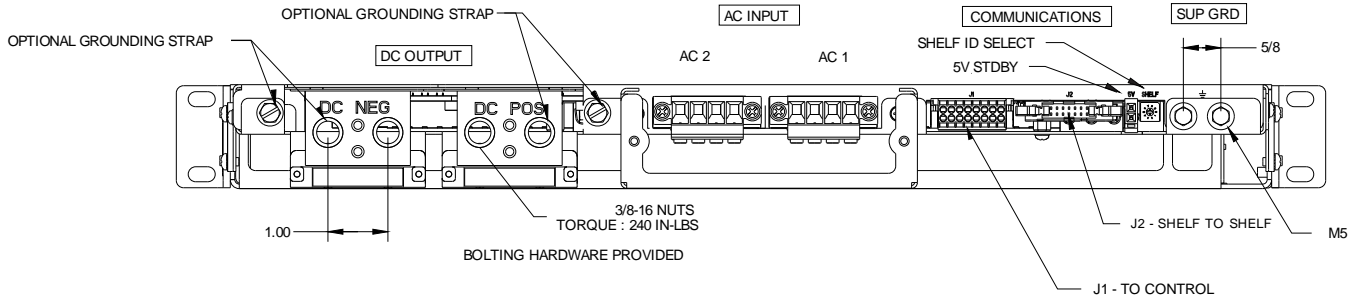

Input

Wire size: 12 (10A) – 10 (15) AWG
 Torque: 7 IN-LBS
 Min strip length: 3/8 inch

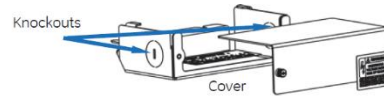
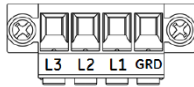

Communications: J1 Connector [dual-row, 3.5mm pitch header]

Connector: Phoenix Contact part # 1787072
 plug-in mate: Phoenix Contact part # 1790548

Pin	Signal	Pin	Signal
1	MOD_PRES_1	9	MOD_PRES_2
2	PFW_1	10	PFW_2
3	SCL_0	11	SDA_0
4	Alert#_0	12	Vprog
5	SCL_1	13	SDA_1
6	Alert#_1	14	Fault_1
7	Fault_2	15	+5V
8	Logic_GRD	16	Remote ON/OFF

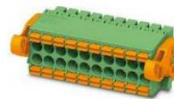

With Lock & Release levers for locking and releasing

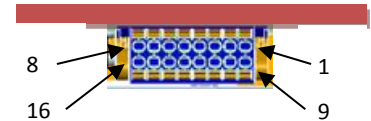

single wire jumper – between Remote ON/OFF and Logic_GRD

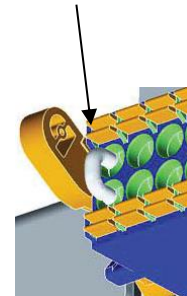

Operation without I2C communications: A Jumper shorting Remote ON/OFF- (turn ON) to Logic_GRD is inserted into the J1 signal connector by the factory.

Remove this jumper prior to inserting the J1 connector.

Compact Power Line Shelves
Dual I²C shelves for the GP100 rectifier
 Model: J2014001L601

Communication Signals

Shelf-to shelf J2 Connector [dual row, header]

This connector is used to interconnect communications lines between shelves. Up to eight shelves (16 power supplies) can be inter connected in this fashion with individual addressing assignments.

Connector: header: TE 5102159-2
 latch: TE 102320-1

plug-in mate: ribbon cable individual wires

header: TE 1658621-2 TE 102387-2

retainer: TE 499252-9

pin: TE 6-87756-8

Pin	Signal	Pin	Signal
1	SCL_0	8	SDA_1
2	SDA_0	9	Isolation n/c
3	Alert#_0	10	Isolation n/c
4	5VA	11	8V_INT
5	Logic_GRD	12	Ishare
6	Alert#_1	13	spare
7	SCL_1	14	spare

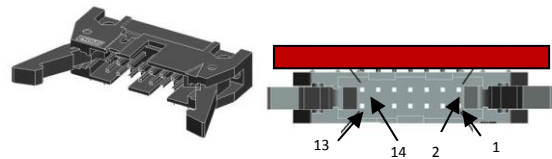

An interconnect ribbon cable is available for two shelves stacked on top of each other (see parts list for information).

Notes: (For all other signals refer to the rectifier data sheet)

8V_INT-x, and Ishare-x are referenced to power output Vout(-). All other signals are referenced to Logic_GRD.

Unit ID:

For communications, unit_ID is configured by a resistor at the power supply connector of each slot.

Unit_ID	Voltage level	Rs (± 0.1%)
Invalid	3.30	
6	1.35	7.15k
7	1.02	4.99k

Compact Power Line Shelves
Dual I²C shelves for the GP100 rectifier
 Model: J2014001L601

Rack_ID:

Up to 8 combinations are selectable. The Rack_ID resistor network is referenced to Logic_GRD.

A voltage divider between 5V_{DC} and Logic_GRD configures Rack_ID. A switch between each R_S value changes the Rack_ID level according to the table below.

DRD RIGHT ANGLE
PC MOUNT

Part (or equivalent): TE 1825008-2
 Comcode: 408524788
 - with ground terminal

viewed
from bottom of switch

Rack_ID	Voltage level
1	3.30
2	1.08
3	1.91
4	0.59
5	1.67
6	0.85
7	1.44
8	2.87

Resistor tolerance: ± 0.1%

- **Address detection:** The **Slot_ID pin** must be shorted to **Vout(-)** on each rectifier connector in order to deliver output power. This connection provides a second interlock feature.
- **Pull-up resistors:** 10kΩ pull-up resistors are provided between each signal pin; Clock, Data, Fault, PFW, and +3.3V³ for customers who would desire these components within the shelf.
- **Always ON:** The shelf is shipped from the factory with a jumper between ENABLE and Logic_GRD of the J1 signal connector. This assures that the rectifiers would turn ON with output power Enabled if the shelf is not integrated with an external cable set by the customer.

³ The 3.3V is generated by two diode drops below +5V.

Compact Power Line Shelves
Dual I²C shelves for the GP100 rectifier
 Model: J2014001L601

- Default Vout, voltage programmability:** A voltage level, Vprog referenced to Logic_GRD, configures the default output voltage setting of the power supply. The graph/schematic below shows the relationship between Vprog and output voltage, and the internally set configuration via the resistor divider, setting the output of the power supplies to 48Vdc, (Vprog = 0.587Vdc). The Vprog signal pins of the two rectifiers are paralleled in the shelf. The Vprog pin is accessible via the J1 connector so the default output voltage setting can be changed by the user. Note that this hardware configured default/adjust setting is valid only as long as the output of the rectifiers were not changed via an I²C command. Firmware commands over-ride the hardware based Vprog level. An AC voltage interruption that is long enough to decay the internal V_{CC} supplied to the DSP controlling the dc-dc converter of the rectifier, resets Vout to its hardware (Vprog) set default level. The rectifier will respond to the Vprog set output voltage instructions until a firmware based output voltage adjustment is received.

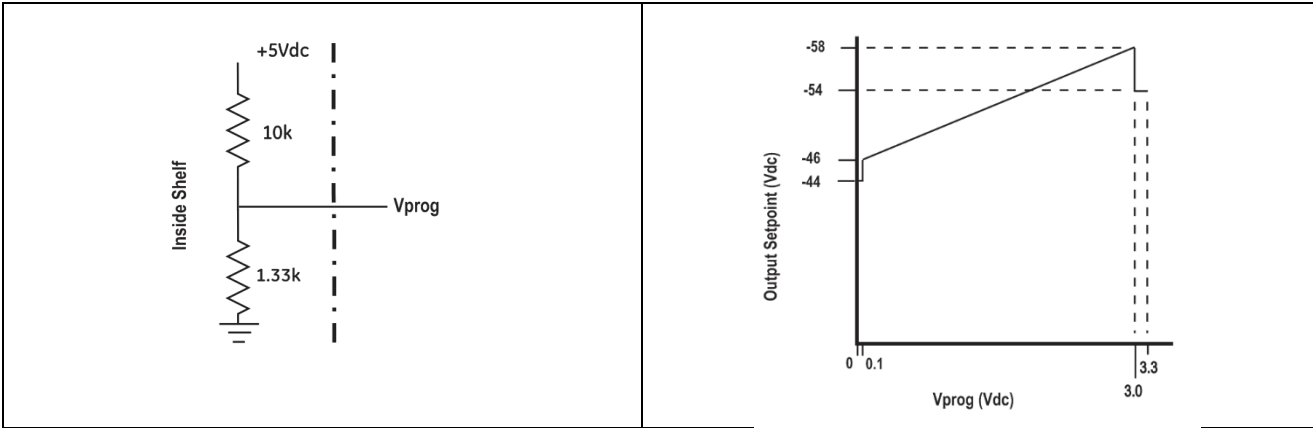

- 8V_INT:** This signal pin is interconnected between the two rectifier slots. It is also available on the J2 shelf-to-shelf connector for reverse bias capability among shelves. The reference for this signal is Vout(-).
- Ishare:** This signal pin is interconnected between the two rectifier slots. It is also available on the J2 shelf-to-shelf connector for paralleling capability of rectifiers among shelves. The reference for this signal is Vout(-).

Rectifier Installation

Caution: The rectifier latch is not a carrying handle
 To release the latch, press the dark gray area
 Slide in the rectifier while the latch is in the open position
 As resistance is felt when inserting, slowly close the latch to complete the insertion. When the latch is locked the rectifier is positively engaged in its housing.
 The rectifier can get extracted or inserted while the bus is hot.
 The rectifier is keyed to ensure that it gets inserted into the correct shelf. Do not force mating beyond normally anticipated resistance in order to avoid permanent damage.



Compact Power Line Shelves
Dual I²C shelves for the GP100 rectifier
 Model: J2014001L601

Shelf keying

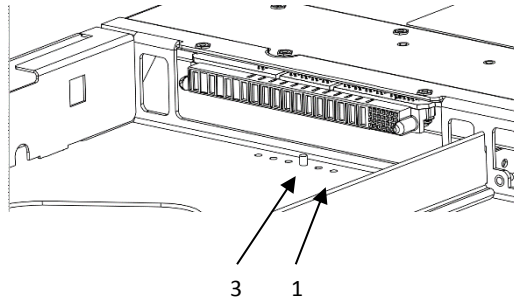

The key is a pin positioned in one of six holes on the bottom of the shelf

			One indicates slot opening					
Communication	Vin	Vout	1	2	3	4	5	6
I2C	3Φ 480	48	1					

Below is a view of the rectifier slot filler configured for slot 1

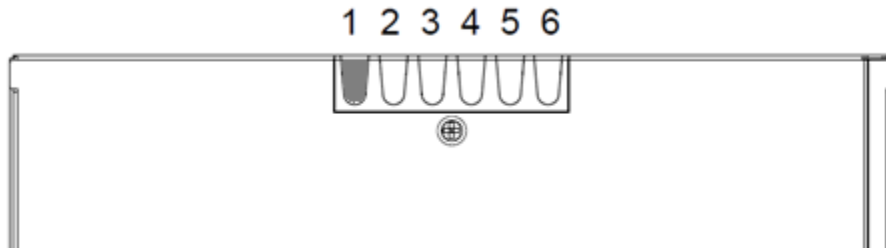

Rectifier Keying - Bottom View

Compact Power Line Shelves
 Dual I²C shelves for the GP100 rectifier
 Model: J2014001L601

Package Outline

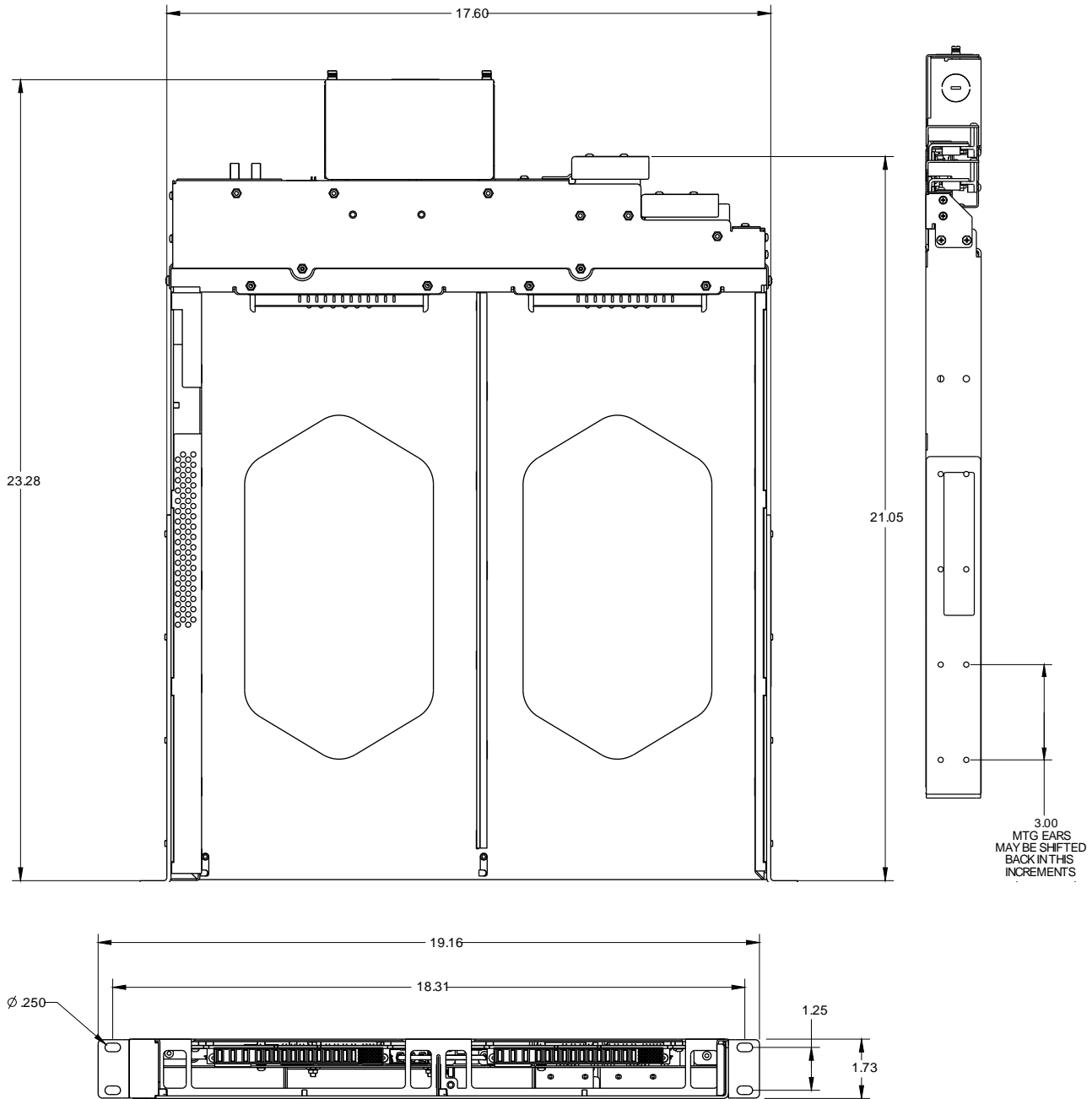





Compact Power Line Shelves
Dual I²C shelves for the GP100 rectifier
 Model: J2014001L601

Ordering Information

Part Number	Description	Comcode
<i>Shelves</i>		
J2014001L601	GP100, 3Φ-480, dual, redundant, I ² C shelf configured for 48Vdc output, configured for slot 1, hardware and shelf interconnect included	150041782
J2014001L601A	GP100, 3Φ-480, dual, redundant, I ² C shelf configured for 54Vdc output, configured for slot 1, hardware and shelf interconnect included	150049293
<i>Accessories</i>		
	GP100 Slot Filler	150045141
	Inter-shelf cable set for connecting J2 signals between shelves	CC848848952
	1u_CPL shelf Interface Board	150045498
	Cable interface from J1 of the shelf to the CPL Interface Board	850050921
	USB Isolated Interface Adapter	150036482

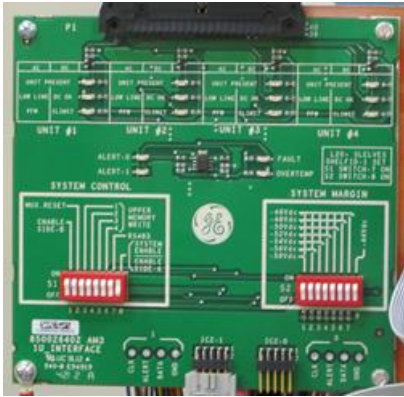
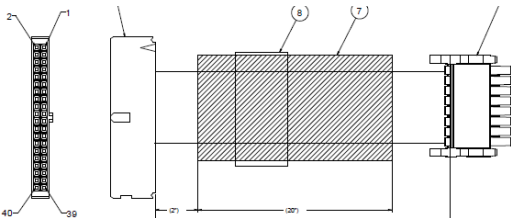
Compact Power Line Shelves
 Dual I²C shelves for the GP100 rectifier
 Model: J2014001L601

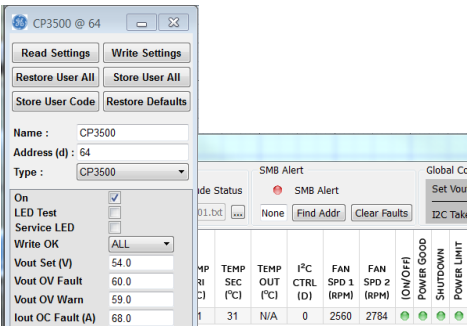
Accessories

Item	Description	Part number
	<p>1u_CP3500_shelf_interface board. This debug tool can be used to evaluate the performance of a set of rectifiers inserted into this shelf. The board provides terminations to two independent Isolated Adaptors that can be connected to either of the two i2c lines. Additionally, connection points are provided for interfacing to the four signals of each i2c line for monitoring the signals. The input interface is a standard IEC 320 C20 type socket. Outputs are connected via standard 0.25 fast-ons.</p>	<p>150045498</p>
	<p>Interface cable between the J1 signal connector of the shelf and the 40 pin mating connector of the interface board above.</p>	<p>850050921</p>
	<p>Isolated Interface Adapter Kit – interface between a USB port and the I²C connector on the rectifier interface board. Includes a cable set to the PC and to the 1u_CP3500_interface board above.</p>	<p>150036482</p>
	<p>The site below downloads the GE Digital Power Insight™ software tools, including the pro_GUI. When the download is complete, icons for the various utilities will appear on the desktop. Click on pro_GUI.exe to start the program after the download is complete.</p> <p>http://www.geindustrial.com/products/embedded-power</p> <p>Graphical User Interface Manual; The GUI download created a directory  In that directory start the DPI_manual.pdf file.</p>	<p>Free download</p>

The GE Digital Power Insight™ software tool exercises the various commands and functions available via the PMBus™ interface of the power supply.

Additionally, two independent GUIs, representing two independent ‘system controllers’, can be connected to the two independent, multiplexed i²C lines in order to demonstrate the redundant communications features of the platform. The GUI displays and controls which i²C line is in control. The GUIs can also be set up such that control is shifted automatically from one controller to the other, executed at a pre-set time interval.

Another useful feature of the GUI is the automated polling feature that records all time stamped state changes automatically. The power system can be monitored for an extended period of time and if any operational state changed it will be recorded for further analysis.

Compact Power Line Shelves

Dual I²C shelves for the GP100 rectifier

Model: J2014001L601

Safety

Product Labeling

Follow all warnings and instructions marked on the product. Some of the safety symbols used with the CP3500 rectifier and this shelf may include the following. They may also be accompanied by instructions:

Mounting and Installation

- This product shall be installed in compliance with mounting requirements for the ultimate application.
- This product must be installed, serviced, and operated only by skilled and qualified personnel who have the necessary knowledge and practical experience with electrical equipment and who understand the hazards that can arise when working on this type of equipment. This product is intended for use in a Restricted Access Location.
- This equipment is to be used in controlled environments (an area where the humidity is maintained at levels that cannot cause condensation on the equipment, the contaminating dust is controlled, and the steady-state ambient temperature is within the range specified).
- This equipment has been evaluated for use in a continuous ambient temperature of up to 55°C and the application environment should not exceed 55°C.
- The CE mark if provided on the product is applied to show conformance to the requirements outlined in the European Union's Low Voltage Directive {2006/95/EC} and EMC Directive {2004/108/EC}.
- This shelf has been evaluated for hot swapping.
- A separate protective Earthing terminal is provided at the rear of the shelf
 - the building installation shall provide a means for connection to protective earth; and
 - the equipment is to be connected to that means; and
 - a SERVICE PERSON shall check whether or not the socket-outlet from which the equipment is to be powered provides a connection to the building protective earth. If not, the SERVICE PERSON shall arrange for the installation of a PROTECTIVE EARTHING CONDUCTOR from the separate protective Earthing terminal to the protective earth wire in the building.

Compact Power Line Shelves

Dual I²C shelves for the GP100 rectifier

Model: J2014001L601

Output Connections

- All field wiring should comply with the U.S. National Electrical Code (NEC) and/or applicable local codes/standards.
- Routing of the DC output cables should guarantee that cables are not in contact with sources of heat and surfaces that may damage the cable insulation.
- The DC output is not provided with a fuse or circuit breaker suitable for branch circuit protection. Therefore, the power shelf should be mounted in the same rack or cabinet as the equipment being powered. Use interconnecting power cables suitable for the application and sized to carry the rated output current. The interconnecting cables should be capable of carrying the overload current and short circuit current without damage or risk of fire.
- The output for the system is SELV and has available power greater than 240VA.
- Insulation on output field-wired conductors should be rated no less than 90°C. Wiring internal to enclosed equipment cabinets should be rated at 105°C (minimum). The provided DC output cords (red and black wires) are rated for 105°C.
- Before opening the insulating cover to gain access to load and ground connections, ensure all power supplies are disconnected from the AC MAINS.

AC Input Connections

- This shelf is configured with primary internal wiring and Molex connectors, rated for internal factory wiring only. The Molex connector is not UL Recognized for direct connection to the AC mains. The internal wiring is not UL recognized to be directly accessible by a user. Consideration should be taken on the end product's Listing to comply with NEC requirement for AC mains installations.
- AC branch circuits to this equipment must be protected with fuses or circuit breakers sized as required by the U.S. National Electric Code (NEC) and/or local codes. Up to four AC mains power cords are required to power the shelf (one for each rectifier). Each power cord should be connected to a separate AC mains branch circuit with an overcurrent protector rated at no more than 30A.
- The power supply mains inlet may be used as the means to provide AC protective earthing.
- An accessible AC disconnect/protection device to remove AC power from the equipment in the event of an emergency must be provided. An accessible socket-outlet/receptacle installed near the equipment is also acceptable as a disconnect.
- The equipment is powered by multiple AC inputs (one per rectifier). Disconnect all AC sources of power before servicing.
- These units are to be used with TN-S power systems only.

Safety Symbols and Guidelines

Read and understand all instructions before attempting any installation of this product. When installing, operating, or maintaining the J85480S1 Power System, basic safety precautions should always be followed to reduce the risk of fire, electric shock, and injury to persons. Such precautions include the following:



This symbol identifies the need to refer to the equipment instructions for important information.



This symbol identifies the presence of hazardous AC or DC voltages or hazardous energy levels. In the context of this product

- The DC output cables contain electrical energy levels capable of causing heating and arcing if shorted to metal objects. Make connections with the power disconnected.
- Hazardous AC voltage and DC electrical energy is contained within the enclosure of the power shelf. No user or field serviceable parts inside.



This symbol is used to identify safety earth ground connection points within the equipment.

Compact Power Line Shelves
Dual I²C shelves for the GP100 rectifier
Model: J2014001L601

German Safety Guidelines

Installationsanleitung

- Alle Ausgänge des Gerätes erfüllen die Anforderungen für SELV nach IEC/EN60950-1.
- Die Ausgänge des Gerätes liegen über den Limits für Energiegefahr nach IEC/EN60950-1 (>240 VA). Das Gerät ist zum Einbau in ein Montage-Rack bestimmt. Siehe Einbaubestimmungen in der Montageanleitung, um eine Gefährdung des Benutzers während der Installation zu vermeiden.

ACHTUNG:

Hoher Ableitstrom Vor Anschluss an den Versorgungsstromkreis unbedingt Erdungsverbinding herstellen

- Das Produkt ist zum Gebrauch in einer Umgebungstemperatur von max. 55°C bestimmt.
- Die Gerätestecker des Produktes sind dazu bestimmt, eine sichere Erdung des Gerätes herzustellen.
- Das Produkt ist zum Gebrauch in einer Umgebung mit Verschmutzungsgrad 2 nach IEC/EN60950 bestimmt.
- Die Netzteile des Gerätes können während des Betriebes einzeln ausgetauscht werden (Hot Swapping).
- Das Gerät wurde zusammen mit den Anschlussleitungen (ohne Anschlussstecker) geprüft. Die Installation eines Steckers des jeweiligen Landes, sollte nur durch geschultes Service Personal durchgeführt werden. Als alternative könnte eine Vorinstallation des Steckers bereits bei der Herstellung erfolgt sein.

Contact Us

For more information, call us at

USA/Canada:

+1 877 546 3243, or +1 972 244 9288

Asia-Pacific:

+86.021.54279977*808

Europe, Middle-East and Africa:

+49.89.878067-280

www.gecriticalpower.com



GE Critical Power reserves the right to make changes to the product(s) or information contained herein without notice, and no liability is assumed as a result of their use or application. No rights under any patent accompany the sale of any such product(s) or information.