

3A Analog PicoDlynx™: Non-Isolated DC-DC Power Modules

3Vdc –14.4Vdc input; 0.6Vdc to 5.5Vdc output; 3A Output Current



RoHS Compliant

Applications

- Distributed power architectures
- Intermediate bus voltage applications
- Telecommunications equipment
- Servers and storage applications
- Networking equipment
- Industrial equipment

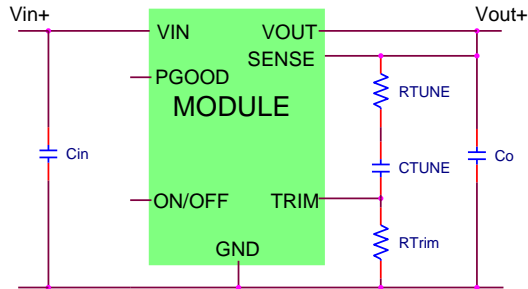

Features

- Compliant to RoHS EU Directive 2002/95/EC (Z versions)
- Compatible in a Pb-free or SnPb reflow environment (Z versions)
- Compliant to IPC-9592 (September 2008), Category 2, Class II
- Use ABB specified module version and process for SMT placement on bottom side of board (-D version only)
- DOSA based
- Wide Input voltage range (3Vdc-14.4Vdc). Ref. to Figure 41 for corresponding output range
- Output voltage programmable from 0.6Vdc to 5.5Vdc via external resistor
- Tunable Loop™ to optimize dynamic output voltage response
- Power Good signal
- Fixed switching frequency
- Output overcurrent protection (non-latching)
- Overtemperature protection
- Remote On/Off
- Ability to sink and source current
- Cost efficient open frame design
- Small size: 12.2 mm x 12.2 mm x 6.25 mm (0.48 in x 0.48 in x 0.246 in)
- Wide operating temperature range [-40°C to 105°C (Ruggedized: -D), 85°C(Regular)]
- UL* 60950-1, 2nd Ed. Recognized, CSA† C22.2 No. 60950-1-07 Certified, and VDE‡ (EN60950-1, 2nd Ed.) Licensed
- ISO** 9001 and ISO 14001 certified manufacturing facilities

Description

The 3A Analog PicoDlynx™ power modules are non-isolated dc-dc converters that can deliver up to 3A of output current. These modules operate over a wide range of input voltage ($V_{IN} = 3Vdc-14.4Vdc$) and provide a precisely regulated output voltage from 0.6Vdc to 5.5Vdc, programmable via an external resistor. Features include remote On/Off, adjustable output voltage, over current and over temperature protection. The Tunable Loop™ feature allows the user to optimize the dynamic response of the converter to match the load with reduced amount of output capacitance leading to savings on cost and PWB area.

* UL is a registered trademark of Underwriters Laboratories, Inc.

† CSA is a registered trademark of Canadian Standards Association.

‡ VDE is a trademark of Verband Deutscher Elektrotechniker e.V.

** ISO is a registered trademark of the International Organization of Standards

3A Analog PicoDLynx™: Non-Isolated DC-DC Power Modules

3Vdc –14.4Vdc input; 0.6Vdc to 5.5Vdc output; 3A Output Current

Absolute Maximum Ratings

Stresses in excess of the absolute maximum ratings can cause permanent damage to the device. These are absolute stress ratings only, functional operation of the device is not implied at these or any other conditions in excess of those given in the operations sections of the data sheet. Exposure to absolute maximum ratings for extended periods can adversely affect the device reliability.

Parameter	Device	Symbol	Min	Max	Unit
Input Voltage Continuous	All	V_{IN}	-0.3	15	Vdc
Operating Ambient Temperature (see Thermal Considerations section)	All	T_A	-40	85	°C
Storage Temperature	All	T_{stg}	-55	125	°C

Electrical Specifications

Unless otherwise indicated, specifications apply over all operating input voltage, resistive load, and temperature conditions.

Parameter	Device	Symbol	Min	Typ	Max	Unit
Operating Input Voltage	All	V_{IN}	3	—	14.4	Vdc
Maximum Input Current ($V_{IN}=3V$ to 14V, $I_O=I_{O,max}$)	All	$I_{IN,max}$			2.4	Adc
Input No Load Current ($V_{IN} = 12.0Vdc$, $I_O = 0$, module enabled)	$V_{O,set} = 0.6 Vdc$	$I_{IN,No load}$		17		mA
	$V_{O,set} = 5Vdc$	$I_{IN,No load}$		38		mA
Input Stand-by Current ($V_{IN} = 12.0Vdc$, module disabled)	All	$I_{IN,stand-by}$		0.8		mA
Inrush Transient	All	I^2t			1	A ² s
Input Reflected Ripple Current, peak-to-peak (5Hz to 20MHz, 1 μ H source impedance; $V_{IN} = 0$ to 14V, $I_O = I_{O,max}$; See Test Configurations)	All			15		mAp-p
Input Ripple Rejection (120Hz)	All			-60		dB

3A Analog PicoDLynx™: Non-Isolated DC-DC Power Modules

3Vdc –14.4Vdc input; 0.6Vdc to 5.5Vdc output; 3A Output Current

Electrical Specifications (continued)

Parameter	Device	Symbol	Min	Typ	Max	Unit
Output Voltage Set-point (with 0.1% tolerance for external resistor used to set output voltage)	All	$V_{O, set}$	-1.0		+1.0	% $V_{O, set}$
Output Voltage (Over all operating input voltage, resistive load, and temperature conditions until end of life)	All	$V_{O, set}$	-3.0	—	+3.0	% $V_{O, set}$
Adjustment Range (selected by an external resistor) (Some output voltages may not be possible depending on the input voltage – see Feature Descriptions Section)	All	V_o	0.6		5.5	Vdc
Remote Sense Range	All				0.5	Vdc
Output Regulation (for $V_o \geq 2.5$ Vdc)						
Line ($V_{IN}=V_{IN, min}$ to $V_{IN, max}$)	All			—	+0.4	% $V_{O, set}$
Load ($I_o=I_{o, min}$ to $I_{o, max}$)	All			—	10	mV
Output Regulation (for $V_o < 2.5$ Vdc)						
Line ($V_{IN}=V_{IN, min}$ to $V_{IN, max}$)	All			—	5	mV
Load ($I_o=I_{o, min}$ to $I_{o, max}$)	All			—	10	mV
Temperature ($T_{ref}=T_{A, min}$ to $T_{A, max}$)	All			—	0.4	% $V_{O, set}$
Output Ripple and Noise on nominal output ($V_{IN}=V_{IN, nom}$ and $I_o=I_{o, min}$ to $I_{o, max}$ $C_o = 0.1\mu F // 22\mu F$ ceramic capacitors)						
Peak-to-Peak (5Hz to 20MHz bandwidth)	All		—	50	100	mV _{pk-pk}
RMS (5Hz to 20MHz bandwidth)	All			20	38	mV _{rms}
External Capacitance ¹						
Without the Tunable Loop™						
ESR ≥ 1 m Ω	All	$C_{o, max}$	10	—	22	μF
With the Tunable Loop™						
ESR ≥ 0.15 m Ω	All	$C_{o, max}$	10	—	1000	μF
ESR ≥ 10 m Ω	All	$C_{o, max}$	10	—	3000	μF
Output Current (in either sink or source mode)	All	I_o	0		3	A _{dc}
Output Current Limit Inception (Hiccup Mode) (current limit does not operate in sink mode)	All	$I_{o, lim}$		200		% $I_{o, max}$
Output Short-Circuit Current ($V_o \leq 250$ mV) (Hiccup Mode)	All	$I_{o, s/c}$		0.5		A _{rms}
Efficiency	$V_{O, set} = 0.6$ Vdc (8Vin)	η		75		%
$V_{IN} = 12$ Vdc, $T_A = 25^\circ C$	$V_{O, set} = 1.2$ Vdc	η		82.8		%
$I_o = I_{o, max}$, $V_o = V_{O, set}$	$V_{O, set} = 1.8$ Vdc	η		88.2		%
	$V_{O, set} = 2.5$ Vdc	η		89.9		%
	$V_{O, set} = 3.3$ Vdc	η		91.6		%
	$V_{O, set} = 5.0$ Vdc	η		93.9		%
Switching Frequency	All	f_{sw}	—	600	—	kHz

¹ External capacitors may require using the new Tunable Loop™ feature to ensure that the module is stable as well as getting the best transient response. See the Tunable Loop™ section for details.

3A Analog PicoDLynx™: Non-Isolated DC-DC Power Modules

3Vdc –14.4Vdc input; 0.6Vdc to 5.5Vdc output; 3A Output Current

General Specifications

Parameter	Device	Min	Typ	Max	Unit
Calculated MTBF ($I_o=0.8I_{o,max}$, $T_A=40^\circ\text{C}$) Telecordia Issue 2 Method 1 Case 3	All		19,508,839		Hours
Weight		—	0.89 (0.031)	—	g (oz.)

Feature Specifications

Unless otherwise indicated, specifications apply over all operating input voltage, resistive load, and temperature conditions. See Feature Descriptions for additional information.

Parameter	Device	Symbol	Min	Typ	Max	Unit
On/Off Signal Interface ($V_{IN}=V_{IN,min}$ to $V_{IN,max}$; open collector or equivalent, Signal referenced to GND) Device is with suffix "4" – Positive Logic (See Ordering Information)						
Logic High (Module ON)						
Input High Current	All	I_{IH}	—	—	1	mA
Input High Voltage	All	V_{IH}	3.0	—	$V_{IN,max}$	V
Logic Low (Module OFF)						
Input Low Current	All	I_{IL}	—	—	10	μA
Input Low Voltage	All	V_{IL}	-0.2	—	0.3	V
Device Code with no suffix – Negative Logic (See Ordering Information) (On/OFF pin is open collector/drain logic input with external pull-up resistor; signal referenced to GND)						
Logic High (Module OFF)						
Input High Current	All	I_{IH}	—	—	1	mA
Input High Voltage	All	V_{IH}	3.0	—	$V_{IN,max}$	Vdc
Logic Low (Module ON)						
Input low Current	All	I_{IL}	—	—	10	μA
Input Low Voltage	All	V_{IL}	-0.2	—	0.4	Vdc
Turn-On Delay and Rise Times						
($V_{IN}=V_{IN,nom}$, $I_o=I_{o,max}$, V_o to within $\pm 1\%$ of steady state)						
Case 1: On/Off input is enabled and then input power is applied (delay from instant at which $V_{IN} = V_{IN,min}$ until $V_o =$ 10% of $V_{o,set}$)	All	Tdelay	—	4	—	msec
Case 2: Input power is applied for at least one second and then the On/Off input is enabled (delay from instant at which Von/Off is enabled until $V_o =$ 10% of $V_{o,set}$)	All	Tdelay	—	4.8	—	msec
Output voltage Rise time (time for V_o to rise from 10% of $V_{o,set}$ to 90% of $V_{o,set}$)	All	Trise	—	2.8	—	msec
Output voltage overshoot ($T_A = 25^\circ\text{C}$ $V_{IN} = V_{IN,min}$ to $V_{IN,max}$, $I_o = I_{o,min}$ to $I_{o,max}$) With or without maximum external capacitance					3.0	% $V_{o,set}$
Over Temperature Protection (See Thermal Considerations section)	All	T_{ref}		135		$^\circ\text{C}$

3A Analog PicoDLynx™: Non-Isolated DC-DC Power Modules
 3Vdc –14.4Vdc input; 0.6Vdc to 5.5Vdc output; 3A Output Current

Feature Specifications (cont.)

Parameter	Device	Symbol	Min	Typ	Max	Units
Input Undervoltage Lockout						
Turn-on Threshold	All				3.0	Vdc
Turn-off Threshold	All			2.69		Vdc
Hysteresis	All			0.2		Vdc
PGOOD (Power Good)						
Signal Interface Open Drain, $V_{supply} \leq 5VDC$						
Overvoltage threshold for PGOOD				112.5		% $V_{O,set}$
Undervoltage threshold for PGOOD				87.5		% $V_{O,set}$
Pulldown resistance of PGOOD pin	All			30		Ω
Sink current capability into PGOOD pin	All				5	mA

3A Analog PicoDlynx™: Non-Isolated DC-DC Power Modules

3Vdc –14.4Vdc input; 0.6Vdc to 5.5Vdc output; 3A Output Current

Characteristic Curves

The following figures provide typical characteristics for the 3A Analog PicoDlynx™ at 0.6Vo and 25°C.

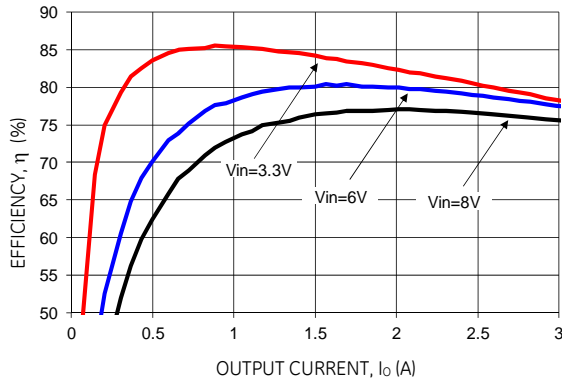

Figure 1. Converter Efficiency versus Output Current.

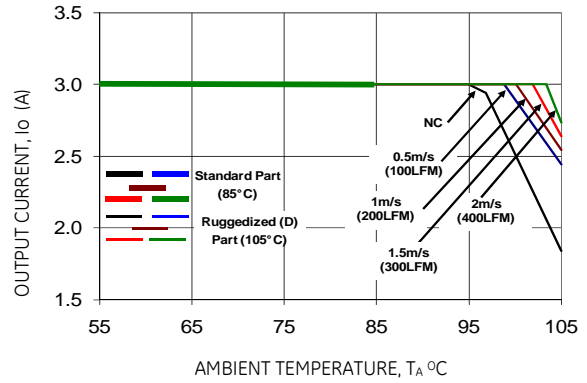

Figure 2. Derating Output Current versus Ambient Temperature and Airflow.

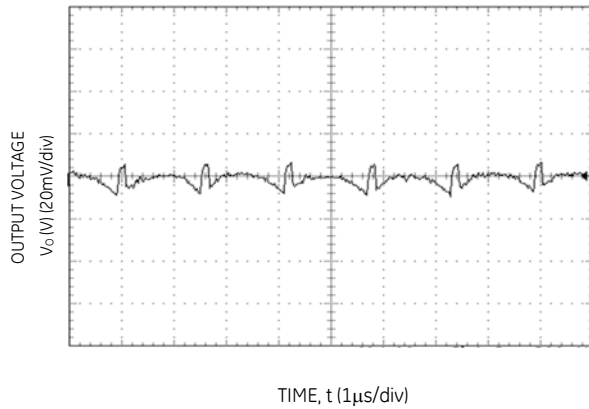

Figure 3. Typical output ripple and noise (Co=10µF ceramic, VIN = 8V, Io = Io,max.).

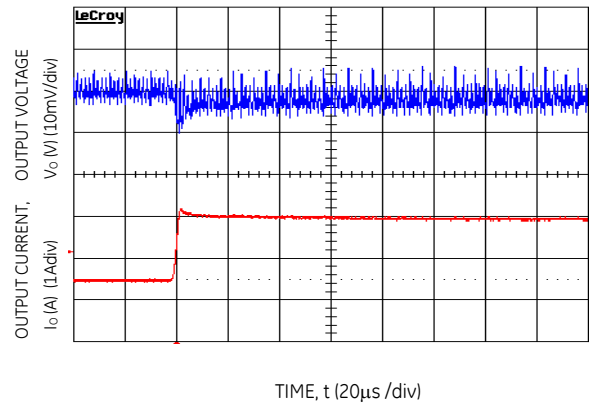

Figure 4. Transient Response to Dynamic Load Change from 50% to 100% at 8Vin, Cout-1x47uF+2x330uF, CTune-27nF, RTune-178

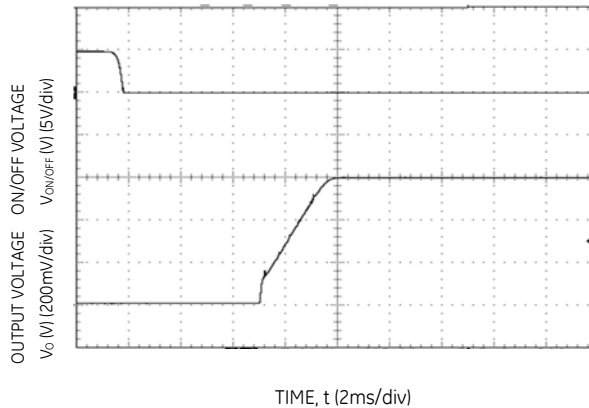

Figure 5. Typical Start-up Using On/Off Voltage (Io = Io,max.).

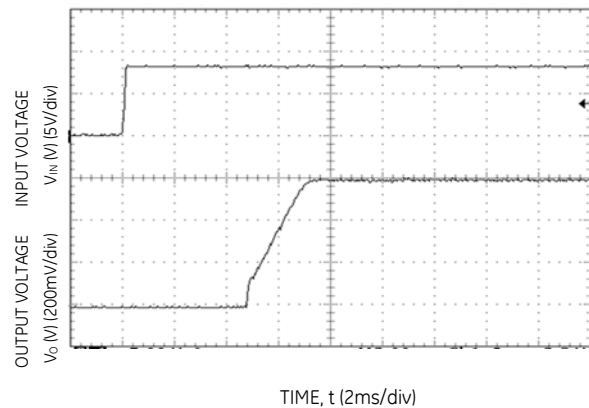

Figure 6. Typical Start-up Using Input Voltage (VIN = 8V, Io = Io,max.).

3A Analog PicoDLynx™: Non-Isolated DC-DC Power Modules

3Vdc –14.4Vdc input; 0.6Vdc to 5.5Vdc output; 3A Output Current

Characteristic Curves

The following figures provide typical characteristics for the 3A Analog PicoDLynx™ at 1.2Vo and 25°C.

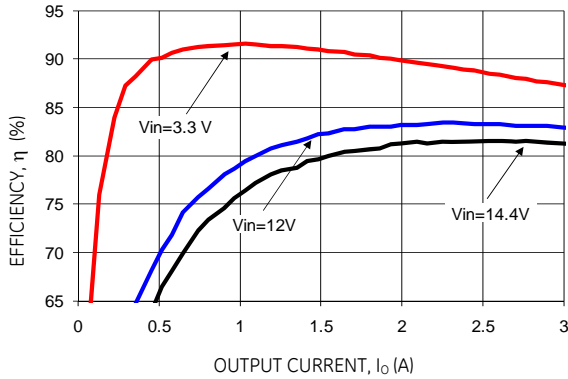

Figure 7. Converter Efficiency versus Output Current.

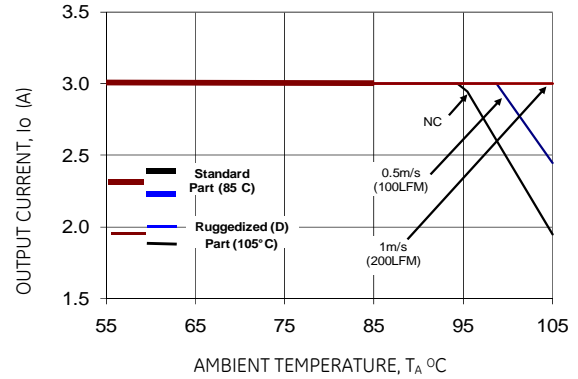

Figure 8. Derating Output Current versus Ambient Temperature and Airflow.

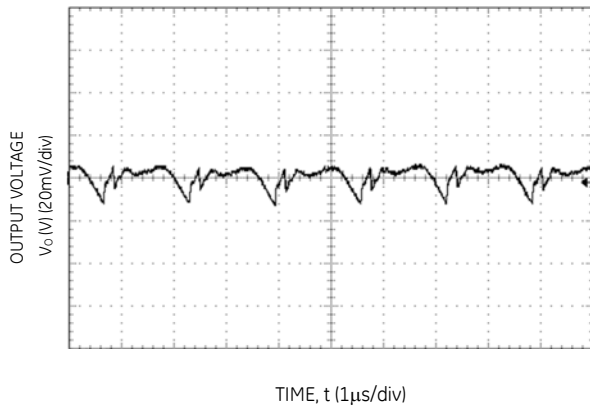

Figure 9. Typical output ripple and noise (Co=10µF ceramic, VIN = 12V, Io = Io,max.).

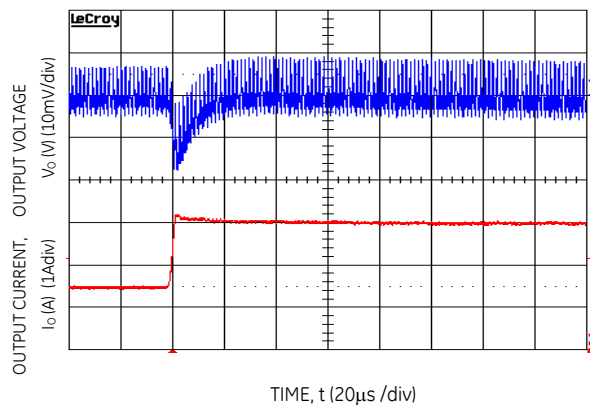

Figure 10. Transient Response to Dynamic Load Change from 50% to 100% at 12Vin, Cout-1x47uF+1x330uF, CTune-10nF & RTune-261

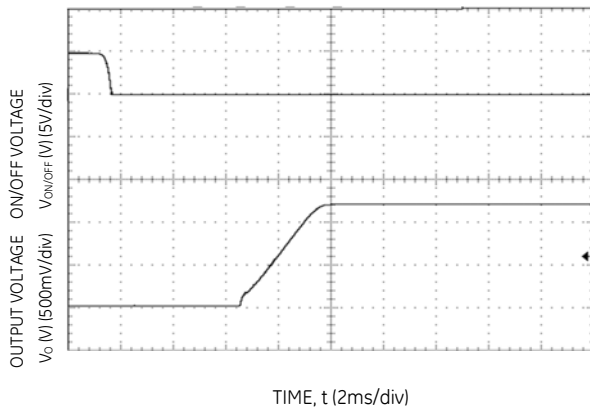

Figure 11. Typical Start-up Using On/Off Voltage (Io = Io,max.).

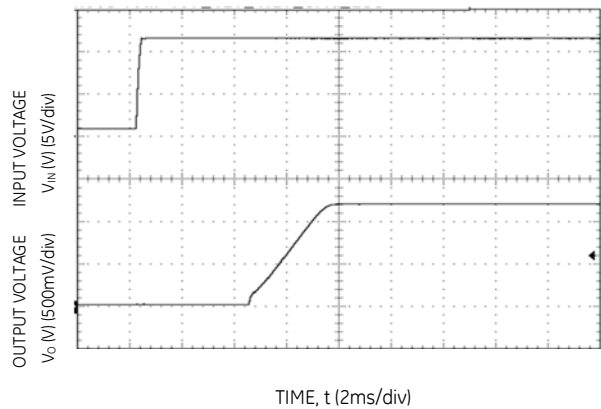

Figure 12. Typical Start-up Using Input Voltage (VIN = 12V, Io = Io,max.).

3A Analog PicoDLynx™: Non-Isolated DC-DC Power Modules

3Vdc –14.4Vdc input; 0.6Vdc to 5.5Vdc output; 3A Output Current

Characteristic Curves

The following figures provide typical characteristics for the 3A Analog PicoDLynx™ at 1.8V_o and 25°C.

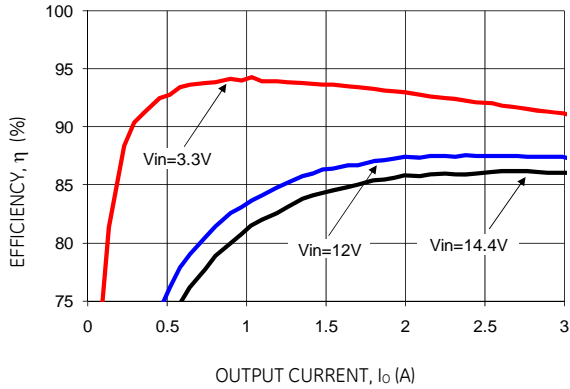

Figure 13. Converter Efficiency versus Output Current.

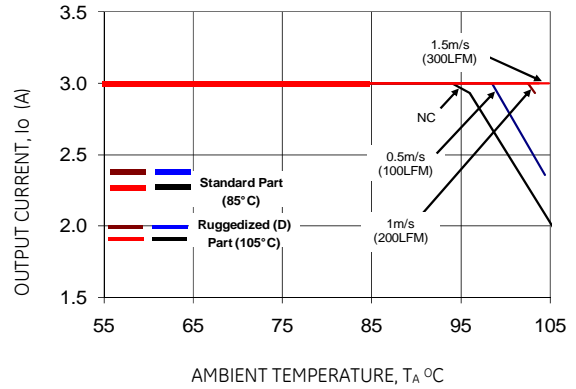

Figure 14. Derating Output Current versus Ambient Temperature and Airflow.

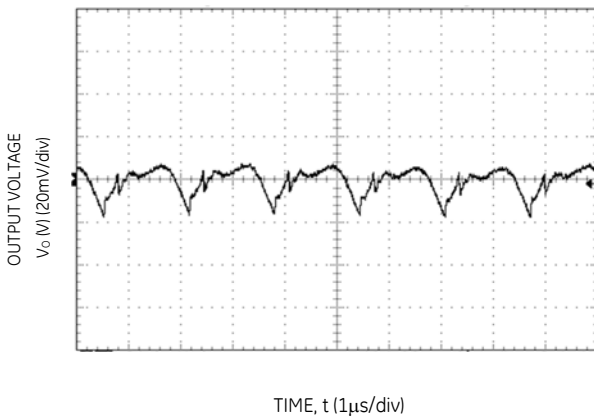

Figure 15. Typical output ripple and noise (C_o=10µF ceramic, V_{IN} = 12V, I_o = I_{o,max}).

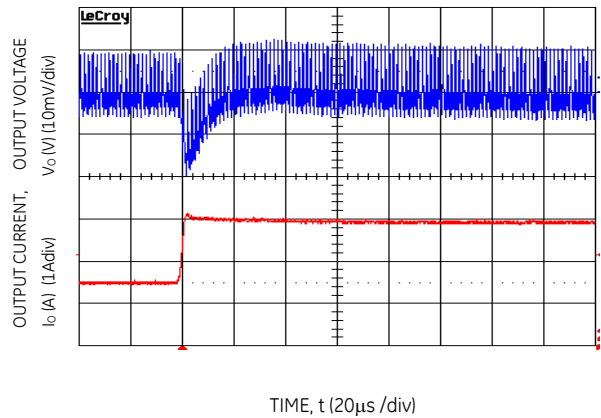

Figure 16. Transient Response to Dynamic Load Change from 50% to 100% at 12V_{in}, C_{out}-1x47µF+1x330µF, C_{Tune}-10nF & R_{Tune}-261

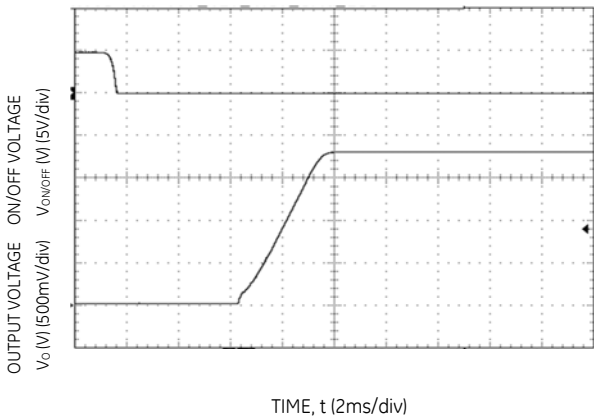

Figure 17. Typical Start-up Using On/Off Voltage (I_o = I_{o,max}).

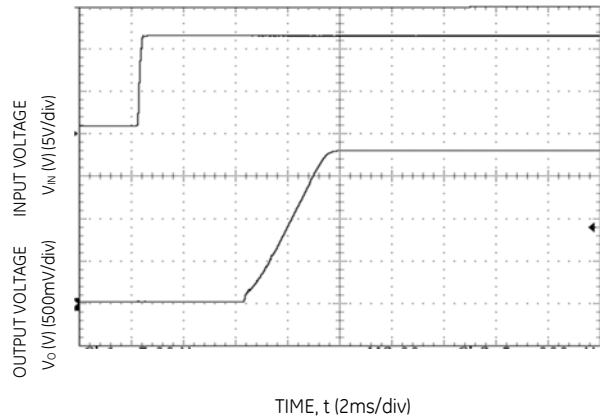

Figure 18. Typical Start-up Using Input Voltage (V_{IN} = 12V, I_o = I_{o,max}).

3A Analog PicoDLynx™: Non-Isolated DC-DC Power Modules

3Vdc –14.4Vdc input; 0.6Vdc to 5.5Vdc output; 3A Output Current

Characteristic Curves

The following figures provide typical characteristics for the 3A Analog PicoDLynx™ at 2.5V_o and 25°C.

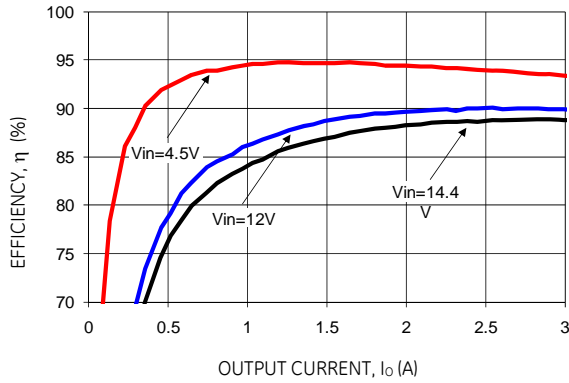

Figure 19. Converter Efficiency versus Output Current.

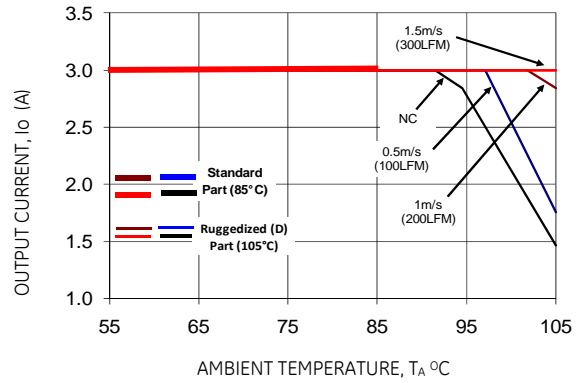

Figure 20. Derating Output Current versus Ambient Temperature and Airflow.

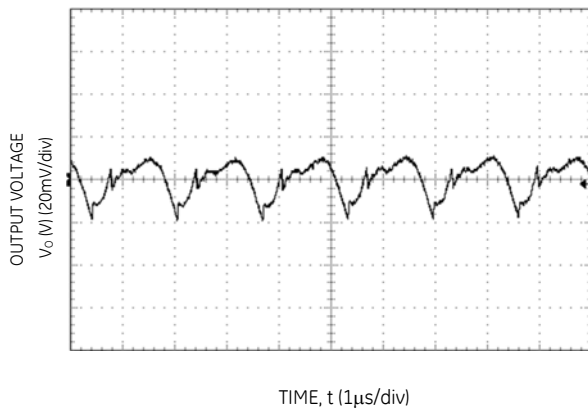

Figure 21. Typical output ripple and noise (C_o=10µF ceramic, V_{IN} = 12V, I_o = I_{o,max}.)

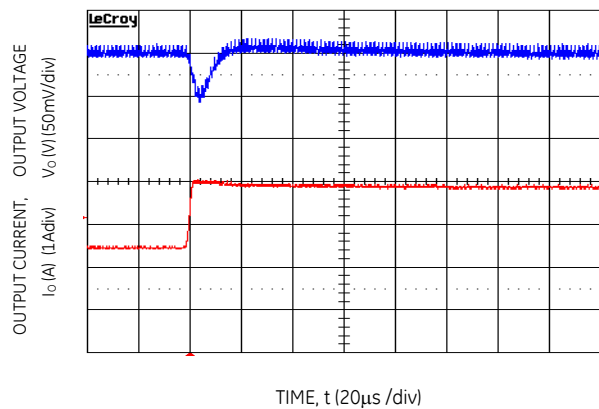

Figure 22. Transient Response to Dynamic Load Change from 50% to 100% at 12V_{in}, C_{out}-2x47µF, C_{Tune}-2700pF & R_{Tune}-261

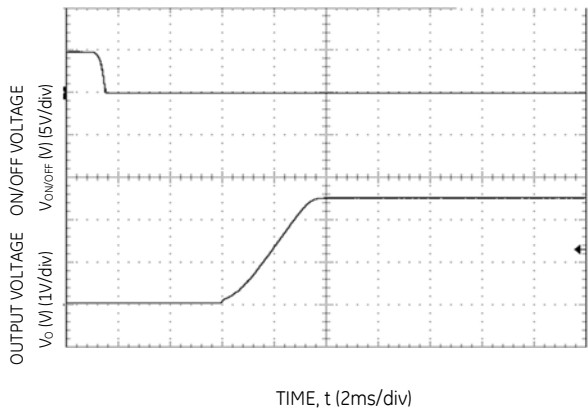

Figure 23. Typical Start-up Using On/Off Voltage (I_o = I_{o,max}.)

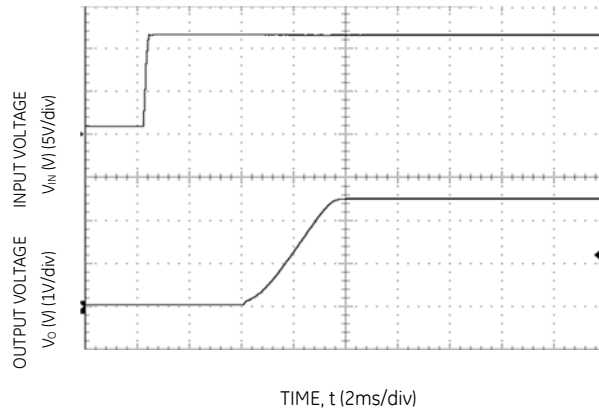

Figure 24. Typical Start-up Using Input Voltage (V_{IN} = 12V, I_o = I_{o,max}.)

3A Analog PicoDLynx™: Non-Isolated DC-DC Power Modules

3Vdc –14.4Vdc input; 0.6Vdc to 5.5Vdc output; 3A Output Current

Characteristic Curves

The following figures provide typical characteristics for the 3A Analog PicoDLynx™ at 3.3Vo and 25°C.

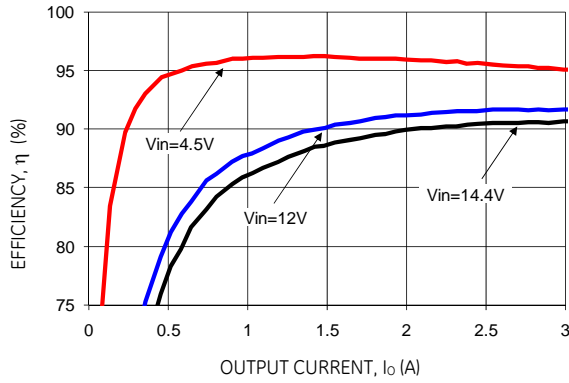

Figure 25. Converter Efficiency versus Output Current.

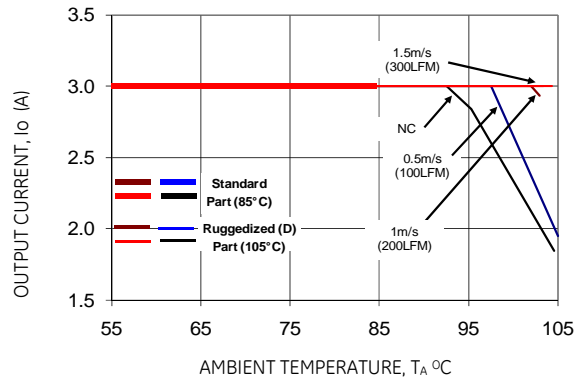

Figure 26. Derating Output Current versus Ambient Temperature and Airflow.

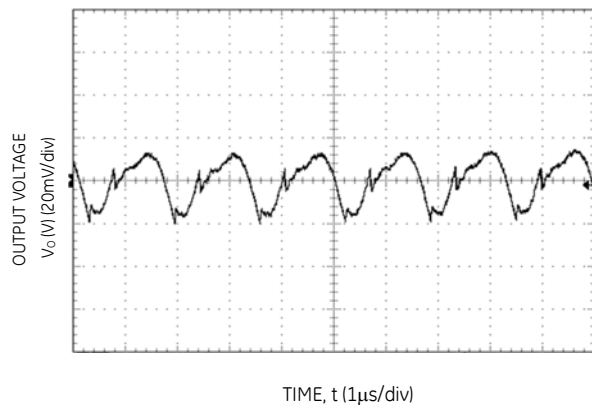

Figure 27. Typical output ripple and noise (Co=10µF ceramic, VIN = 12V, Io = Io,max.).

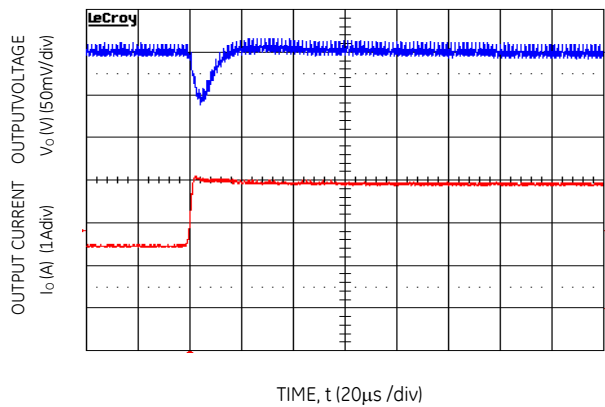

Figure 28. Transient Response to Dynamic Load Change from 50% to 100% at 12Vin, Cout-2x47uF, CTune-2200pF & RTune-261

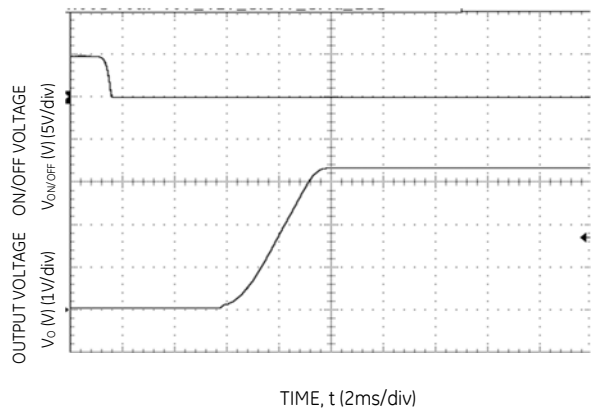

Figure 29. Typical Start-up Using On/Off Voltage (Io = Io,max.).

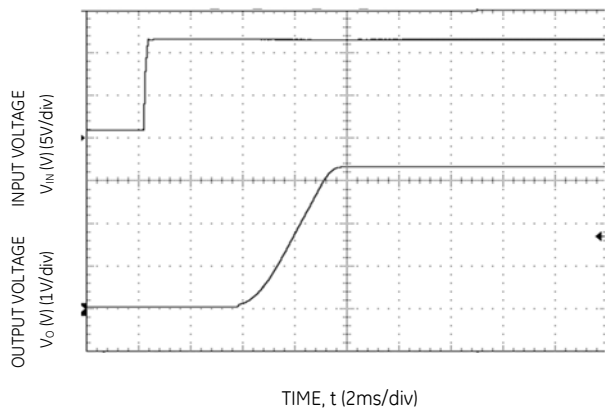

Figure 30. Typical Start-up Using Input Voltage (VIN = 12V, Io = Io,max.).

3A Analog PicoDLynx™: Non-Isolated DC-DC Power Modules

3Vdc –14.4Vdc input; 0.6Vdc to 5.5Vdc output; 3A Output Current

Characteristic Curves

The following figures provide typical characteristics for the 3A Analog PicoDLynx™ at 5Vo and 25°C.

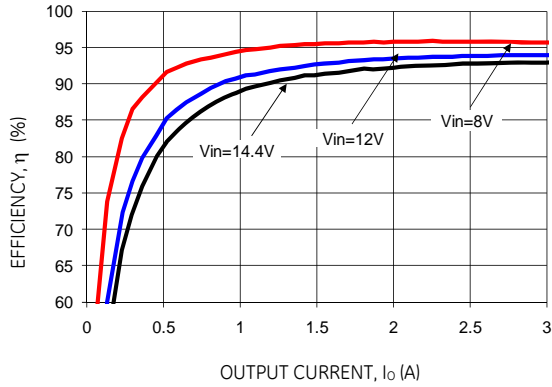

Figure 31. Converter Efficiency versus Output Current.

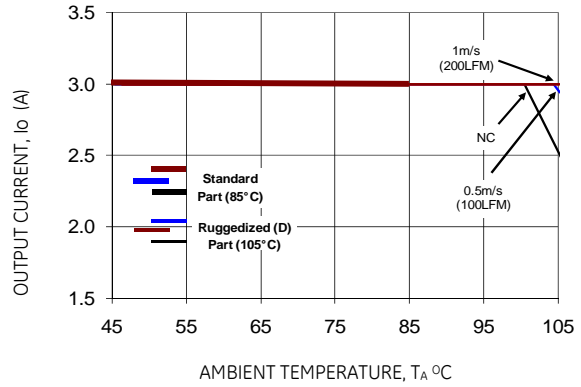

Figure 32. Derating Output Current versus Ambient Temperature and Airflow.

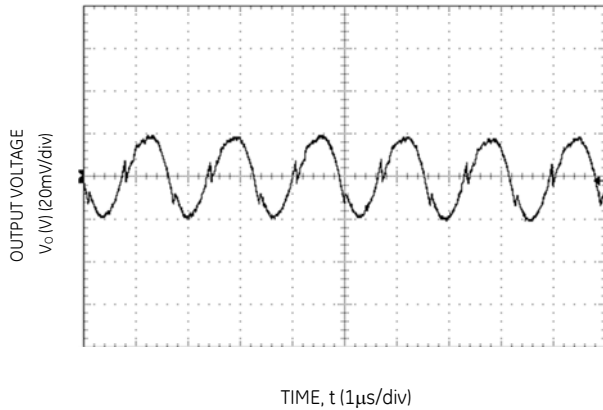

Figure 33. Typical output ripple and noise (Co=10μF ceramic, VIN = 12V, Io = Io,max.).

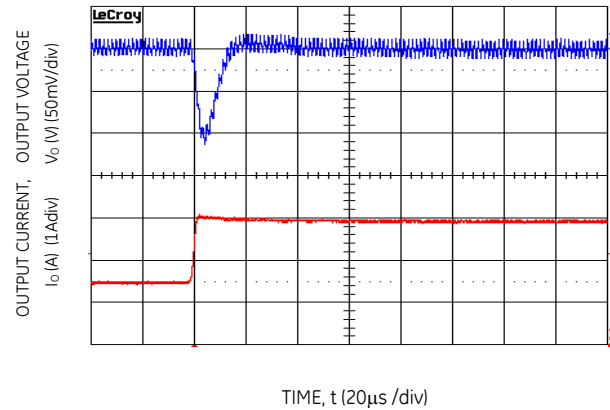

Figure 34. Transient Response to Dynamic Load Change from 50% to 100% at 12Vin, Cout-1x47uF, CTune-820pF & RTune-261

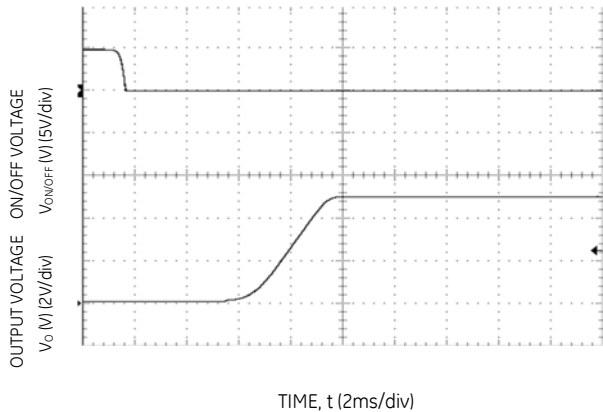

Figure 35. Typical Start-up Using On/Off Voltage (Io = Io,max.).

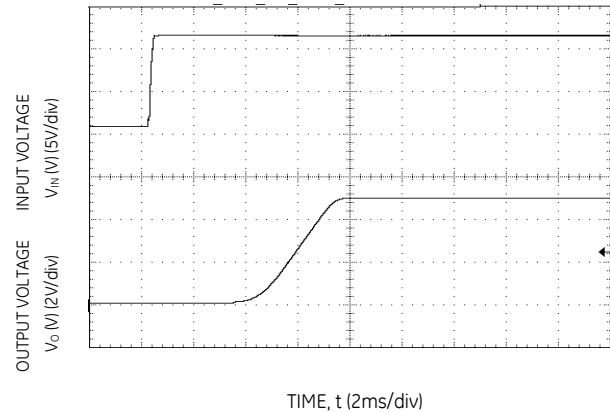

Figure 36. Typical Start-up Using Input Voltage (VIN = 12V, Io = Io,max.).

3A Analog PicoDLynx™: Non-Isolated DC-DC Power Modules

3Vdc –14.4Vdc input; 0.6Vdc to 5.5Vdc output; 3A Output Current

Design Considerations

Input Filtering

The 3A Analog PicoDLynx™ module should be connected to a low ac-impedance source. A highly inductive source can affect the stability of the module. An input capacitance must be placed directly adjacent to the input pin of the module, to minimize input ripple voltage and ensure module stability.

To minimize input voltage ripple, ceramic capacitors are recommended at the input of the module. Figure 37 shows the input ripple voltage for various output voltages at 3A of load current with 1x22µF or 2x22µF ceramic capacitors and an input of 12V.

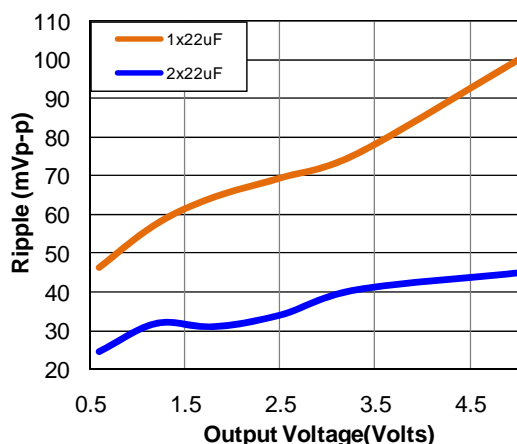

Figure 37. Input ripple voltage for various output voltages with 1x22 µF or 2x22 µF ceramic capacitors at the input (3A load). Input voltage is 12V.

Output Filtering

These modules are designed for low output ripple voltage and will meet the maximum output ripple specification with 0.1 µF ceramic and 10 µF ceramic capacitors at the output of the module. However, additional output filtering may be required by the system designer for a number of reasons. First, there may be a need to further reduce the output ripple and noise of the module. Second, the dynamic response characteristics may need to be customized to a particular load step change.

To reduce the output ripple and improve the dynamic response to a step load change, additional capacitance at the output can be used. Low ESR polymer and ceramic capacitors are recommended to improve the dynamic response of the module. Figure 38 provides output ripple information for different external capacitance values at various Vo and a full load current of 3A. For stable operation of the module, limit the capacitance to less than the maximum output capacitance as specified in the electrical specification table. Optimal performance of the module can be achieved by using the Tunable Loop™ feature described later in this data sheet.

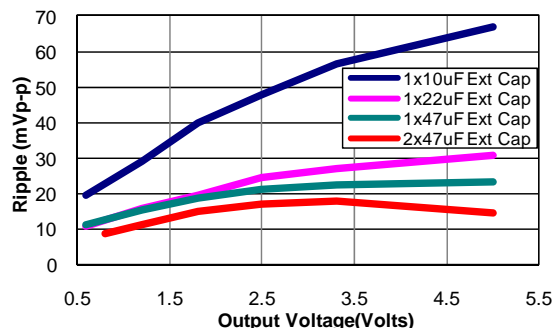

Figure 38. Output ripple voltage for various output voltages with external 1x10µF, 1x22µF, 1x47µF and 2x47µF ceramic capacitors at the output (3A load). Input voltage is 12V.

Safety Considerations

For safety agency approval the power module must be installed in compliance with the spacing and separation requirements of the end-use safety agency standards, i.e., UL 60950-1 2nd, CSA C22.2 No. 60950-1-07, DIN EN 60950-1:2006 + A11 (VDE0805 Teil 1 + A11):2009-11; EN 60950-1:2006 + A11:2009-03.

For the converter output to be considered meeting the requirements of safety extra-low voltage (SELV), the input must meet SELV requirements. The power module has extra-low voltage (ELV) outputs when all inputs are ELV.

The input to these units is to be provided with a fast-acting fuse with a maximum rating of 5A, 125VDC in the positive input lead.

3A Analog PicoDLynx™: Non-Isolated DC-DC Power Modules

3Vdc –14.4Vdc input; 0.6Vdc to 5.5Vdc output; 3A Output Current

Feature Descriptions

Remote On/Off

The 3A Analog PicoDLynx™ power modules feature an On/Off pin for remote On/Off operation. Two On/Off logic options are available. In the Positive Logic On/Off option, (device code suffix “4” – see Ordering Information), the module turns ON during a logic High on the On/Off pin and turns OFF during a logic Low. With the Negative Logic On/Off option, (no device code suffix, see Ordering Information), the module turns OFF during logic High and ON during logic Low. The On/Off signal should be always referenced to ground. For either On/Off logic option, leaving the On/Off pin disconnected will turn the module ON when input voltage is present.

For positive logic modules, the circuit configuration for using the On/Off pin is shown in Figure 39. When the external transistor Q2 is in the OFF state, Q3 is ON, Q4 is OFF and the internal PWM Enable signal is pulled high and the module is ON. When transistor Q2 is turned ON, Q3 is OFF, Q4 turns ON pulling the ENABLE pin low and the module is OFF. A suggested value for R_{pullup} is 20kΩ.

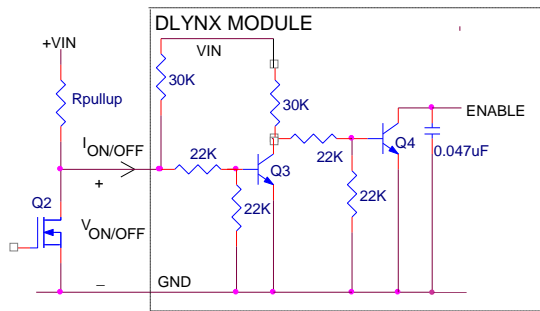

Figure 39. Circuit configuration for using positive On/Off logic.

For negative logic On/Off modules, the circuit configuration is shown in Fig. 40. The On/Off pin should be pulled high with an external pull-up resistor (suggested value for the 3V to 14.4V input range is 20Kohms). When transistor Q1 is in the OFF state, the On/Off pin is pulled high, internal transistor Q4 is turned ON and the module is OFF. To turn the module ON, Q1 is turned ON pulling the On/Off pin low, turning transistor Q4 OFF resulting in the PWM Enable pin going high and the module turning ON.

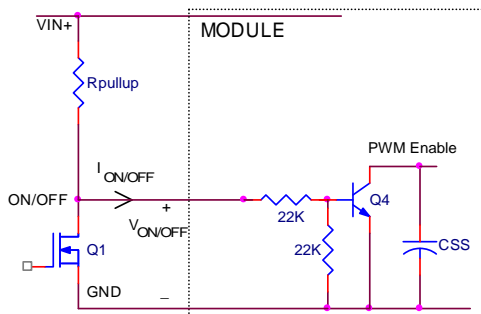

Figure 40. Circuit configuration for using negative On/Off logic.

Monotonic Start-up and Shutdown

The module has monotonic start-up and shutdown behavior for any combination of rated input voltage, output current and operating temperature range.

Startup into Pre-biased Output

The modules can start into a prebiased output as long as the prebias voltage is 0.5V less than the set output voltage.

Output Voltage Programming

The output voltage of the module is programmable to any voltage from 0.6dc to 5.5Vdc by connecting a resistor between the Trim and GND pins of the module. Certain restrictions apply on the output voltage set point depending on the input voltage. These are shown in the Output Voltage vs. Input Voltage Set Point Area plot in Fig. 41. The Upper Limit curve shows that for output voltages lower than 1V, the input voltage must be lower than the maximum of 12V. The Lower Limit curve shows that for output voltages higher than 0.6V, the input voltage needs to be larger than the minimum of 3V.

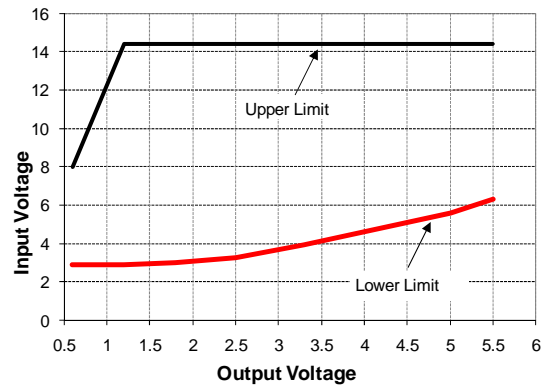

Figure 41. Output Voltage vs. Input Voltage Set Point Area plot showing limits where the output voltage can be set for different input voltages.

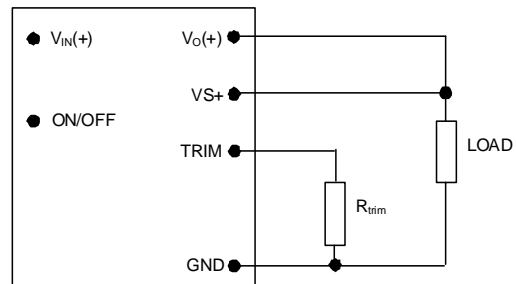

Figure 42. Circuit configuration for programming output voltage using an external resistor.

3A Analog PicoDLynx™: Non-Isolated DC-DC Power Modules

3Vdc –14.4Vdc input; 0.6Vdc to 5.5Vdc output; 3A Output Current

Without an external resistor between Trim and GND pins, the output of the module will be 0.6Vdc. To calculate the value of the trim resistor, R_{trim} for a desired output voltage, should be as per the following equation:

$$R_{trim} = \left[\frac{12}{(V_o - 0.6)} \right] k\Omega$$

R_{trim} is the external resistor in kΩ

V_o is the desired output voltage.

Table 1

$V_{o, set}$ (V)	R_{trim} (KΩ)
0.6	Open
0.9	40
1.0	30
1.2	20
1.5	13.33
1.8	10
2.5	6.316
3.3	4.444
5.0	2.727

Remote Sense

The power module has a Remote Sense feature to minimize the effects of distribution losses by regulating the voltage at the SENSE pin. The voltage between the SENSE pin and VOUT pin should not exceed 0.5V.

Voltage Margining

Output voltage margining can be implemented in the module by connecting a resistor, $R_{margin-up}$, from the Trim pin to the ground pin for margining-up the output voltage and by connecting a resistor, $R_{margin-down}$, from the Trim pin to output pin for margining-down. Figure 43 shows the circuit configuration for output voltage margining. The POL Programming Tool, available at www.lineagepower.com under the Downloads section, also calculates the values of $R_{margin-up}$ and $R_{margin-down}$ for a specific output voltage and % margin. Please consult your local GE technical representative for additional details.

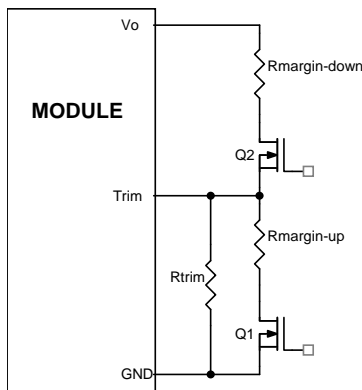

Figure 43. Circuit Configuration for margining Output voltage.

Overcurrent Protection

To provide protection in a fault (output overload) condition, the unit is equipped with internal current-limiting circuitry and can endure current limiting continuously. At the point of current-limit inception, the unit enters hiccup mode. The unit operates normally once the output current is brought back into its specified range.

Overtemperature Protection

To provide protection in a fault condition, the unit is equipped with a thermal shutdown circuit. The unit will shutdown if the overtemperature threshold of 135°C (typ) is exceeded at the thermal reference point T_{ref} . Once the unit goes into thermal shutdown it will then wait to cool before attempting to restart.

Input Undervoltage Lockout

At input voltages below the input undervoltage lockout limit, the module operation is disabled. The module will begin to operate at an input voltage above the undervoltage lockout turn-on threshold.

Power Good

The module provides a Power Good (PGOOD) signal that is implemented with an open-drain output to indicate that the output voltage is within the regulation limits of the power module. The PGOOD signal will be de-asserted to a low state if any condition such as overtemperature, overcurrent or loss of regulation occurs that would result in the output voltage going $\pm 10\%$ outside the setpoint value. The PGOOD terminal can be connected through a pullup resistor (suggested value 100KΩ) to a source of 5VDC or lower.

Dual Layout

Identical dimensions and pin layout of Analog and Digital PicoDLynx modules permit migration from one to the other without needing to change the layout. To support this, 2 separate Trim Resistor locations have to be provided in the layout. For the digital modules, the resistor is connected between the TRIM pad and SGND and in the case of the analog module it is connected between TRIM and GND

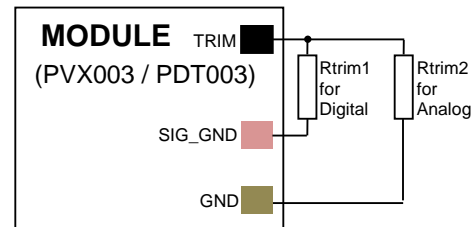

Caution – Do not connect SIG_GND to GND elsewhere in the layout

3A Analog PicoDLynx™: Non-Isolated DC-DC Power Modules

3Vdc –14.4Vdc input; 0.6Vdc to 5.5Vdc output; 3A Output Current

Figure 44. Layout to support either Analog or Digital PicoDLynx on the same pad.

Tunable Loop™

The 3A PicoDLynx™ modules have a feature that optimizes transient response of the module called Tunable Loop™.

External capacitors are usually added to the output of the module for two reasons: to reduce output ripple and noise (see Figure 38) and to reduce output voltage deviations from the steady-state value in the presence of dynamic load current changes. Adding external capacitance however affects the voltage control loop of the module, typically causing the loop to slow down with sluggish response. Larger values of external capacitance could also cause the module to become unstable.

The Tunable Loop™ allows the user to externally adjust the voltage control loop to match the filter network connected to the output of the module. The Tunable Loop™ is implemented by connecting a series R-C between the SENSE and TRIM pins of the module, as shown in Fig. 45. This R-C allows the user to externally adjust the voltage loop feedback compensation of the module.

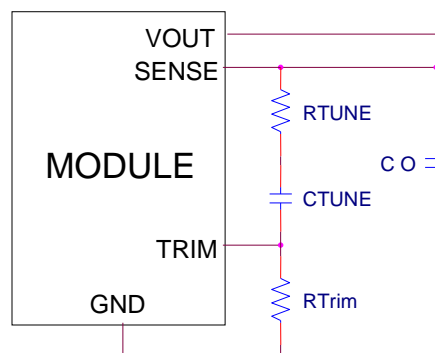

Figure 45. Circuit diagram showing connection of R_{TUNE} and C_{TUNE} to tune the control loop of the module.

Recommended values of R_{TUNE} and C_{TUNE} for different output capacitor combinations are given in Tables 2 and 3. Table 2 shows the recommended values of R_{TUNE} and C_{TUNE} for different values of ceramic output capacitors up to 1000uF that might be needed for an application to meet output ripple and noise requirements. Selecting R_{TUNE} and C_{TUNE} according to Table 2 will ensure stable operation of the module.

In applications with tight output voltage limits in the presence of dynamic current loading, additional output capacitance will be required. Table 3 lists recommended values of R_{TUNE} and C_{TUNE} in order to meet 2% output voltage deviation limits for some common output voltages in the presence of a 1.5A to 3A step change (50% of full load), with an input voltage of 12V.

Please contact your GE technical representative to obtain more details of this feature as well as for guidelines on how to select the right value of external R-C to tune the

3A Analog PicoDLynx™: Non-Isolated DC-DC Power Modules

3Vdc –14.4Vdc input; 0.6Vdc to 5.5Vdc output; 3A Output Current

module for best transient performance and stable operation for other output capacitance values or input voltages other than 12V.

Table 2. General recommended values of R_{TUNE} and C_{TUNE} for $V_{in}=12V$ and various external ceramic capacitor combinations.

C_O	1x47 μ F	2x47 μ F	4x47 μ F	6x47 μ F	10x47 μ F
R_{TUNE}	270	220	180	180	180
C_{TUNE}	1500p F	1800p F	3300p F	4700p F	4700pF

Table 3. Recommended values of R_{TUNE} and C_{TUNE} to obtain transient deviation of 2% of V_{out} for a 1.5A step load with $V_{in}=12V$.

V_o	5V	3.3V	2.5V	1.8V	1.2V	0.6V
C_O	1x47 μ F	1x47 μ F	2x47 μ F	1x330 μ F Polymer	1x330 μ F Polymer	2x330 μ F Polymer
R_{TUNE}	270	220	180	180	180	180
C_{TUNE}	1500p F	1800pF	3300pF	8200pF	8200pF	33nF
ΔV	68mV	60mV	37mV	18mV	18mV	10mV

Note: The capacitors used in the Tunable Loop tables are 47 μ F/3 m Ω ESR ceramic and 330 μ F/12 m Ω ESR polymer capacitors.

3A Analog PicoDLynx™: Non-Isolated DC-DC Power Modules

3Vdc –14.4Vdc input; 0.6Vdc to 5.5Vdc output; 3A Output Current

Thermal Considerations

Power modules operate in a variety of thermal environments; however, sufficient cooling should always be provided to help ensure reliable operation.

Considerations include ambient temperature, airflow, module power dissipation, and the need for increased reliability. A reduction in the operating temperature of the module will result in an increase in reliability. The thermal data presented here is based on physical measurements taken in a wind tunnel. The test set-up is shown in Figure 46. The preferred airflow direction for the module is in Figure 47.

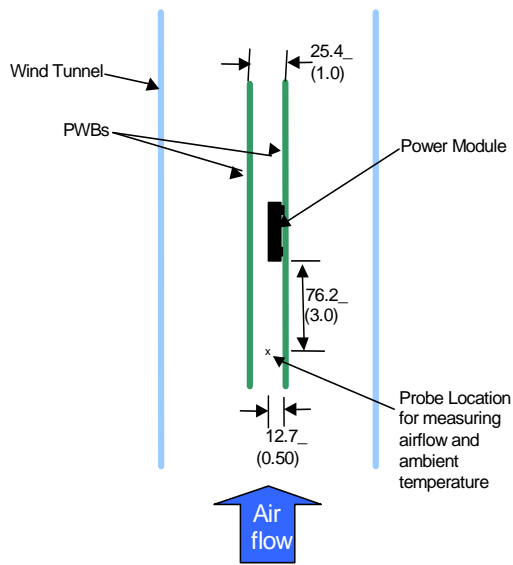

Figure 46. Thermal Test Setup.

The thermal reference points, T_{ref} used in the specifications are also shown in Figure 47. For reliable operation the temperatures at these points should not exceed 120°C. The output power of the module should not exceed the rated power of the module ($V_{o,set} \times I_{o,max}$).

Please refer to the Application Note “Thermal Characterization Process For Open-Frame Board-Mounted Power Modules” for a detailed discussion of thermal aspects including maximum device temperatures.

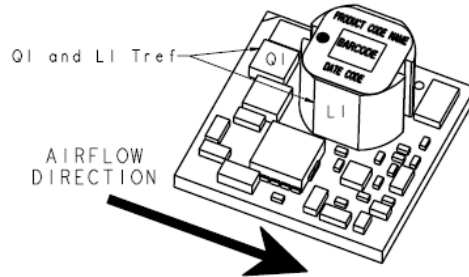

Figure 47. Preferred airflow direction and location of hot-spot of the module (T_{ref}).

3A Analog PicoDLynx™: Non-Isolated DC-DC Power Modules

3Vdc –14.4Vdc input; 0.6Vdc to 5.5Vdc output; 3A Output Current

Shock and Vibration

The ruggedized (-D version) of the modules are designed to withstand elevated levels of shock and vibration to be able to operate in harsh environments. The ruggedized modules have been successfully tested to the following conditions:

Non operating random vibration:

Random vibration tests conducted at 25C, 10 to 2000Hz, for 30 minutes each level, starting from 30Grms (Z axis) and up to 50Grms (Z axis). The units were then subjected to two more tests of 50Grms at 30 minutes each for a total of 90 minutes.

Operating shock to 40G per Mil Std. 810G, Method 516.4 Procedure I:

The modules were tested in opposing directions along each of three orthogonal axes, with waveform and amplitude of the shock impulse characteristics as follows:

All shocks were half sine pulses, 11 milliseconds (ms) in duration in all 3 axes.

Units were tested to the Functional Shock Test of MIL-STD-810, Method 516.4, Procedure I - Figure 516.4-4. A shock magnitude of 40G was utilized. The operational units were subjected to three shocks in each direction along three axes for a total of eighteen shocks.

Operating vibration per Mil Std 810G, Method 514.5 Procedure I:

The ruggedized (-D version) modules are designed and tested to vibration levels as outlined in MIL-STD-810G, Method 514.5, and Procedure 1, using the Power Spectral Density (PSD) profiles as shown in Table 1 and Table 2 for all axes. Full compliance with performance specifications was required during the performance test. No damage was allowed to the module and full compliance to performance specifications was required when the endurance environment was removed. The module was tested per MIL-STD-810, Method 514.5, Procedure I, for functional (performance) and endurance random vibration using the performance and endurance levels shown in Table 4 and Table 5 for all axes. The performance test has been split, with one half accomplished before the endurance test and one half after the endurance test (in each axis). The duration of the performance test was at least 16 minutes total per axis and at least 120 minutes total per axis for the endurance test. The endurance test period was 2 hours minimum per axis.

Table 4: Performance Vibration Qualification - All Axes

Frequency (Hz)	PSD Level (G ² /Hz)	Frequency (Hz)	PSD Level (G ² /Hz)	Frequency (Hz)	PSD Level (G ² /Hz)
10	1.14E-03	170	2.54E-03	690	1.03E-03
30	5.96E-03	230	3.70E-03	800	7.29E-03
40	9.53E-04	290	7.99E-04	890	1.00E-03
50	2.08E-03	340	1.12E-02	1070	2.67E-03
90	2.08E-03	370	1.12E-02	1240	1.08E-03
110	7.05E-04	430	8.84E-04	1550	2.54E-03
130	5.00E-03	490	1.54E-03	1780	2.88E-03
140	8.20E-04	560	5.62E-04	2000	5.62E-04

Table 5: Endurance Vibration Qualification - All Axes

Frequency (Hz)	PSD Level (G ² /Hz)	Frequency (Hz)	PSD Level (G ² /Hz)	Frequency (Hz)	PSD Level (G ² /Hz)
10	0.00803	170	0.01795	690	0.00727
30	0.04216	230	0.02616	800	0.05155
40	0.00674	290	0.00565	890	0.00709
50	0.01468	340	0.07901	1070	0.01887
90	0.01468	370	0.07901	1240	0.00764
110	0.00498	430	0.00625	1550	0.01795
130	0.03536	490	0.01086	1780	0.02035
140	0.0058	560	0.00398	2000	0.00398

3A Analog PicoDLynx™: Non-Isolated DC-DC Power Modules

3Vdc –14.4Vdc input; 0.6Vdc to 5.5Vdc output; 3A Output Current

Example Application Circuit

Requirements:

- V_{in}:** 12V
- V_{out}:** 1.8V
- I_{out}:** 2.25A max., worst case load transient is from 1.5A to 2.25A
- ΔV_{out}:** 1.5% of V_{out} (27mV) for worst case load transient
- V_{in} ripple:** 1.5% of V_{in} (180mV, p-p)

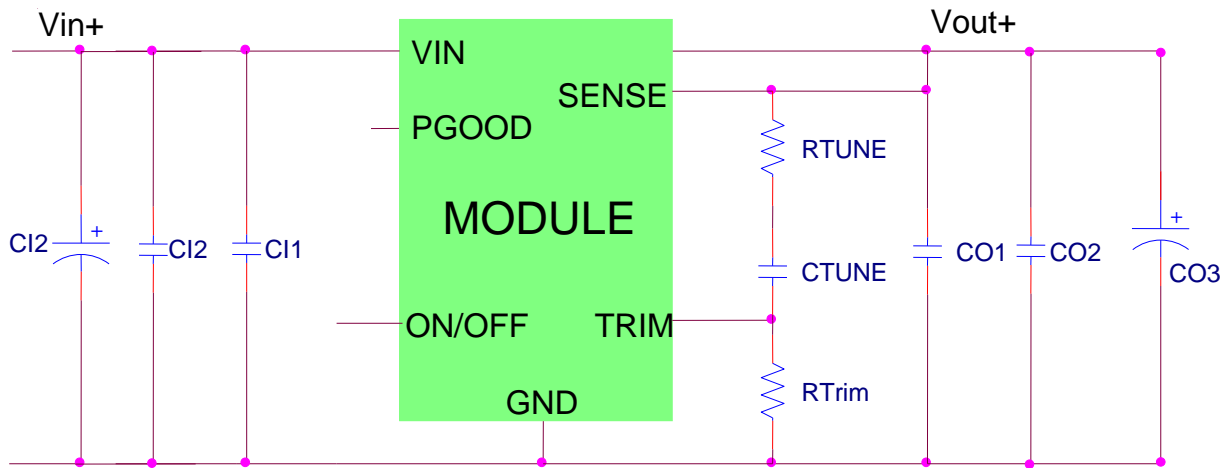

- C11 Decoupling cap - 1x0.047μF/16V ceramic capacitor (e.g. Murata LLL185R71C473MA01)
- C12 1x22μF/16V ceramic capacitor (e.g. Murata GRM32ER61C226KE20 or equivalent)
- C13 47μF/16V bulk electrolytic
- CO1 Decoupling cap - 1x0.047μF/16V ceramic capacitor (e.g. Murata LLL185R71C473MA01)
- CO2 2 x 47μF/6.3V ceramic capacitor (e.g. Murata GRM31CR60J476ME19 or equivalent)
- CO3 None
- CTune 2200pF ceramic capacitor (can be 1206, 0805 or 0603 size)
- RTune 261 ohms SMT resistor (can be 1206, 0805 or 0603 size)
- RTrim 10kΩ SMT resistor (can be 1206, 0805 or 0603 size, recommended tolerance of 0.1%)

3A Analog PicoDLynx™: Non-Isolated DC-DC Power Modules

3Vdc –14.4Vdc input; 0.6Vdc to 5.5Vdc output; 3A Output Current

Mechanical Outline

Dimensions are in millimeters and (inches).
 Tolerances: x.x mm ± 0.5 mm (x.xx in. ± 0.02 in.) [unless otherwise indicated]
 x.xx mm ± 0.25 mm (x.xxx in ± 0.010 in.)

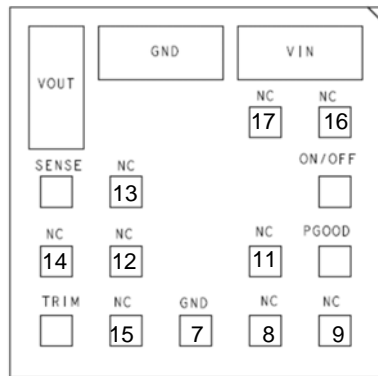
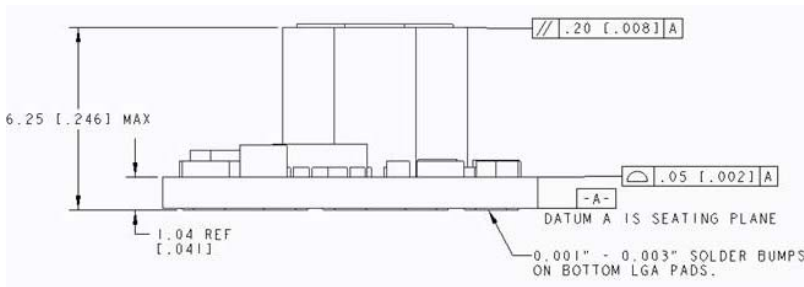
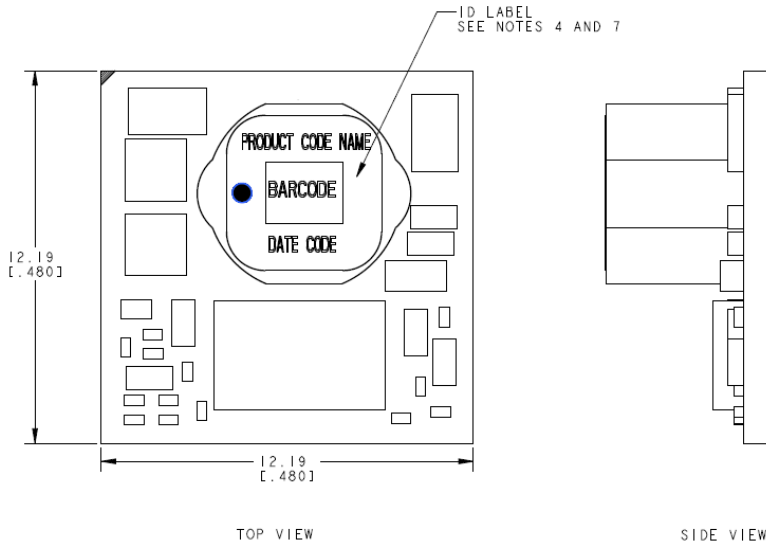

Bottom View

PIN	FUNCTION	PIN	FUNCTION
1	ON/OFF	10	PGOOD
2	VIN	11	NC
3	GND	12	NC
4	VOUT	13	NC
5	VS+(SENSE)	14	NC
6	TRIM	15	NC
7	GND	16	NC
8	NC	17	NC
9	NC		

3A Analog PicoDLynx™: Non-Isolated DC-DC Power Modules

3Vdc -14.4Vdc input; 0.6Vdc to 5.5Vdc output; 3A Output Current

Recommended Pad Layout

Dimensions are in millimeters and (inches).

Tolerances: x.xx mm ± 0.5 mm (x.xx in. ± 0.02 in.) [unless otherwise indicated]

x.xx mm ± 0.25 mm (x.xxx in ± 0.010 in.)

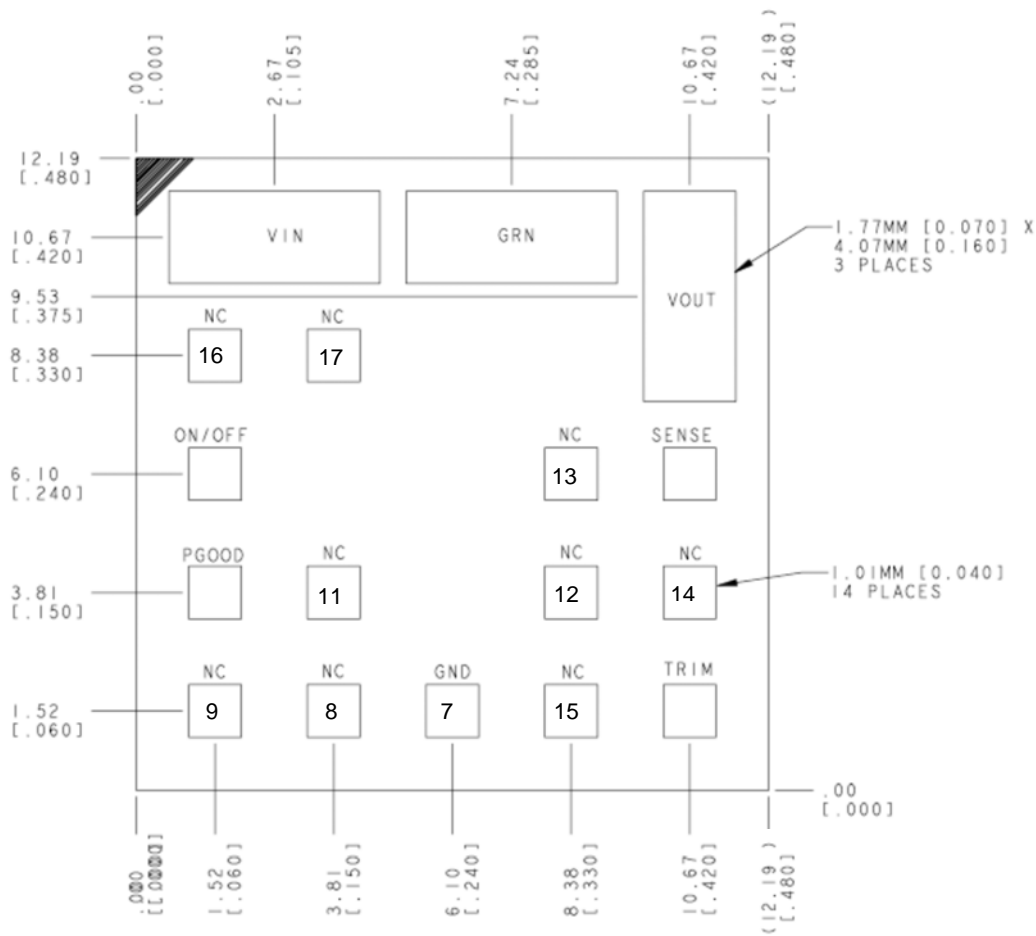

RECOMMENDED FOOTPRINT
-THROUGH THE BOARD-

PIN	FUNCTION	PIN	FUNCTION
1	ON/OFF	10	PGOOD
2	VIN	11	NC
3	GND	12	NC
4	VOUT	13	NC
5	VS+ (SENSE)	14	NC
6	TRIM	15	NC
7	GND	16	NC
8	NC	17	NC
9	NC		

3A Analog PicoDLynx™: Non-Isolated DC-DC Power Modules

3Vdc –14.4Vdc input; 0.6Vdc to 5.5Vdc output; 3A Output Current

Packaging Details

The 12V Analog PicoDLynx™ 3A modules are supplied in tape & reel as standard. Modules are shipped in quantities of 200 modules per reel.

All Dimensions are in millimeters and (in inches).

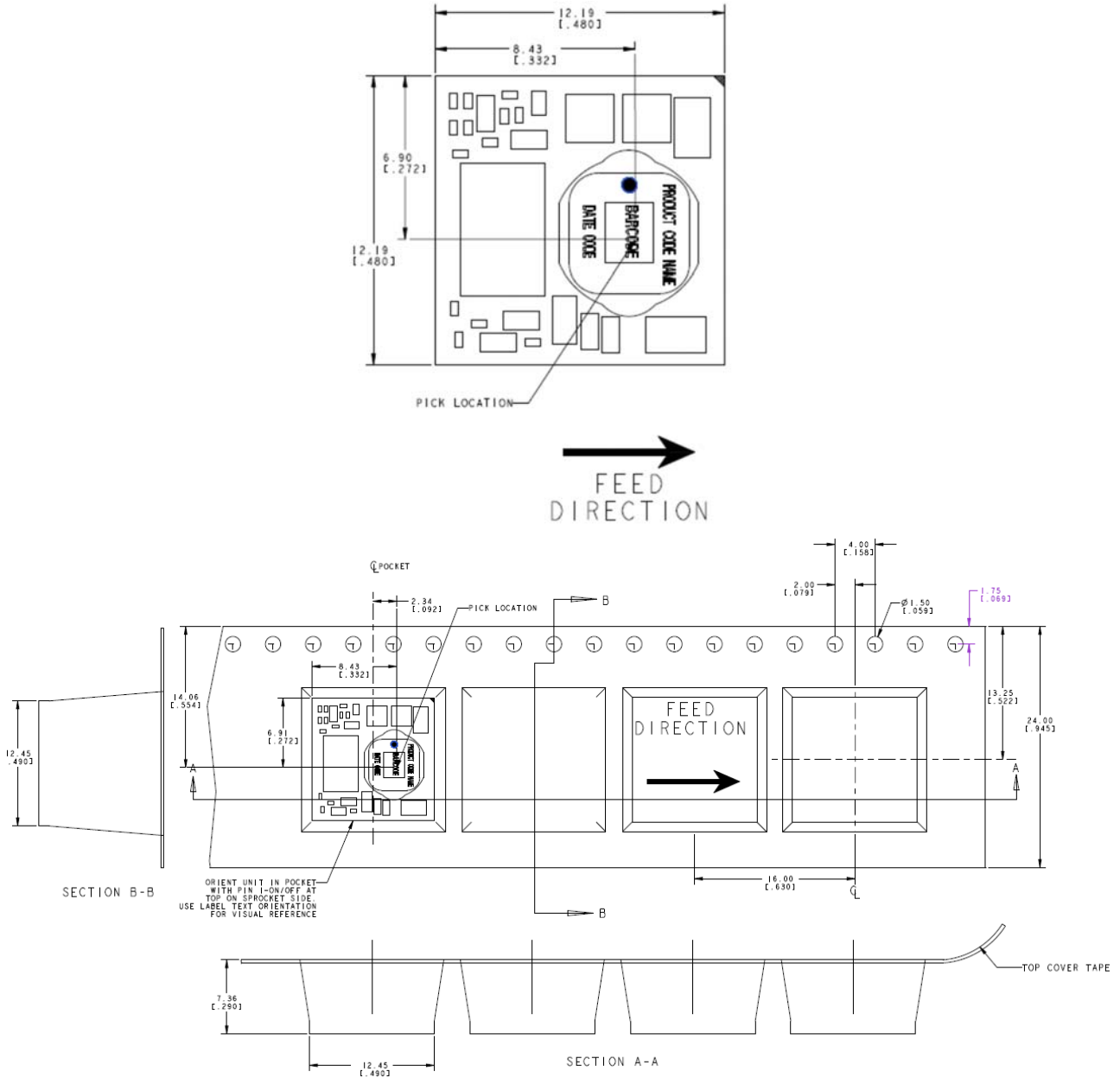

Reel Dimensions:	
Outside Dimensions:	330.2 mm (13.00)
Inside Dimensions:	177.8 mm (7.00")
Tape Width:	24.00 mm (0.945")

3A Analog PicoDLynx™: Non-Isolated DC-DC Power Modules

3Vdc –14.4Vdc input; 0.6Vdc to 5.5Vdc output; 3A Output Current

Surface Mount Information

Pick and Place

The 12VAnalog PicoDLynx™ 3A modules use an open frame construction and are designed for a fully automated assembly process. The modules are fitted with a label designed to provide a large surface area for pick and place operations. The label meets all the requirements for surface mount processing, as well as safety standards, and is able to withstand reflow temperatures of up to 300°C. The label also carries product information such as product code, serial number and the location of manufacture.

Nozzle Recommendations

The module weight has been kept to a minimum by using open frame construction. Variables such as nozzle size, tip style, vacuum pressure and placement speed should be considered to optimize this process. The minimum recommended inside nozzle diameter for reliable operation is 3mm. The maximum nozzle outer diameter, which will safely fit within the allowable component spacing, is 7 mm.

Bottom Side / First Side Assembly

Only the -D version of this module can be placed at the bottom side of the customer board. No additional glue or adhesive is required to hold the module during the top side reflow process

Lead Free Soldering

The 12VAnalog PicoDLynx™ 3A modules are lead-free (Pb-free) and RoHS compliant and are both forward and backward compatible in a Pb-free and a SnPb soldering process. Failure to observe the instructions below may result in the failure of or cause damage to the modules and can adversely affect long-term reliability.

Pb-free Reflow Profile

Power Systems will comply with J-STD-020 Rev. C (Moisture/Reflow Sensitivity Classification for Nonhermetic Solid State Surface Mount Devices) for both Pb-free solder profiles and MSL classification procedures. This standard provides a recommended forced-air-convection reflow profile based on the volume and thickness of the package (table 5-2). The suggested Pb-free solder paste is Sn/Ag/Cu (SAC). For questions regarding LGA, solder volume; please contact GE for special manufacturing process instructions.

The recommended linear reflow profile using Sn/Ag/Cu solder is shown in Fig. 48. Soldering outside of the recommended profile requires testing to verify results and performance.

It is recommended that the pad layout include a test pad where the output pin is in the ground plane. The

thermocouple should be attached to this test pad since this will be the coolest solder joints. The temperature of this point should be:

Maximum peak temperature is 260 C.

Minimum temperature is 235 C.

Dwell time above 217 C: 60 seconds minimum Dwell time

above 235 C: 5 to 15 second

MSL Rating

The 12VAnalog PicoDLynx™ 3A modules have a MSL rating of 2a.

Storage and Handling

The recommended storage environment and handling procedures for moisture-sensitive surface mount packages is detailed in J-STD-033 Rev. B (Handling, Packing, Shipping and Use of Moisture/Reflow Sensitive Surface Mount Devices). Moisture barrier bags (MBB) with desiccant are required for MSL ratings of 2 or greater. These sealed packages should not be broken until time of use. Once the original package is broken, the floor life of the product at conditions of $\leq 30^{\circ}\text{C}$ and 60% relative humidity varies according to the MSL rating (see J-STD-033A). The shelf life for dry packed SMT packages will be a minimum of 12 months from the bag seal date, when stored at the following conditions: $< 40^{\circ}\text{C}$, $< 90\%$ relative humidity.

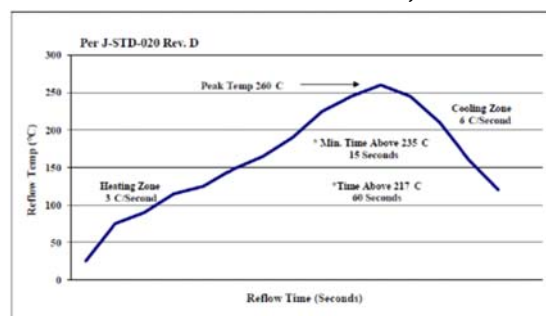

Figure 48. Recommended linear reflow profile using Sn/Ag/Cu solder.

Post Solder Cleaning and Drying Considerations

Post solder cleaning is usually the final circuit-board assembly process prior to electrical board testing. The result of inadequate cleaning and drying can affect both the reliability of a power module and the testability of the finished circuit-board assembly. For guidance on appropriate soldering, cleaning and drying procedures, refer to *Board Mounted Power Modules: Soldering and Cleaning Application Note (AN04-001)*.

3A Analog PicoDLynx™: Non-Isolated DC-DC Power Modules

3Vdc –14.4Vdc input; 0.6Vdc to 5.5Vdc output; 3A Output Current

Ordering Information

Please contact your GE Sales Representative for pricing, availability and optional features.

Table 6. Device Codes

Device Code	Input Voltage Range	Output Voltage	Output Current	On/Off Logic	Sequencing	Comcodes
PVX003A0X3-SRZ	3 – 14.4Vdc	0.6 – 5.5Vdc	3A	Negative	No	CC109159562
PVX003A0X3-SRDZ	3 – 14.4Vdc	0.6 – 5.5Vdc	3A	Negative	No	150021797
PVX003A0X43-SRZ	3 – 14.4Vdc	0.6 – 5.5Vdc	3A	Positive	No	CC109159570*

-Z refers to RoHS compliant parts

*Please contact GE for more information

Table 7. Coding Scheme

Package Identifier	Family	Sequencing Option	Output current	Output voltage	On/Off logic	Remote Sense	Options		ROHS Compliance
P	V	X	003A0	X	4	3	-SR	-D	Z
P=Pico U=Micro M=Mega G=Giga	D=DLynx Digital V = DLynx Analog.	T=with EZ Sequence X=without sequencing	3A	X = programmable output	4 = positive No entry = negative	3 = Remote Sense	S = Surface Mount R = Tape & Reel	D = 105°C operating ambient, 40G operating shock as per MIL Std 810G, placement on bottom side of board	Z = ROHS6

Contact Us

For more information, call us at

USA/Canada:

+1 888 546 3243, or +1 972 244 9288

Asia-Pacific:

+86.021.54279977*808

Europe, Middle-East and Africa:

+49.89.878067-280

www.gecriticalpower.com



GE Critical Power reserves the right to make changes to the product(s) or information contained herein without notice, and no liability is assumed as a result of their use or application. No rights under any patent accompany the sale of any such product(s) or information.