

**Front View
Interior**

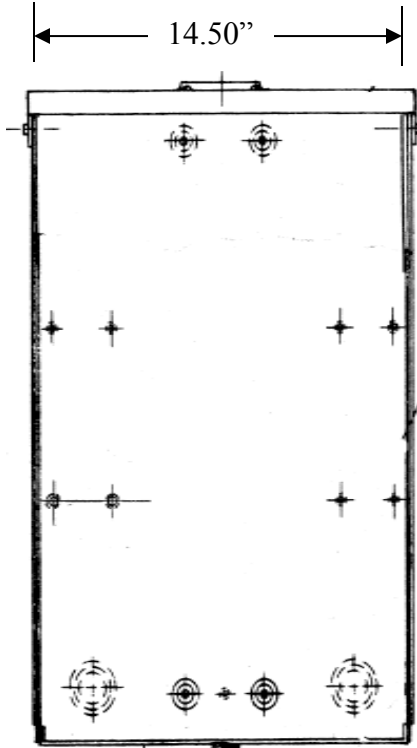

**Right
Side View**

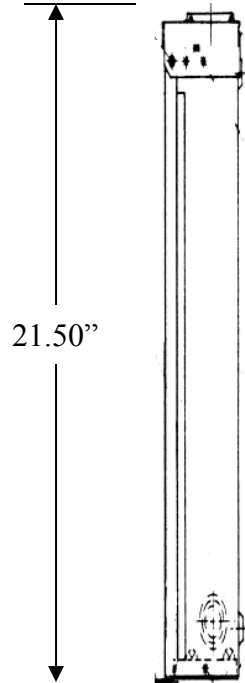

Wire Range Size

(3) 1/0 – 250MCM
(3) #12 – 1/0

Configuration

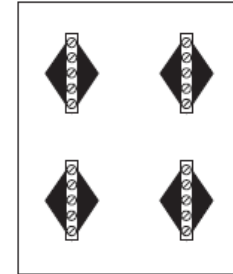

Top Feed

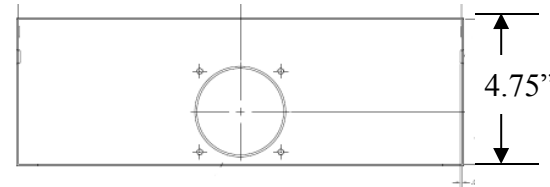

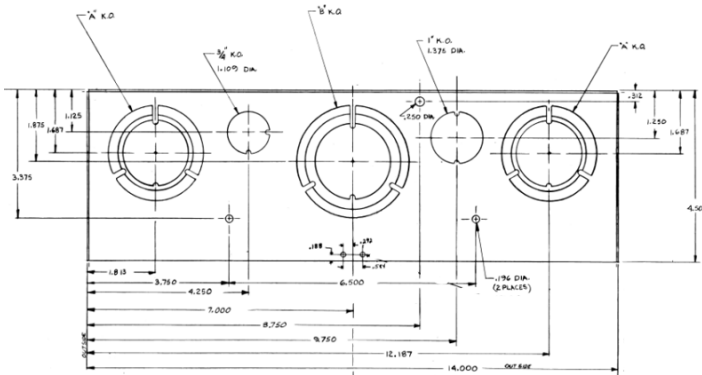

Bottom View

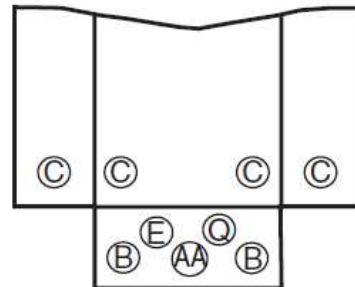

Knockout Key

- AA = 1-1/2", 2", 2-1/2"
- B = 1", 1-1/4", 1-1/2"
- C = 1-1/4", 1-1/2", 2"
- D = 3/4", 1", 1-1/4"
- E = 3/4"
- F = 1/2", 3/4"
- G = 1/2", 3/4", 1"
- H = 1/2", 3/4", 1", 1-1/4", 1-1/2"
- N = 2", 2-1/2", 3"
- Q = 1"





MIDWEST TERMINAL BOX 200A 3PH UL LISTED 240V
MAX N1/N3R G90 STEEL ENCLOSURE

CAT NO	DWG DATE	REV #
T3220	03/29/2017	01