

**Top View**

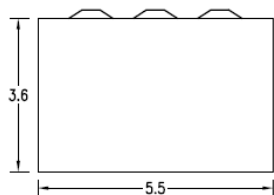

**Knockouts**

L= 1/2", 3/4" KO
G= 1/2", 3/4", 1" KO
M= 1/2", 3/4", 1", 1-1/4" KO

**Left Side View**

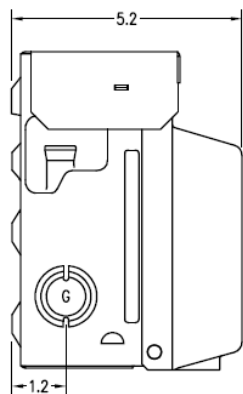

**Back View**

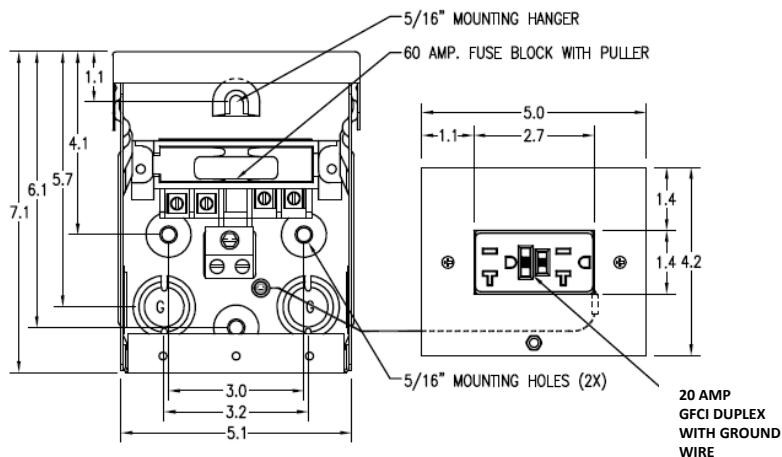

**Front Cover**

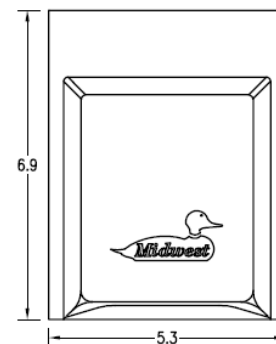

**Right Side View**

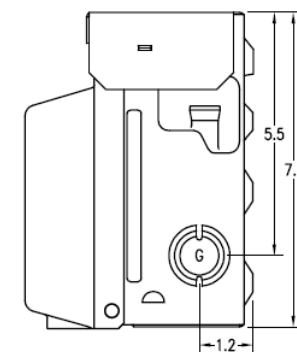

**Bottom View**

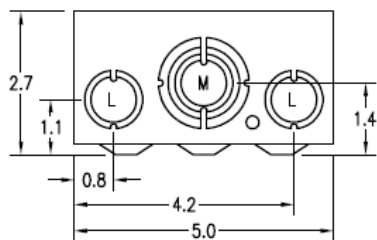

**Wire Range Size**

CONNECTOR	COPPER		ALUMINUM	
	SOLID	STRAND	SOLID	STRAND
LINE	14-8	14-2	12-8	12-2
LOAD	14-8	14-2	12-8	12-2
NEUTRAL	-----	-----	-----	-----
EQUIP. GRND.	12-8	12-2	12-8	12-2



MIDWEST 60A GD AC DISCONNECT PULLER-TYPE 240V  
NON-FUSIBLE 10HP 20A GFI RECEPT STEEL N3R ENCL

<b>CAT NO</b>	<b>DWG DATE</b>	<b>REV #</b>
U065PC2	04/10/2016	02