

DUAL DIMENSIONS INCHES (ESTIMATING ONLY)
(MILLIMETERS)

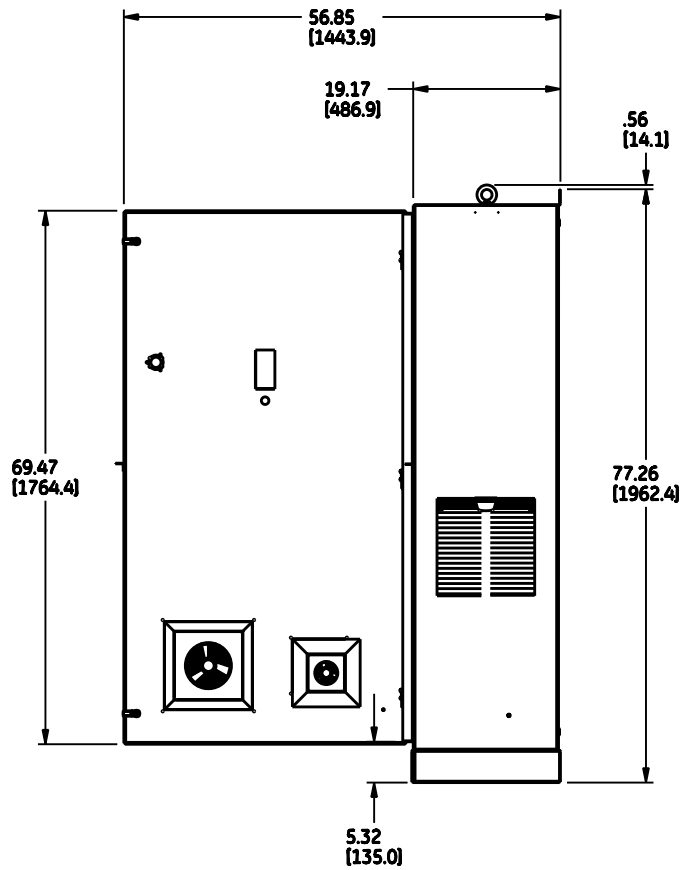

DOOR OPEN AT 90°

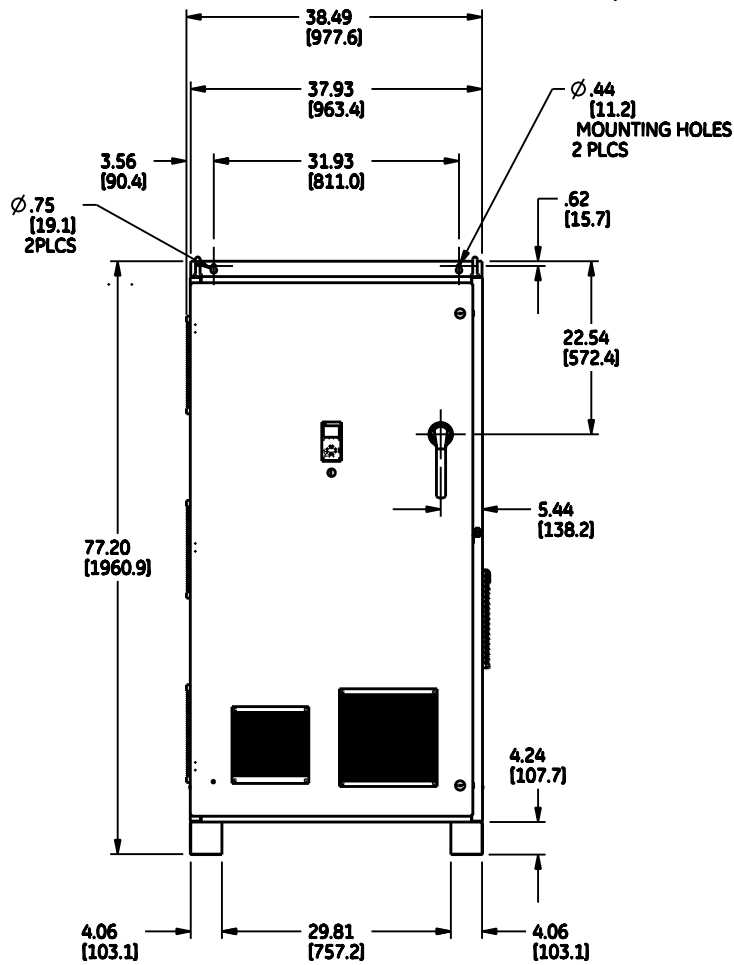
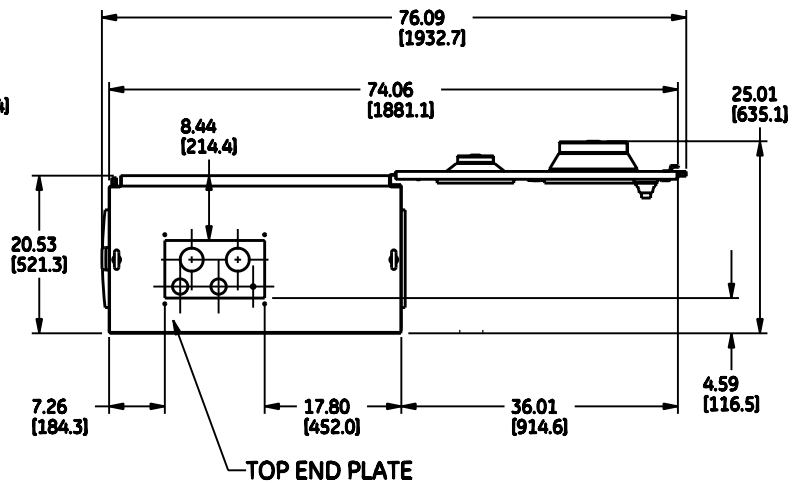
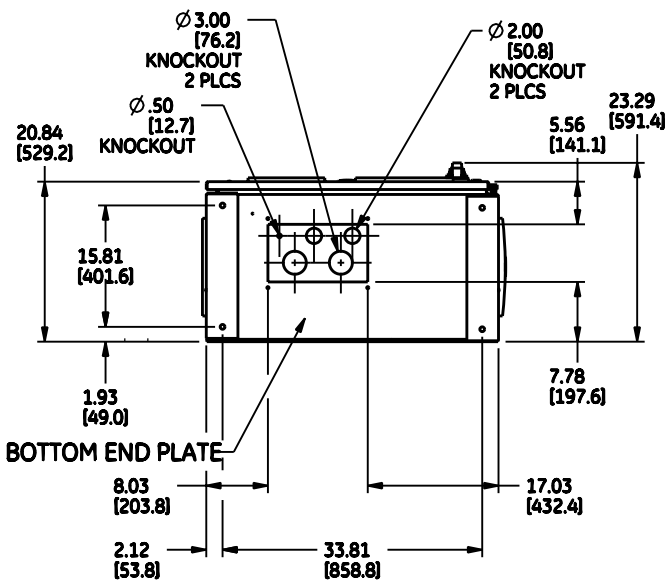

DOOR OPEN AT 180°

WEIGHT : 927LBS [420.56KGS]
 FP : 250-350HP@460V & 250-400HP@575V
 GP : 200-300HP@460V & 250-400HP@575V



GE Energy

OUTLINE-DRIVE DISCONNECT
 AF 600FP/650GP TYPE-1

AN #	THIRD ANGLE PROJECTION	SHEET #
BL-0466		1 OF 1

DWG NO.	DATE	REV
270A8165	10/21/11	3