



43R-5000B

Revised March, 1995
Supercedes January, 1995

OPERATION AND MAINTENANCE MANUAL

**AUTOMATIC
TRANSFER
SWITCH -
DELAYED
TRANSITION**
(Mechanically Held)

**ZTSDH SERIES
600 THRU 1200 AMPS**

CONTROLLED

MODEL NUMBER

SERIAL NUMBER

ZENITH CONTROLS, INC., 830 W. 40th St., Chicago, IL 60609
(312)247-6400: FAX. (312)247-7805

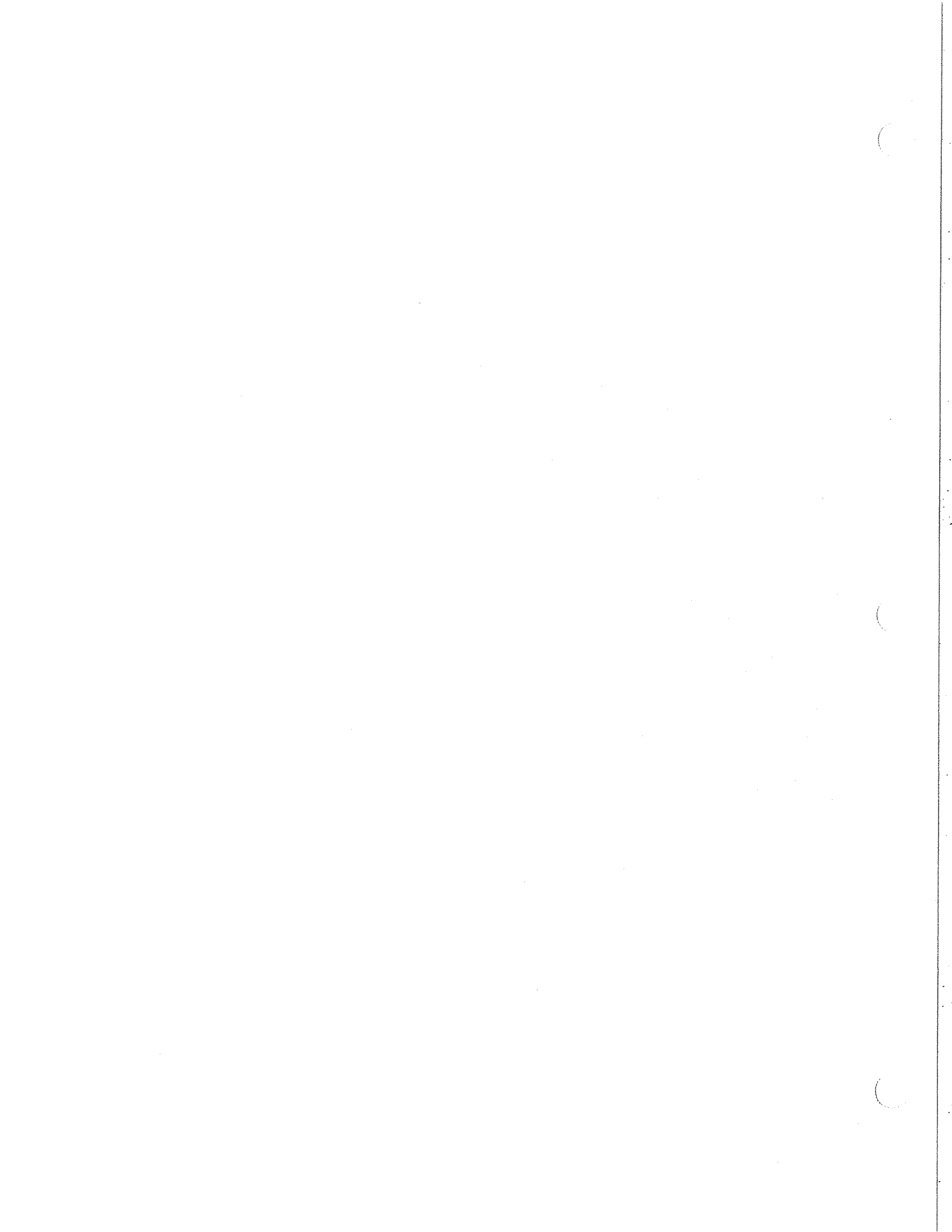

PARTS LIST

IMPORTANT: Model number and serial number of switch must be included with all orders for replacement parts. If possible, also specify line voltages, drawing number and date of installation. When ordering mechanical parts not shown on the parts list, circle the part on the photograph and return with the parts list. When ordering electrical components not shown on the parts list, refer to this part by its legend description in the wiring diagram.

A. POWER PANEL

ITEM	TAG	DESCRIPTION	600	800	1000	1200		
1	NL1,2,3,N EL1,2,3,N T1,2,3,N	Cable Connection LUG, CU WIRE	S1393F (2) 600 MCM-#2	S1392F (4) 600 MCM-#2	S1392F (4) 600 MCM-#2	S1392F (4) 600 MCM-#2		
2	*	Stationary Contact Assembly Kit	23P-1471	26P-1336	26P-1336	26P-1336		
3		Arc Grid Assembly Kit	23P-1366	23P-1366	23P-1366	23P-1366		
4	*	Movable Contact Assembly Kit	23P-1469	26P-1334	26P-1334	26P-1334		
		Movable Contact Se. Neut.	23P-1470	26P-1335	26P-1335	26P-1335		
5	CN/CNO CE/CEO	Main Operating Coils DC						
		VOLTAGE SYSTEM						
		No.	Volts	Ph	Wire	Coil Volts	Pole	
		-1	120	1	2	120	2	
								CONSULT FACTORY
		-2	120/240	1	3	240	3	K-2146
								K-2147
								K-2147
		-3	240	3	3	240	3	K-2146
								K-2147
		-4	120/208	3	4	208	3,4	K-2146
								K-2147
		-5	480	3	3	480	3	K-2158
						K-2157		
						CONSULT FACTORY		
-6	575	3	3	575/600	3			
						K-2157		
-7	277/480	3	4	480	3,4	K-2158		
						K-2157		
-8	120/240	2	4	240	4	K-2146		
						K-2147		
						CONSULT FACTORY		
-9	240/416	3	4	416	3			
						CONSULT FACTORY		
OPERATING COIL HARDWARE KIT								
6	RN/RNO	Coil Rectifier	23P-1473 (was PS-4870)					
	RE/REO		23P-1397					
7	SN/SNO	CN/CNO	23P-1397					
	SE/SEO	CE/CEO	Cut-out Switch					
8	A3	Emerg. Position Aux. Contact	(Qty. 1) 23P-1389 (Qty. 2) 23P-1390					
9	A4	Norm. Position Aux. Contact	(Qty. 1) 23P-1393 (Qty. 2) 23P-1394					
10	DS	Disconnect Switch	Operator L4009; Contact Block L1020					
11		Nameplate	Contains switch information: voltage, amperage, frequency rating, number of phases, serial number, system voltage and model number					

CABINET DOOR

TAG	DESCRIPTION	PART NO.
L1 L2	ATS Emergency Position Indicator ATS Normal Position Indicator Green Lens (Normal) Red Lens (Emergency) Bulb Socket Normal/Emergency Nameplate Emergency Bulb Normal Bulb	PS-5048 PS-5047 PS-5046 V-1501 PS-5105 PS-5105
TS	Test Switch Operator, Momentary Contact Block N.C. Name Plate Contact Mounting Base	L-1025 L-1029 V-1503 PS-3473

CONTROLLED

D. ATS CONTROL PANEL (SSRCP)

CHART 1

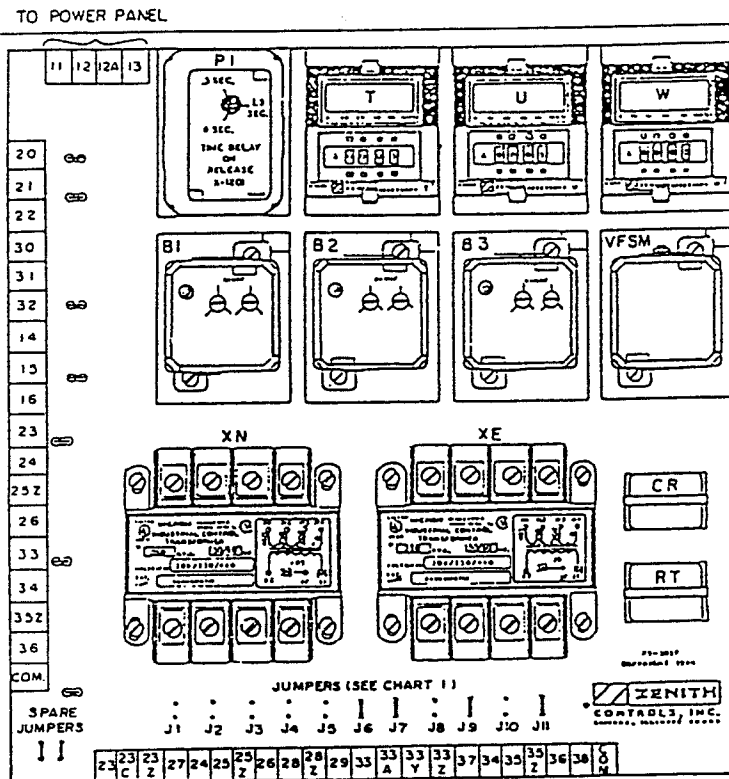

Jumper	Connects Points	Remove When Accessories Used
J1	23,23A	B1
J2	23A, 23B	B2
J3	23B, 23C	B3
J4	23C, 23Z	JIN, TS, C/D
J5	23Z, 27	T, YN
J6	25, 25Z	T3, R4
J7	28, 28Z	SI, C, C/D
J8	28Z, 29	PI & U
J9	33A, 33Y	ER1, 2, 3, J1E
J10	33Z,37	W
J11	35, 35Z	R4, W3

CONTROLLED

ATS CONTROL PANEL (SSRCP) STANDARD ITEMS

TAG	DESCRIPTION	VOLTAGE 50/60 HZ	PART NO.
XN, XE	Control Transformers (See Note 1)	120V	K-3068
		208V	K-3070
		240 or 480V	K-3071
		416V	K-3089
B-1, 2, 3	Phase Relays Solid State (See Note 1)	120V	K-1185
		208 or 240V	K-1186
		480V	K-1188
VFSM	Voltage Frequency Sensor	120V/60 Hz	K-1192R
CR	Control Relay	120V	K-1204
RT	Bypass T Relay	120V	K-1204
J1-J11	Jumpers		PS-5067
CCN, CCEO	Power Relays, energize CN & CEO Solenoids	120V	K-1120
CCE, CCNO	Power Relays, energize CE & CNO Solenoids	120V	K-1120
(OPTIONAL ITEMS)			
TAG	DESCRIPTION	VOLTAGE	PART NUMBER
T	Time Delay to Normal, Timer Solid State	120V .1 Sec. to 9990 Hrs. (Adj.)	OSA-A-T
U	Engine Cool Down, Timer Solid State	120V .1 Sec. to 9990 Hrs. (Adj.)	OSA-A-U
W	Time Delay Emergency, Timer Solid State	120V .1 Sec. to 9990 Hrs. (Adj.)	OSA-A-W
PI	Time Delay Engine Start, Timer	120V (.5 to 6 sec. Adjustable)	K-1201
P2	Optional (Mounted below SSRCP)	120V (300 Sec. Adjustable)	K-1061

Notes:

- If -6 voltage system (575/600V) is supplied, then XN, XE is K-3087 and B1,2, 3 is K-1185 (120V) supplied with XB (575;600V/120V) 3 phase transformer assembly. B1, 2, 3 mounted below SSRCP.

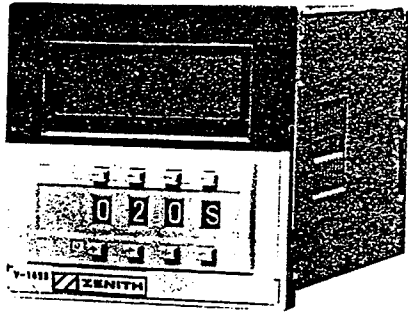

Solid State Time Delay

Accessories T, U, W Solid State Timers Adjustable in Seconds, Minutes and Hours (Plug-In Style).

To select a time unit, operate the pushbuttons of the rightmost thumbwheel switch until the desired time unit is shown in window. The time unit can be selected by pushing the plus (+) bottom button or the minus (-) top button. The desired time is specified by operating the three thumbwheel switches in the middle of the front panel.

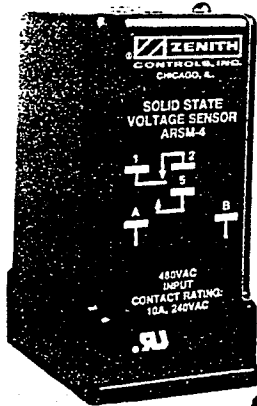

Close Differential (ARSM) Relay Adjustment

The voltage points at which the relay operates are adjustable. When the relay pulls in, an audible click is noticeable, and the LED will come on.

Setting the Relay:

If the relay should be set with a variable voltage supply (Variac):

1. Turn pick-up control fully clockwise.
2. Turn drop-out control fully counterclockwise.
3. Set Variac pick-up voltage to desired level.
4. **Very slowly** rotate pick-up adjustment counterclockwise until relay picks up. (LED will energize).
5. Set Variac drop-out voltage to desired level.
6. **Very slowly** rotate drop-out adjustment clockwise until relay drops out (LED de-energizes).

Verify settings by raising voltage until relay picks up, then lower voltage until relay drops out, making sure that relay operates at desired voltage levels.

CONTROLLED

VOLTAGE/FREQUENCY SENSOR (VFSM) ADJUSTMENT

The pickup point may be adjusted between 80-95% of rated voltage by rotating the offset screw located on the back of the relay.

Counter-clockwise rotation increases pickup voltage. Clockwise rotation decreases pickup voltage.

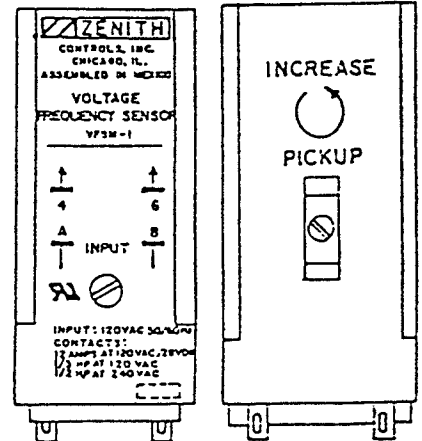

NL1,2,3,NN NORMAL SOURCE

T1, 2,3,TN LOAD

EL 1, 2,3,EN EMERGENCY SOURCE

- LEGEND :
- WIRE CONNECTION
 - WIRE ON MAIN TERMINAL BLOCK
 - ↔ WIRE ON DISCONNECT PLUG.
 - * OPTIONAL ACCESSORIES
 - SWITCHED NEUTRAL OR SOLID NEUTRAL } IF REQUIRED
 - MECHANICALLY ACTUATED EMERGENCY POSITION CONTACTS.

MECHANICALLY ACTUATED NORMAL POSITION CONTACTS

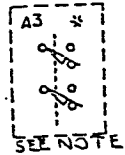
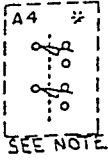

- CN - SOLENOID COIL, TRANSFERS ATS FROM NEUTRAL TO NORM. POSITION.
- CE - SOLENOID COIL, TRANSFERS ATS FROM NEUTRAL TO EMER. POSITION.
- CNO - SOLENOID COIL, TRANSFERS ATS FROM NORMAL TO NEUTRAL POSITION
- CEO - SOLENOID COIL, TRANSFERS ATS FROM EMERG. TO NEUTRAL POSITION
- RN - CN RECTIFIER
- RE - CE RECTIFIER
- RNO - CNO RECTIFIER
- REO - CEO RECTIFIER

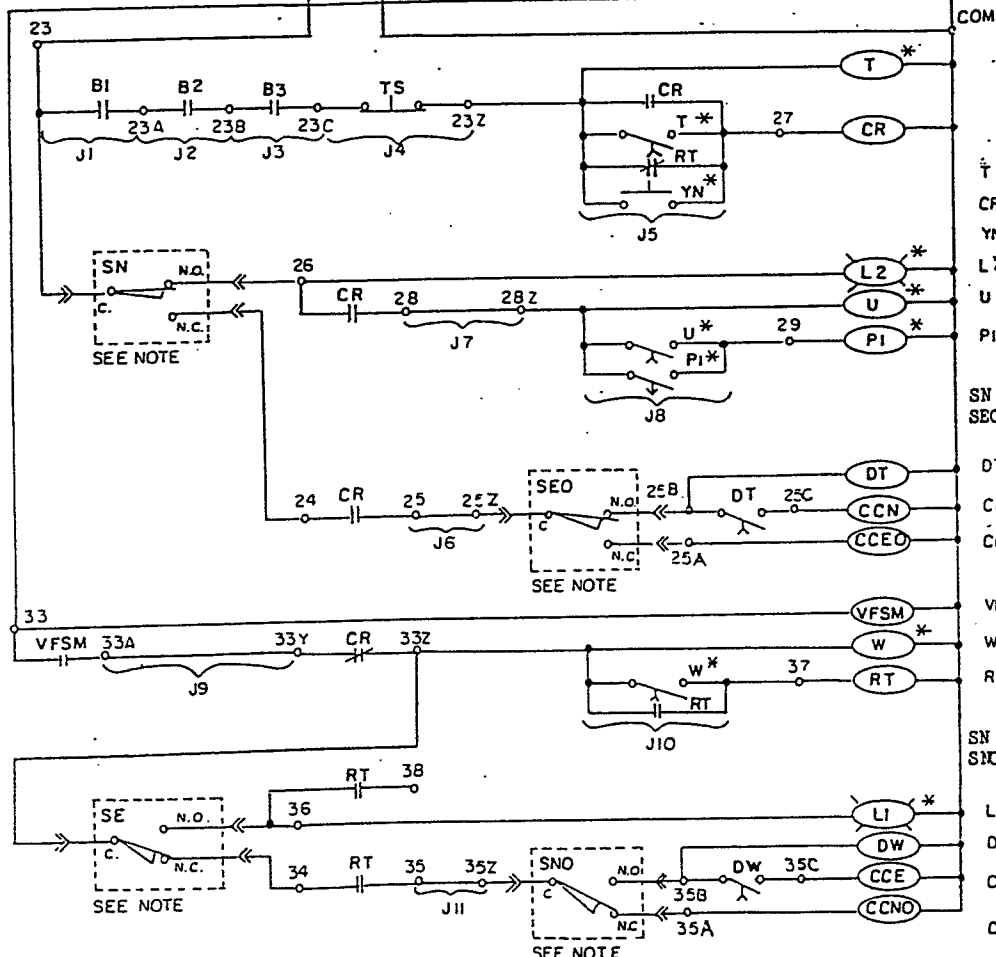

VOLTS 160 Hz	NO. OF PHASES	NO. OF WIRES
3 240	3	3
4 120/208	3	4
5 480	3	3
7 277/480	3	4
9 240/416	3	4
38 120/240	3	4

- T - TIME DELAY ON RETRANSFER, 2
- CR - CONTROL RELAY, 27, 33, 39, 43
- YN - PUSH BUTTON TO BYPASS T.
- L2 - NORMAL POSITION LIGHT
- U - ENGINE OVER-RUN TIMER, 34
- PI - ADJUSTABLE TIME DELAY TO ENGINE START, 35, 55
- SN - MECHANICALLY ACTUATED CONTACTS (NORMAL POSITION)
- SEO - TIME DELAY IN NEUT. TO NORMAL, 39
- CCN - POWER RELAY, ENERGIZES SOLENOID CN, 11
- CCEO - POWER RELAY, ENERGIZES SOLENOID CEO, 15
- VFSM - EMER. VOLTAGE FREQUENCY SENSITIVE RELAY, 43
- W - TIME DELAY TO EMER. TRANSFER, 44
- RT - BYPASS T CONTACT IF EMERGENCY FAILS, 29, 45, 47, 50
- SN - MECHANICALLY ACTUATED CONTACTS (EMERGENCY POSITION)
- LI - EMER. POSITION LIGHT
- DW - TIME DELAY IN NEUT. TO EMER., 50
- CCE - POWER RELAY, ENERGIZES SOLENOID CE, 16
- CCNO - POWER RELAY, ENERGIZES SOLENOID CNO, 13

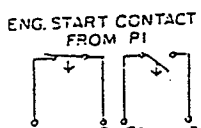

NOTE: LOCATED ON POWER PANEL.

CONTROLLED

OPERATION OF AUTOMATIC TRANSFER SWITCH

OPERATION:

When the normal line (NL) falls to the preset dropout point, or if any normal phase fails, the phase relay(s) (adjustable) will drop out disconnecting the CR and signaling the generator to start.

When emergency line (EL) voltage and frequency reach at least 90% of rated value, the VFSM relay is energized. The RT relay is now energized to operate the CCNO relay through the CNO cutout switch causing the main transfer coil CNO to operate. The load is now transferred to the OPEN position. The SNO limit switch operates to disconnect the CCNO relay and CNO transfer coil. The transfer switch is now locked mechanically open. SNO is now activated. This energizes the DW timer. After time setting has lapsed, DW will energize CCE, which will energize main transfer coil CE. The load is now transferred to the emergency line supply. The SE limit switch operates to disconnect the CCE relay and CE main transfer coil. The transfer switch is now locked mechanically in Emergency position.

When the normal line voltage restores to the preset value, the phase relay(s) (B1,2,3) operate to energize the normal restoration timer T. After the time setting has lapsed, the timer contact closes to energize CR relay. The CCEO relay is now energized through the SN and SEO limit switches, causing the main transfer coil CEO to operate. The load is now transferred back to OPEN position. The SEO limit switch operates to disconnect the CCEO relay and CEO transfer coil. The transfer switch is now locked mechanically open. SEO is now activated, energizing DT timer. After time setting has lapsed, DT will energize CCN which will energize main transfer coil CN. The load is now transferred to the normal line supply. The SN limit switch operates to disconnect the CCN relay and CN main transfer coil. The transfer switch is now locked into normal position.

INSPECTION

CONTACTS - The movable and stationary contacts are a vital part of the ATS and must be kept clean. To inspect the ATS contacts, disconnect all power sources. Examine the contacts.

Any surface deposits must be removed with a clean cloth (DO NOT USE EMERY CLOTH OR A FILE).

After the movable and stationary contacts are wiped clean (no discoloration or deposits), reconnect power source.

CURRENT CARRYING PARTS - An easily detected but abnormal condition is the discoloration of current carrying parts (particularly copper). Discoloration appears as darkened material or finishes. Any discolored parts should be cleaned. **WARNING: ANY MAINTENANCE SHOULD ONLY BE DONE WHILE THE POWER IS OFF.** If the discoloration persists, contact the factory.

LUBRICATION

The cams of the ATS are lubricated with Super Lube PTFE grease, the gears with Dow Chemicals "Molykote" (321R or GN paste). These lubricants provide adequate lubrication for a clean and properly maintained switches lifetime. Should debris contaminate the mechanism, clean and apply additional lubricants. Mobiltemp SHC-32 is used on isolating contacts.

CONTROLLED

PURPOSE

Zenith automatic transfer switches are used to provide a continuous source of voltage for lighting and power circuits by automatically transferring the lighting or power load from the normal source to an emergency source of voltage when the normal voltage fails or drops in voltage.

This manual is supplied to provide complete information on the operation, installation and maintenance of the ZENITH ZTSDH series mechanically held transfer switch. In addition a complete wiring diagram is provided with each transfer switch. The instruction manual and the wiring diagram should be kept in a safe place to serve as complete reference information on this critically important piece of equipment.

Described in this manual, are the new ZTSDH series, 600 thru 1200 ampere sizes, featuring a new concept in transfer switch design.

For details of operation, accessories, and wiring see wiring diagram and operational sheet supplied with the switch.

WARNING

The power voltage present in this equipment is dangerous to life. When operating or adjusting this equipment with doors open, special care must be taken to avoid contact with terminals carrying this voltage.

CONTACT REPLACEMENT

Contact replacement is usually not necessary for many years on the average transfer switch. When replacement is necessary, all contacts are easily removed. Both the main

contacts and all control contacts are easily visible from the front of the panel, for fast visual inspection.

INSTALLATION

A good installation is as necessary as a good transfer switch. This switch is designed for floor mounting. Floor mounted cabinets must be well braced and protected from damage. Be sure that the cabinet is not mounted directly under any water pipes which may sweat and drip water into the cabinet. Be sure cabinet is fully cleaned of dirt and concrete dust before operation.

Enough room should always be allowed to open the cabinet doors fully, so normal visual inspection of all parts is possible.

Before installing the switch and before energizing the circuits, check the switch for shipping or installation damage.

The following may be used as a test procedure after installation of the transfer switch:

Before connecting the load circuit, make sure normal line contacts are closed, then energize the NL circuit. The phase relays and control relay will be energized. Next, energize the EL circuit. The VFSM relay will be energized. Operate the test switch TS to the test position. The switch will transfer to the EL side. Return the test switch to the auto position. The transfer switch will restore to the NL position. The load may now be connected and the same procedure followed. A periodic test of the switch, under load conditions, is recommended to insure proper operation of the main switch and all accessories.

CHECK LIST FOR START-UP

NORMAL OPERATION		POINTS TO CHECK IF NORMAL OPERATION DOES NOT OCCUR
1	Normal line fails and the engine starts. (This can be simulated with the TEST switch).	If engine generator does not start be sure the relay containing the engine start contacts (marked E) has dropped out and the contacts are closed. Be sure the battery is connected and the control switch on the engine is turned to automatic. If the engine fires but does not start, contact the engine dealer.
2	Engine starts, generator reaches full voltage, switch transfers to emergency voltage.	Check at emergency line terminals of switch to be sure the generator voltage is up to the proper value. Be sure the VFSM relay pulls in. If not, check VFSM relay adjustment page 4. Check to see that the RT relay is energized. Check to see that the circuit to the CCNO coil (to open Normal), then CCE coil (to close Emergency) is complete thru the SE cutout switch.
3	Normal voltage restores and the switch transfers back to normal.	Check to see that the normal voltage has restored to full value. Check to see that the phase relays have pulled in. (See phase relay adjustment page 4. Check the CR relay to be sure that it is energized and its normal contact is closed. Check to see that the circuit to the CCEO coil (to open Emergency), then CCN coil (to close Normal) is complete thru the SN cutout switch.
4	Engine shuts down.	Be sure voltage is present at relay containing E contact and the relay is energized. If timer U is used be sure it times out and operates its end-of-cycle switch.



ZENITH
CONTROLS, INC.

830 W. 40th St., Chicago, Illinois 60608

