

REVISIONS			
REV.	DESCRIPTION	DATE	APPROVED
A	S-8949 ESTABLISH DRAWING	3/19/10	YP MAS

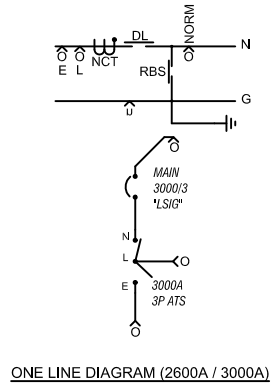

SYMBOL LEGEND
 O & u = MECH. LUGS (SEE TABLE FOR DETAILS)
 NCT = NEUTRAL CURRENT SENSOR
 RBS = REMOVABLE GROUND STRAP
 DL = NEUTRAL DISCONNECT LINK
 N = NORMAL
 E = EMERGENCY
 L = LOAD

NOTES:		
SYSTEM RATING: 100KA		
ENCLOSURE:	NEMA 1 TYPE	LABELS
INSTALLATION:	FLOOR MOUNTED	1. UL891 (ON INNER SIDE OF DOOR)
FINISH:	ANSI 61 GRAY	2. SUITABLE FOR AS SERVICE ENTRANCE
ACCESS:	REAR & SIDES	3. SERVICE DISCONNECT
COMPONENTS RATING AND SPECIFICATIONS (ATS):		
SERVICE ENTRANCE:	2600-3000A, 3 POLE UNIT, FULLY RATED	4. UL COMPLIANCE SHEET
SHORT CIRCUIT WITHSTAND AND CLOSING RATING (UL)	100KA @ 480V	5. SECTION AMPACITY
CIRCUIT BREAKER:		
GE PBII-ICCB, MICRO-VERSA TRIP PLUS, LSIIG TRIP UNIT		
MOUNT TYPE:	STATIONARY	6. 500-1000 MCM TORQUE
SIZE:	3000AF/3000AT-2500AT	7. NEMA 1 ENCLOSURE
SHORT CIRCUIT INTERRUPT RATING	100KAIC @ 480V	8. NEUTRAL TO GROUND LINK
U.L. LABEL	891	9. HIGH VOLTAGE DANGER
"SUITABLE TO USE AS SERVICE ENTRANCE EQUIPMENT"		
BUS:		
MATERIAL:	COPPER 1000A/in (3-1/4" X 4" PHASE/NEUTRAL)	
	(1-1/4" X 2" GROUND BUS)	
FINISH:		
SILVER PLATED		
CABLE:		
52-N	(8)-600Kcmil PER PHASE & NEUTRAL	
LOAD	(8)-600Kcmil PER PHASE & NEUTRAL	
EMERGENCY	(8)-600Kcmil PER PHASE & NEUTRAL	
GROUND	SPACE FOR UP TO (24)-1/0-250Kcmil LUG	

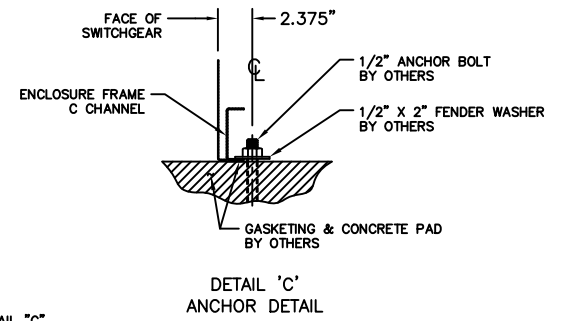
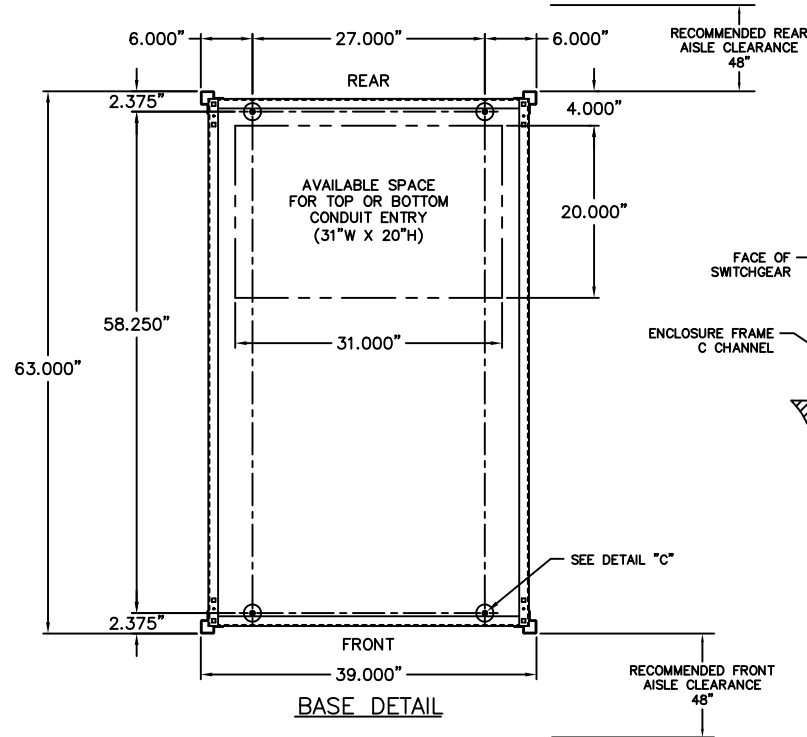
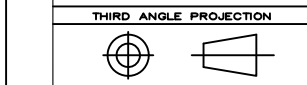
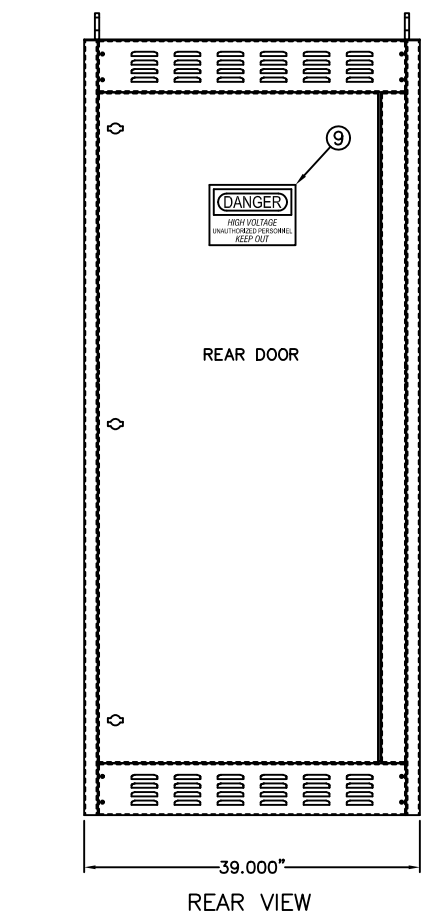
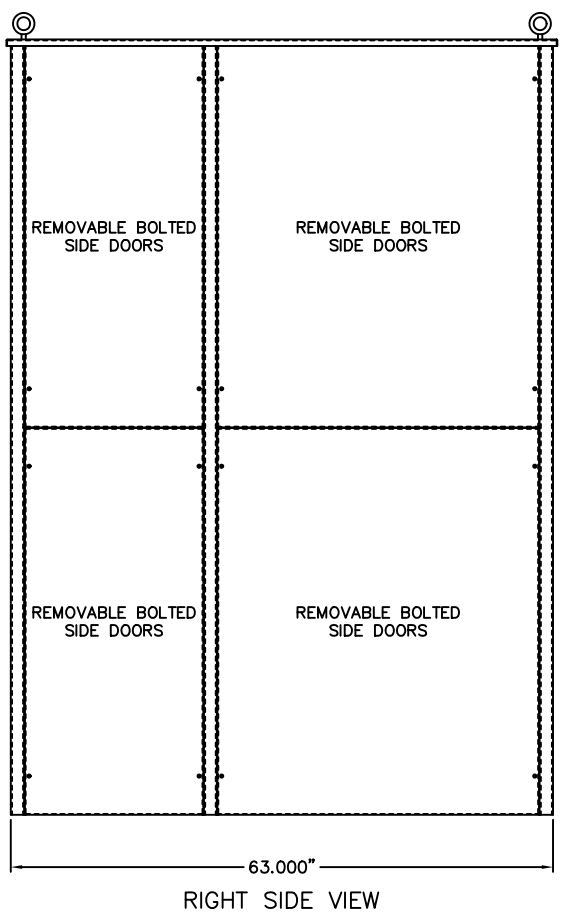
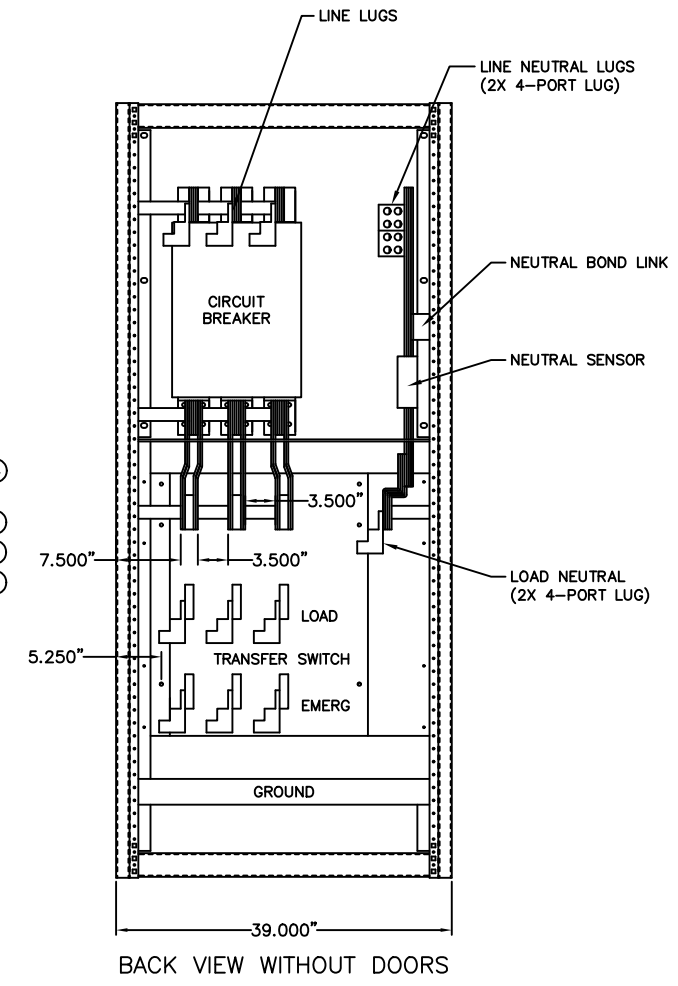
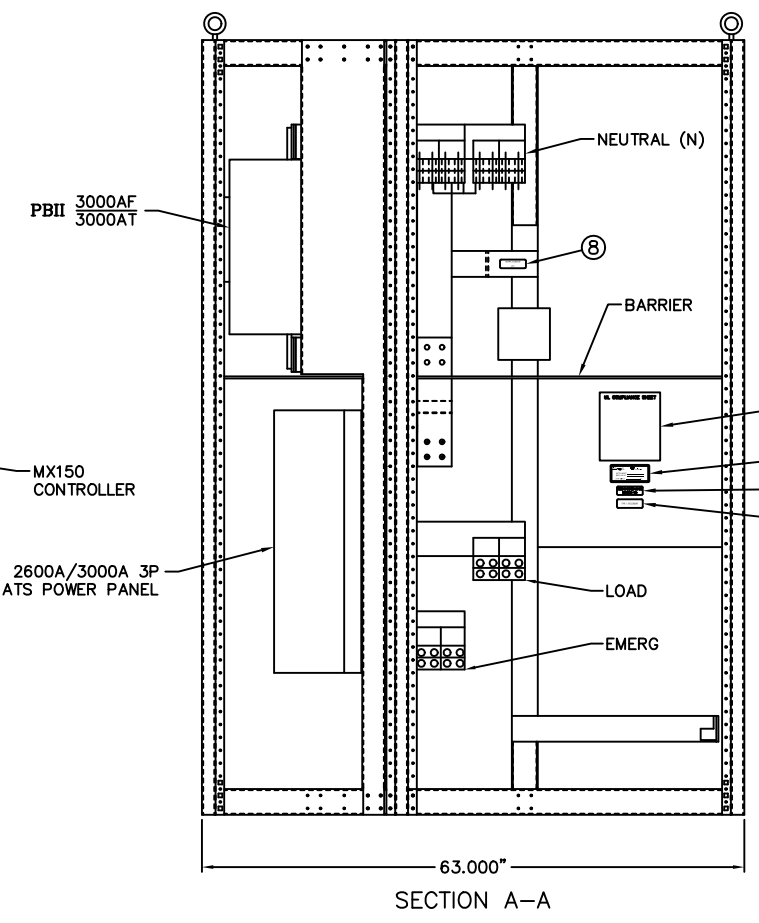
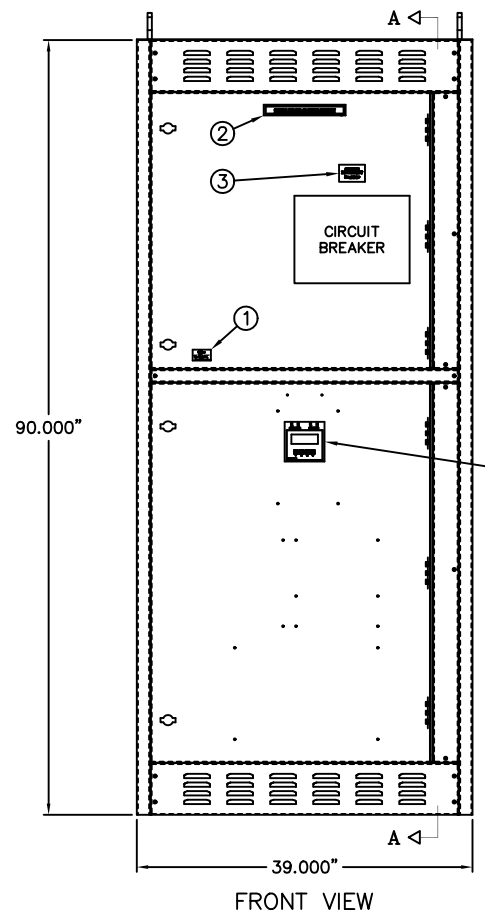

GE PROPRIETARY AND CONFIDENTIAL INFORMATION
 This document is the property of General Electric Company ("GE") and contains proprietary information of GE. This document is loaned on the express condition that neither it nor the information contained therein shall be disclosed to others without the express written consent of GE Industrial Systems, and that the information shall be used by the recipient only as approved expressly by GE Industrial Systems. This document shall be returned to GE upon its request. This document may be subject to certain restrictions under U.S. export control laws and regulations.

FOR ADDITIONAL INFO REFER TO	SIGNATURES	DATE	
APPLIED PRACTICES	MODEL MRR	3/19/10	
UNLESS OTHERWISE SPECIFIED DIMENSIONS ARE IN INCHES	DETAIL		TITLE
TOLERANCES ON:	CHECKED		2600A/3000A SERVICE ENTRANCE (3P-N1)
2 PL. DECIMALS ± .020	ENGRG YP	3/19/10	OUTLINE DRAWING
3 PL. DECIMALS ± .005	MFG		FIRST MADE FOR: ZTGSE30(3P-N1)
ANGLES ± 1°	QUALITY		SIZE CAGE CODE DWG NO
FRACTIONS ± 1/64	ISSUED		D 50C-4228
FINISH ✓	DRAWING FILE: 50c-4228-g-1		SCALE: NONE
AutoCad Generated	MODEL / ASSEMBLY FILE:		SHEET 1 of 1
# CTQs	CRITICAL TO QUALITY CHARACTERISTIC		