

DUAL DIMENSIONS INCHES (ESTIMATING ONLY)  
[MILLIMETERS]

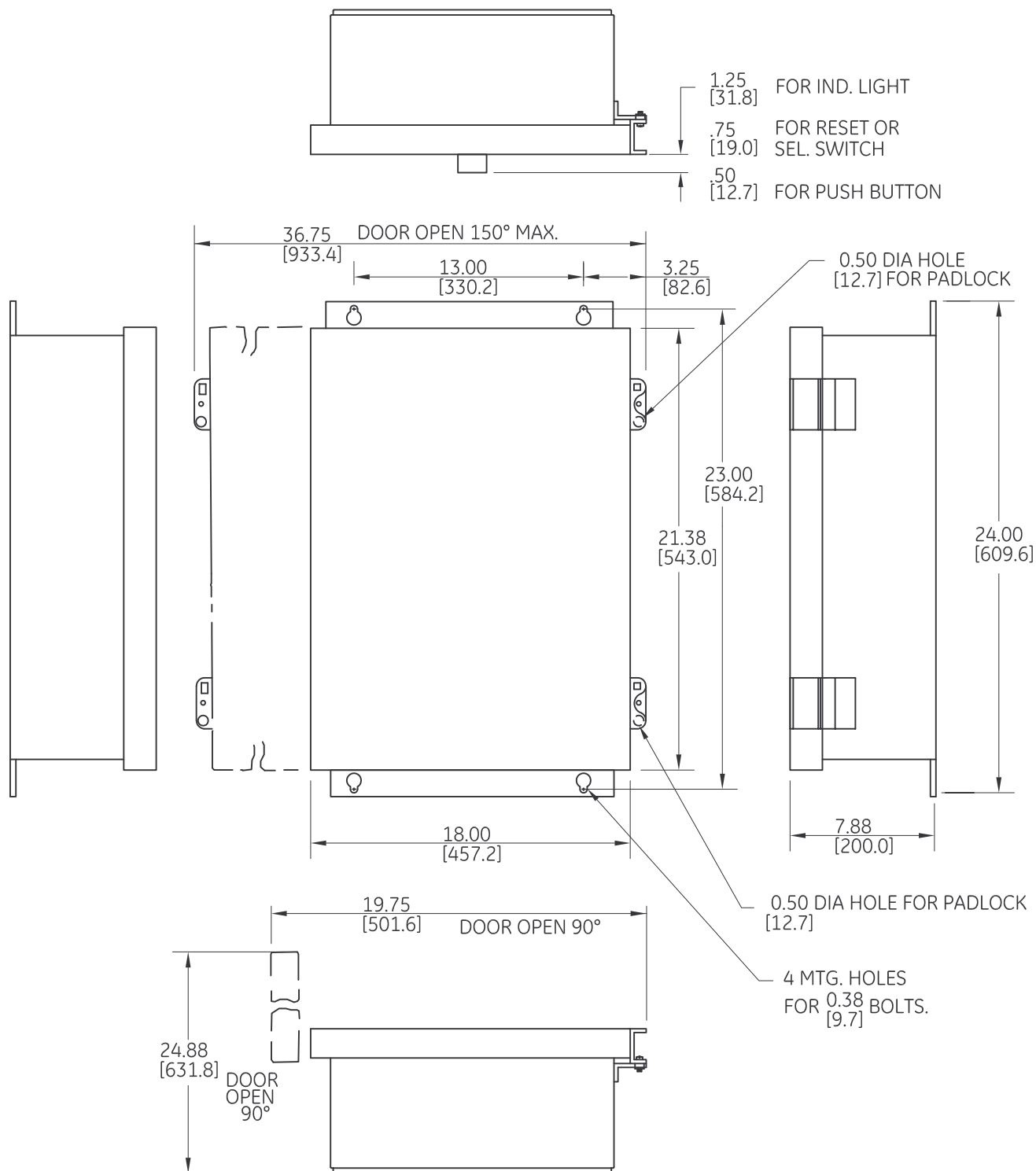

imagination at work

OUTLINE  
TYPE 12 ENCLOSED

AN #	THIRD ANGLE PROJECTION	SHEET #
09-9107		1 OF 1

DWG NO.	DATE	REV
55-200209	07/22/2009	1