

DUAL DIMENSIONS INCHES (ESTIMATING ONLY)
[MILLIMETERS]

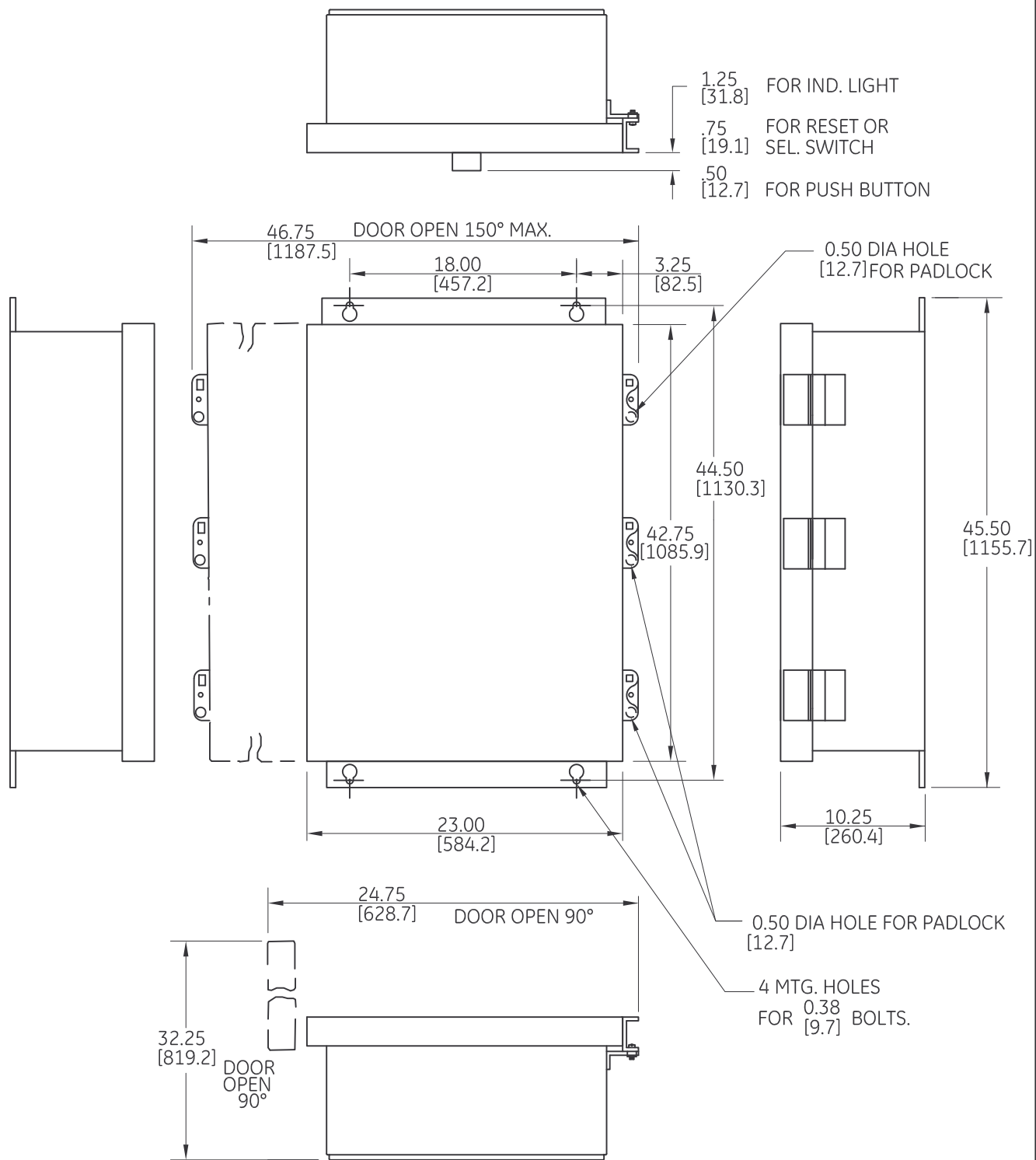

imagination at work

OUTLINE
TYPE 12 ENCLOSED

AN #	THIRD ANGLE PROJECTION	SHEET #
09-9107		1 OF 1

DWG NO.	DATE	REV
55-210569	07/22/2009	1