



Infinity S (NE-S) +24V/-48V or -48V/+24V System

NES2448-23-AC1-PS4-DC1E-LVBD

Primary/Secondary Voltage 23" wide AC input
AC1 = Molex # of Power Slots # of Distribution Panels (1 or 2) LVBD option
AC3 = IEC 320 C19



Read and follow all safety statements and precautions in this guide.
Controller: Pulsar Plus Controller is presented in this guide; see the Galaxy Millennium II Controller Users Guide for its installation details.
Refer to *Infinity S Power System Brochure* for details and accessories.

Tools required: Torque wrench (0-240 in-lb / 28 Nm) 5/16," 7/16" and 1/2" nut drivers
Cable crimpers Screw Drivers (#1 Flat & #2 Phillips) Wire cutters and strippers

Step 1 - Mount the System

Mount the system with a minimum gap of 3 inches behind the system to allow proper airflow.

1. Attach the system to the frame using a minimum of twelve (six on each side) 12-24 screws (provided).
Torque to 35 in-lb (7.3 Nm) - 5/16" socket.

Step 2 - Connect Chassis and DC Reference (CO) Ground

1. Connect Chassis Ground
Minimum 10 AWG recommended
Lug Landing - #10 on 5/8" centers (lug not provided).
Torque to 35 in-lb.
2. Connect DC reference ground
Lug Landing - 5/16" on 1" centers (lug not provided).
Torque to 160 in-lb.

Note: If connecting chassis ground to frame surface remove non-conductive frame coating and apply antioxidant for connection.

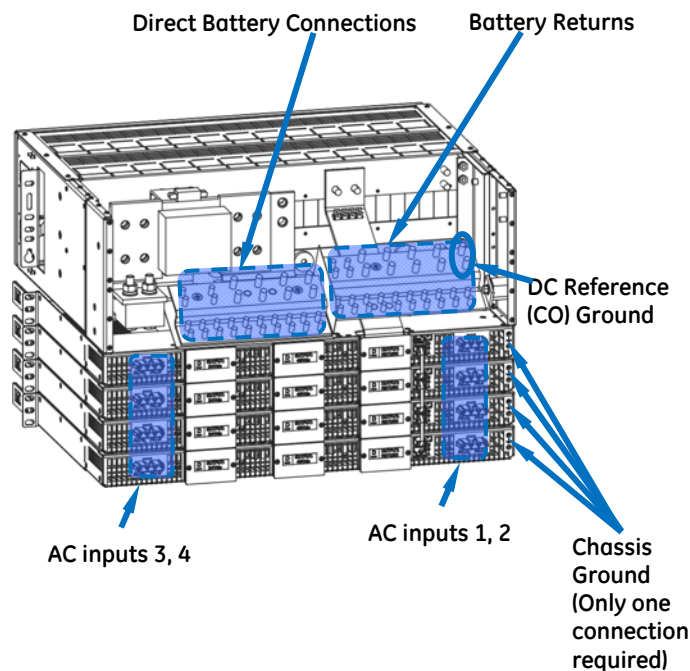

Step 3 - Connect AC Input

Connect 120/208/220VAC at rear of each rectifier shelf.

Danger: Turn OFF and lock-out tag-out the AC source before making AC connections. When connecting to AC mains, follow all local and national wiring rules.

Caution: When routing AC ensure cables do not come in contact with sharp or rough surfaces that may damage insulation and cause a short circuit.

Rectifiers numbers are labeled at each AC input. AC terminal connections are labeled at each position (L1, L2/N, and Gnd).

AC Input	Rectifiers per Feed	AWG max
AC1 - Molex mini-fit SR	2	8
AC3 - IEC-320 C19	1	12
AC5 - Terminal Block	1	10

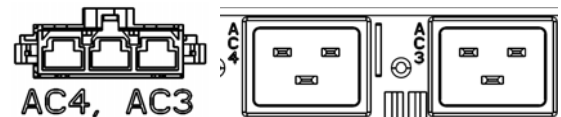

AC3 - IEC

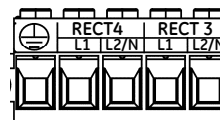

AC5 - TB

Step 4 - Connect Batteries and DC Output to Loads

The figure to the right shows the DC circuit of the system.

Battery connections are made to the battery bus.

Lug Landings: 3/8" on 1" centers (4)
1/4" on 5/8" centers (12)

CAUTION: Verify battery voltage and polarity with a voltmeter before connecting.

Load connections are made to bullet-style distribution positions.

Distribution panels are each equipped with 26 bullet-style distribution positions. Each position is selectable between primary and secondary load output.

Lug Landings: 1/4" on 5/8" centers

Breakers up to 250A, TPS fuses to 70A and GMT style fuses to 12A are available.

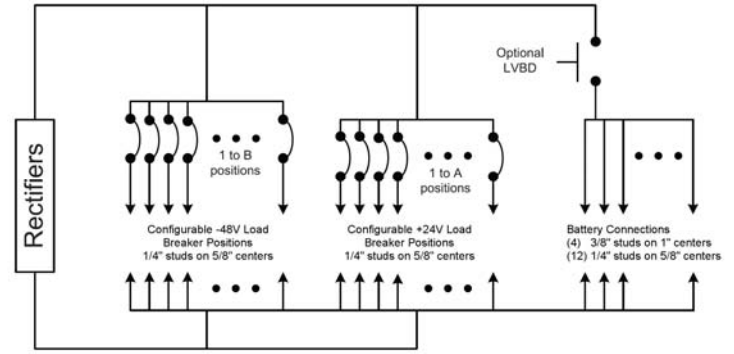

A + B = 26 each for distribution Panel

Lug Landings		
Landings	1/4-20 studs on 5/8" centers Lug tongue width 0.68" max	3/8-16 studs on 1" centers Lug tongue width 0.68" max
Torque	65 in-lb - 7/16" socket	240 in-lb - 9/16" socket



Move plastic slider for -48V or +24V (+24V shown)

Upper Breaker position for -48V load

Lower Breaker position for +24V load



Alarm Pin

Correct Breaker orientation for insertion

Two multi-pole adapters are required for each multi-pole breaker - figure below.

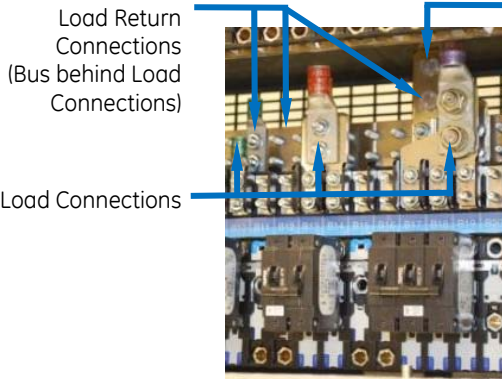

Return Bus Adapters Face lug studs to the rear.

Multi-Pole Adapter Kits - 2 required per breaker			
	CC848756916	850021775	850021955
Poles	2	2	3
Lug Landings	1/4" x 5/8"	3/8" x 1"	3/8" x 1"

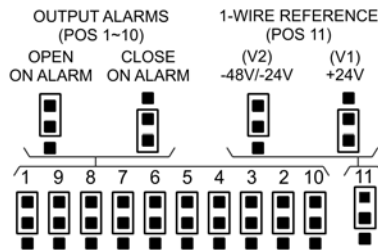

Alarm Relay Jumpers
Factory Defaults are Open On Alarm

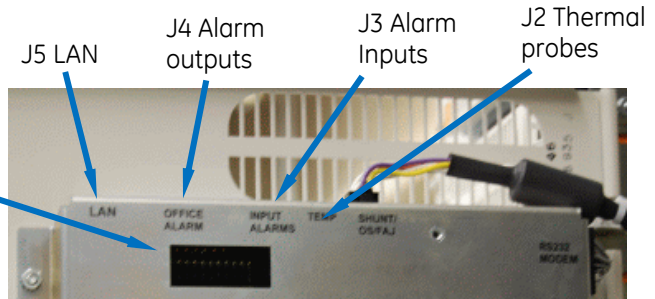

Controller Jumpers and Connections



Step 5 - Set Controller Jumpers

Pulsar Plus

1. Set jumpers 1 thru 10 for the ten alarm relays as Close on Alarm or Open on Alarm; Factory default setting is Open on Alarm.

Millennium II - See the Galaxy Millennium II Controller Users Guide for details.

Step 6 - Connect Controller Signals

1. Connect per site engineering instructions.

Pulsar Plus - Connect to J1, J2, J3, J4, and J5. See *Information Controller Connections*.

All controller connections are accessible on the left side of the controller, with the controller installed.

Millennium II - see Galaxy Millennium II Controller Users Guide for details.

Step 7 - Rectifier Installation

Slide the rectifier into the rectifier slot approximately 3/4 of the way.



Open the faceplate by sliding the faceplate latch to the left until the faceplate releases and swings outward.

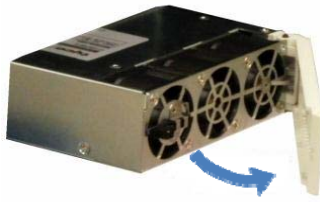

Slide the unit into the slot until it engages with the back of the shelf. Swing the faceplate closed to fully seat the rectifier. Verify the faceplate is latched.

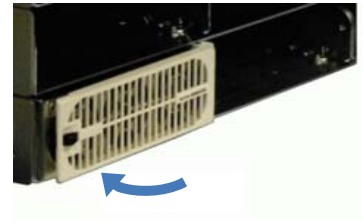

Step 8 - Initial Start Up

Verify that all AC, DC and Controller connections are complete and secure. Turn on AC input breakers. If there are no alarms, make required adjustments to the default settings on the controller for this installation.

Step 9 - Configure Controller

Verify and edit controller basic configuration parameters per site engineering instructions.

Pulsar Plus - per Galaxy Pulsar Plus Product Manual

Millennium II - per Galaxy Millennium II Controller Users Guide



Information: Controller Basic Operation

View and change system parameters from the factory defaults via

- A) Controller Display
- B) Craft Port on front of controller using a laptop with EasyView2 software or HyperTerminal.

EasyView2 (GUI) software can be downloaded from www.gecriticalpower.com.

- C) J5 LAN port web pages using a laptop with browser. LAN port Server mode is for local laptop connection. Set the LAN port to Server: With the controller set to Server enter the default IP address 192.168.2.1 (default) in the web browser address field.

Warning: Do not connect J5 LAN port to a network when set to Server. Set the controller to Client or Static before connecting to the network. Static is the factory default setting and the typical setting for most networks.

Controller Alarm Status: The display changes colors; Green = Normal, Amber = Minor Alarm, Red = Critical/Major Alarm

Some alarms may occur during initial installation; example: *thermal probe fail* or *Major/Minor communication fail*.

Clear these alarms: Via Controller Display: follow the menu path; *Menu > Control/Operation > Clear Events* or *Uninstall Equipment*.

Via web pages or EasyView2: Select the *Maintenance* tab > *clear latched events* and *clear missing devices*.

Verify Basic Installation Settings: Date, Time, Battery Type, number of strings and float voltage

Controller Display - *Menu > Configuration > System Settings* and *Menu > Configuration > Batteries*.

Web pages or EasyView2 - *Installation Tab* for Date, Time, Site ID and Site Description.

Settings Tab > Battery Management for Battery Type and number of battery strings installed.

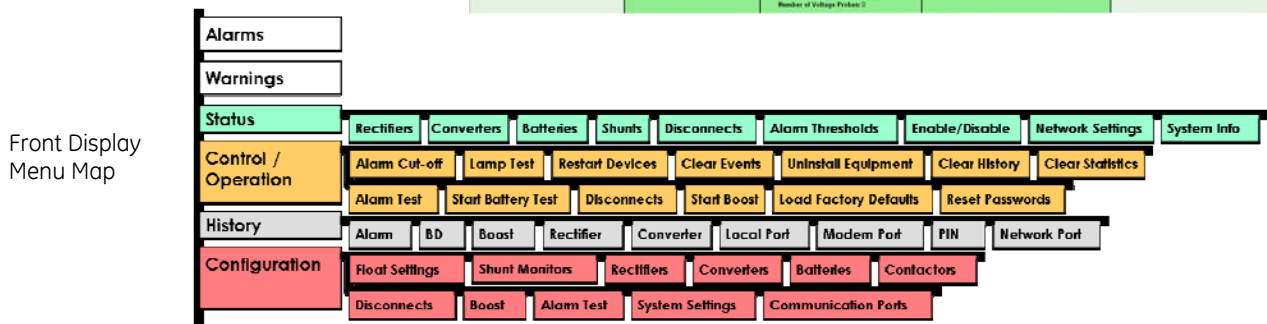
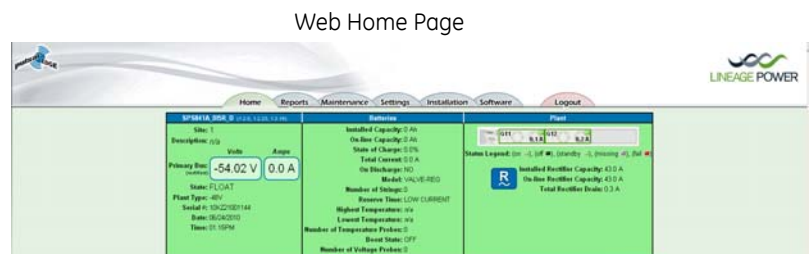
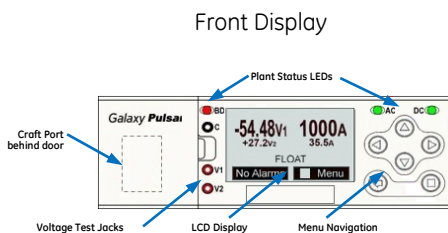

Information: Controller Default Voltage Settings and Ranges

Parameter	Range		Valve-Reg Default		Flooded		NiCd	
	-48V	+24V	-48V	+24V	-48V	+24V	-48V	+24V
Rectifier Float Selective High Voltage Shutdown	-50 to -60V	25 to 30V	58.50	29.25	58.50	29.25	58.50	29.25
High Float Voltage Major Alarm	-50 to -60V	25.74 to 31.75V	57.00	28.24	57.00	28.24	57.00	28.24
High Float Voltage Minor Alarm	-50 to -60V	24.75 to 29.75V	56.00	27.74	56.00	27.74	56.00	27.74
Rectifier/System Float Voltage	-42 to -56.5V	21 to 28V	54.48	27.24	52.08	26.04	54.40	27.20
Battery on Discharge Float Alarm	-46 to -55V	23 to 28V	51.00	25.54	50.00	25.54	51.00	25.54
Very Low Float Voltage Alarm	-40 to -51V	20 to 25.5V	46.00	23.00	46.00	23.00	46.00	23.00
Rectifier On Threshold	-40 to -51V	20 to 25.5V	44.00	22.00	44.00	22.00	44.00	22.00

Information: Battery Monitoring Connections

Battery Monitoring is accomplished with a "Daisy Chained" series of probes connected to J2. The Probes monitor battery temperature and voltage (ES771 required to monitor voltage). Bolt the Probe under the "-" terminal connector hardware; NOT under the connecting lug.

Max per system: Probes - 16, ES771 Modules - 6.

Battery Temperature Measurement

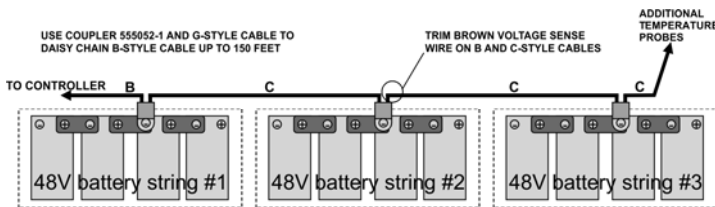

Ordering Codes	Descriptions
CC109142980	QS873A Battery Thermal Probe
150026698	QS873B Ambient Probe
CC848817024	B 10' controller to thermal probe wireset
CC109157434	B 20' controller to thermal probe wireset
CC848822560	C 1' thermal probe to thermal probe wireset
848719803	C 5' thermal probe to thermal probe wireset
CC848822321	C 10' thermal probe to thermal probe wireset
850037334	C 20' thermal probe to thermal probe wireset

Battery Temperature and Voltage Measurement

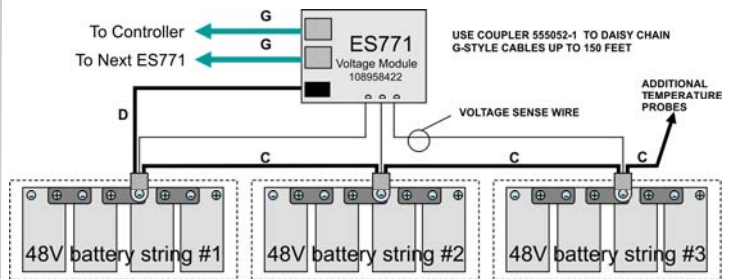

Ordering Codes	Descriptions
108958422	ES771A Voltage Monitor Card
CC848791517	D 2 1/2' ES771A to probe wireset
CC848797290	D 6' ES771A to probe wireset
848719829	D 10' ES771A to probe wireset
CC848791500	G 4' ES771A to ES771A or controller wireset
848652947	G 10' ES771A to ES771A or controller wireset

Information: AC Cord Options

IEC-Style 8ft, 12AWG		Molex mini-fit SR-Style No Plug	
CC848847368	No plug	CC848822420	(2) 15 ft., 3X8AWG
CC848850792	5-15P	848710711	(2) 10 ft., 3X8AWG
CC848850801	5-20P	CC848830522	(2) 4 ft., 3X8AWG
CC848850826	6-15P	CC848773515	15 ft., 10AWG SO Cord
CC848850834	6-20P	CC848906586	10 ft., 8AWG, SO Cord
CC848850842	L6-20P		



Information: Controller Connections

Alarm Outputs

Alarm relays are factory set to Open On Alarm. If Close On Alarm is desired adjust controller alarm jumpers. See diagram in step 5 for the location of the controller alarm jumpers. Connector J4 provides access to the primary customer alarm outputs. J4 is a 20-pin latching connector.

Standard Controller Alarm Output Defaults		Pin	Color Option 1	Color Option 2
PCR	Power Critical	1	BL	BL
PCR_C	Power Critical_C	11	W	BL/BK
PMJ	Power Major	2	O	O
PMJ_C	Power Major_C	12	W	O/BK
PMN	Power Minor	3	G	G
PMN_C	Power Minor_C	13	W	G/BK
R1	Battery On Discharge	4	BR	W
R1_C	Battery On Discharge_C (BD_C)	14	W	W/BK
R2	Very Low Voltage (VLV)	5	S	BK
R2_C	Very Low Voltage_C (VLV_C)	15	W	BK/W
R3	Fuse Alarm Major (FAJ)	6	BL	BL/W
R3_C	Fuse Alarm Major_C (FAJ_C)	16	R	BL/R
R4	AC Fail (ACF)	7	O	O/R
R4_C	AC Fail_C (ACF_C)	17	R	R
R5	Rectifier Fail (RFA)	8	G	G/W
R5_C	Rectifier Fail_C (RFA_C)	18	R	R/G
R6	Mult. Rectifier Fail (MRFA)	9	BR	W/R
R6_C	Mult. Rectifier Fail_C (MRFA_C)	19	R	R/W
R7	High Voltage (HV)	10	S	BK/R
R7_C	High Voltage_C (HV_C)	20	R	R/BK

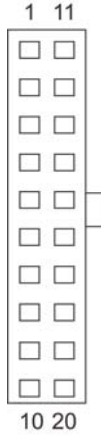

Alarm Inputs

Default alarm descriptions may be changed as needed using web pages or Easyview2. J3 is a 10-pin latching connector.



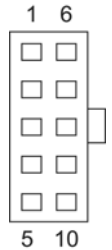

Standard Controller Alarm Input Defaults	J3 Pin	Color
Air Con Fail	1	BK
Air Con Fail_Return	8	V
Door Open	2	BR
Door Open_Return	8	V
Aux PMJ Input	3	R
Battery Test/GSTR	4	O
Battery Test_Return	9	S
EPO	5	Y
EPO_Return	10	W
Hi ext. Temp.	6	G
Hi ext. Temp_Return	8	V
Low ext. Temp.	7	BL
Low ext. Temp_Return	8	V



Alarm Output Cables		Alarm Input Cables	
CC848890137	5 ft.	CC848890153	5 ft.
CC109157442	15ft	CC848865980	15 ft.
CC848817635	50 ft	CC848817651	50 ft.
CC848817643	150 ft	CC848817668	150 ft.



Information: Rectifier Options

Rectifier		Input	Output DC		Recommended AC Breaker		
			Voltage	Current	AC1 (2 rectifiers per feed)	AC3	AC5
-48V Eco Rectifier  blue	NE050ECO48ATEZ	ac 208-240 Vac	48Vdc	50A	40A	20A	20A
		ac 110 Vac	48Vdc	22A	40A	20A	20A
		dc +/-30 to +/-150) Vdc, 11A max	48Vdc	50A		15A	15A
-48V Rectifier  blue	NE075AC48ATEZ	ac 208-240 Vac	48Vdc	75A/50A ¹	40A	20A	30A
		ac 110 Vac	48Vdc	25A	40A	20A	20A
	NE050AC48ATEZ	ac 208-240 Vac	48Vdc	50A	40A	20A	20A
		ac 110 Vac	48Vdc	22A	40A	20A	20A
	NE050AC48A	ac 208-240 Vac	48Vdc	50A	40A	20A	20A
+24V Rectifier  orange	NE100AC24ATEZ	ac 208-240 Vac	24Vdc	100A	40A	20A	20A
		ac 110 Vac	24Vdc	44A	40A	20A	20A
	NE100AC24A	ac 208-240 Vac	24Vdc	100A	40A	20A	20A
		ac 110 Vac	24Vdc	44A	40A	20A	20A
+24V Eco Rectifier  orange	NE100ECO24ATEZ	ac 208-240 Vac	24Vdc	100A	40A	20A	20A
		ac 110 Vac	24Vdc	44A	40A	20A	20A
		dc +/-30 to +/-150) Vdc, 11A max	24Vdc	100A		15A	15A

¹ 75A with AC5 and AC6, 50A with AC1 and AC3.

Specifications and Application

- Specifications and ordering information are in the *Infinity S Ordering Guide* available at www.gecriticalpower.com
- External Surge Protective Device (SPD) is required on all AC inputs.
- Equipment and subassembly ports:
 1. are suitable for connection to intra-building or unexposed wiring or cabling;
 2. can be connected to shielded intra-building cabling grounded at both ends.
- Grounding / Bonding Network – Connect to an Isolated Ground Plane (Isolated Bonding Network) or an Integrated Ground Plane (Mesh-Bonding Network or Common Bonding Network).
- Installation Environment - Install in Network Telecommunication Facilities, OSP, or where NEC applies.
- Battery return may be either Isolated DC return (DC-I) or Common DC return (DC-C).

Reference Documents

These documents are available at www.gecriticalpower.com.

Document	Title
CC848815341	Galaxy Pulsar Plus Product Manual
108994645	Galaxy Millennium II Controller Users Guide (aka Basic Installation and User's Guide for the Millennium II Controller)
	Infinity S Power System Brochure
CC848815325	Infinity NE Install Guide



Safety Statements

- Do not install this equipment over combustible surfaces.
- Rules and Regulations - Follow all national and local rules and regulations when making field connections.
- Compression Connectors
 - U. S. or Canada installations - use Listed/Certified compression connectors to terminate Listed/Certified field-wire conductors.
 - All installations - apply the appropriate connector to the correct size conductor as specified by the connector manufacturer, using only the connector manufacturer's recommended or approved tooling for that connector.
- Electrical Connection Securing: Torque to the values specified on labels or in the product documentation.
- Cable Dress - dress to avoid damage to the conductors and undue stress on the connectors.
- Circuit Breakers and Fuses
 - Use only those specified in the equipment ordering guide.
 - Size as required by the National Electric Code (NEC) and/or local codes.
Safety Tested Limits - Refer to the equipment ratings to assure current does not exceed:
Continuous Load (List 1) - 60% of protector rating
Maximum Load (List 2 - typically end of discharge) - 80% of protector rating.
 - GMT Style Fuses - Use only fuses provided with safety caps.
- Field-wired Conductors - Follow all National Electric Code (NEC) and local rules and regulations.
 - Insulation rating: 90°C minimum; 105°C (minimum) if internal to enclosed equipment cabinets.
 - Size AC field-wired conductors with 75°C ampacity (NEC) equal to or greater than their panel board circuit breaker rating.
- AC and DC input disconnect/protection - Provide accessible devices to remove input power in an emergency.
- Alarm Signals - Provide external current limiting protection. Rating 60V, 0.5A unless otherwise noted.
- Grounding - Connect the equipment chassis directly to ground. In enclosed equipment cabinets connect to the cabinet AC service ground bus. In huts, vaults, and central offices connect to the system bonding network.

Precautions

- Install, service, and operate equipment only by professional, skilled and qualified personnel who have the necessary knowledge and practical experience with electrical equipment and who understand the hazards that can arise when working on this type of equipment.
- Disconnect batteries from outputs and/or follow safety procedures while working on equipment. Batteries may be connected in parallel with the output of the rectifiers. Turning off the rectifiers will not necessarily remove power from the bus.
- Do not disconnect permanent bonding connections unless all power inputs are disconnected.
- Verify that equipment is properly safety earth grounded before connecting power. High leakage currents may be possible.
- Exercise care and follow all safety warnings and practices when servicing this equipment. Hazardous energy and voltages are present in the unit and on the interface cables that can shock or cause serious injury. When equipped with ringer modules, hazardous voltages will be present on the ringer output connectors.
- Use the following precautions in addition to proper job training and safety procedures:
 - Use only properly insulated tools.
 - Remove all metallic objects (key chains, glasses, rings, watches, or other jewelry).
 - Follow Lock Out Tag Out (LOTO) procedures: customer specified, site specific, or general as appropriate.
Disconnect all power input before servicing the equipment. Check for multiple power inputs.
 - Wear safety glasses.
 - Follow Personal Protective Equipment requirements: customer specified, site specific, or general as appropriate.
 - Test circuits before touching.
 - Be aware of potential hazards before servicing equipment.
 - Identify exposed hazardous electrical potentials on connectors, wiring, etc.
 - Avoid contacting circuits when removing or replacing covers;.
 - Use a personal ESD strap when accessing or removing electronic components.
- Personnel with electronic medical devices need to be aware that proximity to DC power and distribution systems, including batteries and cables, typically found in telecommunications utility rooms, can affect medical electronic devices, such as pacemakers. Effects decrease with distance.

