



Transformer



1M000000

Catalog Number

TYPE QL

9T62W9874G83

75.0 KVA 60 HZ 3 PH 2.6 % IMP

40 C AMB. 80 C RISE 220 C SYSTEM IS-19C

Note: Design is based on 150.0KVA & 150C Rise 5.5% Imp.

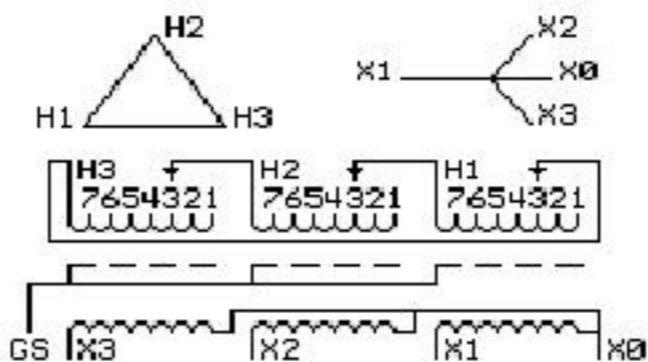

JUMPER CONNECTION TAP	VOLTS
1	506
2	491
3	480
4	470
5	454
6	444
7	433

NET WGT

1190 LB

539.8 Kg

9T40G00C7

43001

XV376

NOG

072715

INSPECTION & FINAL TEST N531!

PRIMARY (H) 480 VOLTS (LINE-LINE)
 SECONDARY (X) 208 VOLTS (LINE-LINE)
 120 VOLTS (LINE-NEUTRAL)

COIL TAP ARRANGEMENT

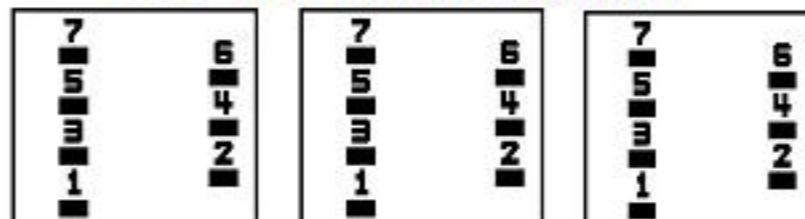

ELECTROSTATIC GROUND SHIELD IN EACH PHASE

ENCLOSURE TYPE 2 (IP30). RAINPROOF TYPE 3R ENCLOSURE (IP32) WHEN PROVIDED SHIELD 9T18W4317G07

SUITABLE FOR NONSINUSOIDAL CURRENT LOAD WITH K-FACTOR NOT TO EXCEED 20

BEFORE HANDLING, INSTALLING AND OPERATING, SEE INSTRUCTION 475A667AAP001

Outline: 303B401MWP076

COPPER CONDUCTOR

PRIMARY: 10 KV BIL

SECONDARY: 10 KV BIL

Assembled in Mexico

X3 - X2 - X1 - -
 - H3 - H2 - H1

Note: X0 Terminal at the bottom

IN ACCORDANCE WITH NEC SECTION 450-9, ALLOW AT LEAST SIX INCHES CLEARANCE FOR VENTILATION. CHECK ADDITIONAL NEC AND LOCAL CODES.

X3 - X2 - X1 -
 - H3 - H2 - H1
 X3 - X2 - X1 -
 - H3 - H2 - H1
 X0



2M000000

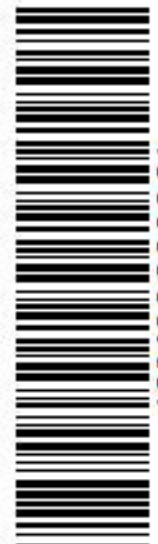

3M000000