



Transformer



1M000000

Catalog Number

TYPE QL

9T63W9872G83

30.0 KVA 60 HZ 3 PH 2.1 % IMP

40 C AMB. 80 C RISE 220 C SYSTEM IS-19C

Note: Design is based on 75.00KVA & 150C Rise 5.6% Imp.

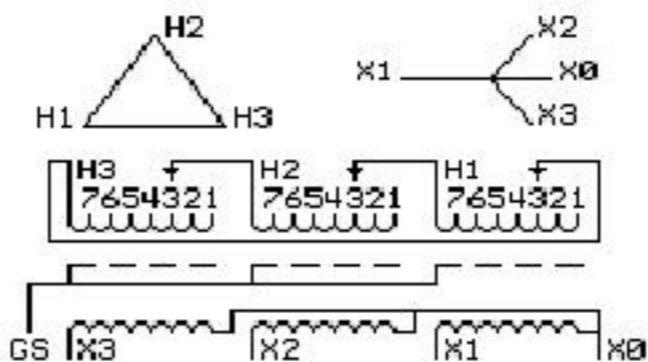

JUMPER CONNECTION	
TAP	VOLTS
1	503
2	492
3	480
4	469
5	458
6	443
7	432

NET WGT
710 LB
322.1 Kg
9T40G00C7
42965
XV374
NOG
081115

INSPECTION
&
FINAL TEST
N533!

PRIMARY (H) 480 VOLTS (LINE-LINE)
SECONDARY (X) 208 VOLTS (LINE-LINE)
120 VOLTS (LINE-NEUTRAL)

COIL TAP ARRANGEMENT

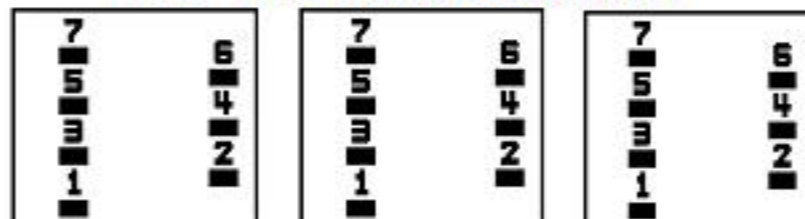

ELECTROSTATIC GROUND SHIELD IN EACH PHASE

ENCLOSURE TYPE 2 (IP30). RAINPROOF TYPE 3R ENCLOSURE (IP32) WHEN PROVIDED SHIELD 9T18W4317G06

SUITABLE FOR NONSINUSOIDAL CURRENT LOAD WITH K-FACTOR NOT TO EXCEED 30

BEFORE HANDLING, INSTALLING AND OPERATING, SEE INSTRUCTION 475A667AAP001

Outline: 303B401MWP074

COPPER CONDUCTOR

PRIMARY: 10 KV BIL

SECONDARY: 10 KV BIL

Assembled in Mexico

X3 - X2 - X1 - -
- H3 - H2 - H1

Note: X0 Terminal at the bottom

Midwest Electric Products

NEMA CLASS AA DRY TYPE TRANSFORMER

Meets TP-1 2002 efficiency



2M000000



3M000000

X3 - X2 - X1 - -
- H3 - H2 - H1
X3 - X2 - X1 - -
- H3 - H2 - H1
X0