



Transformer



M0000000

Catalog Number

Type QL

9T83B3892

30.0 KVA 60 HZ 3 PH 5.6 % IMP

40 C AMB. 150 C RISE 220 C SYSTEM IS-19C

PRIMARY (H) 600 VOLTS (LINE-LINE)
SECONDARY (X) 208 VOLTS (LINE-LINE)
120 VOLTS (LINE-NEUTRAL)

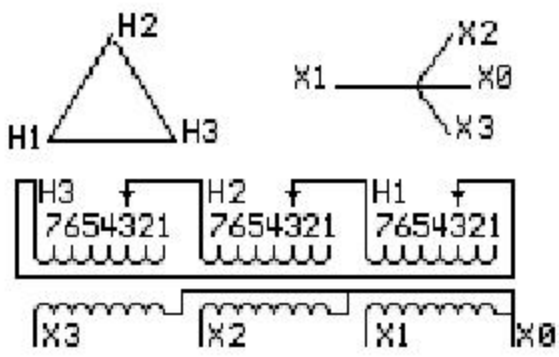

COIL TAP ARRANGEMENT

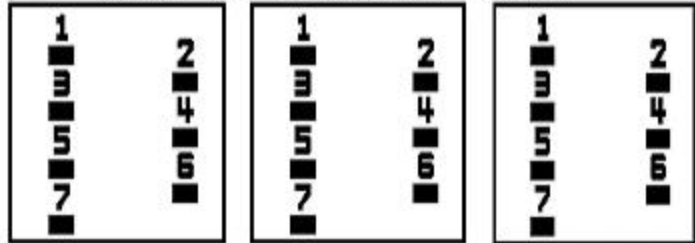

JUMPER CONNECTION	
TAP	VOLTS
1	630
2	614
3	600
4	585
5	571
6	555
7	539

NET WGT
334 LB
151.5 Kg
9T83B3892
26483
WU372
NOG
013013

INSPECTION
&
FINAL TEST
N305!



LISTED 769G

Assembled in Mexico

ENCLOSURE TYPE 2 (IP30). RAINPROOF TYPE 3R ENCLOSURE (IP32) WHEN PROVIDED SHIELD 9T18Y4317G05

BEFORE HANDLING, INSTALLING AND OPERATING, SEE INSTRUCTION 475A667AAP001 Outline: 303B401AAP072
ALUMINUM CONDUCTOR PRIMARY: 10 KV BIL SECONDARY: 10 KV BIL

IN ACCORDANCE WITH NEC SECTION 450-9, ALLOW AT LEAST SIX INCHES CLEARANCE FOR VENTILATION. CHECK ADDITIONAL NEC AND LOCAL CODES.

X3 - X2 - X1 - -
- H3 - H2 - H1

Note: X0 Terminal at the bottom

X3 - X2 - X1 - -
- H3 - H2 - H1
X3 - X2 - X1 - -
- H3 - H2 - H1

X0



M0000000



M0000000