



# K Factor Transformer



\*1M000000\*

Catalog Number TYPE QL

## 9T83C9462G03

30.0 KVA 60 HZ 3 PH 5.1 % IMP

40 C AMB. 150 C RISE 220 C SYSTEM IS-19C

Note: Design is based on 30.00KVA & 150C Rise 5.1% Imp.

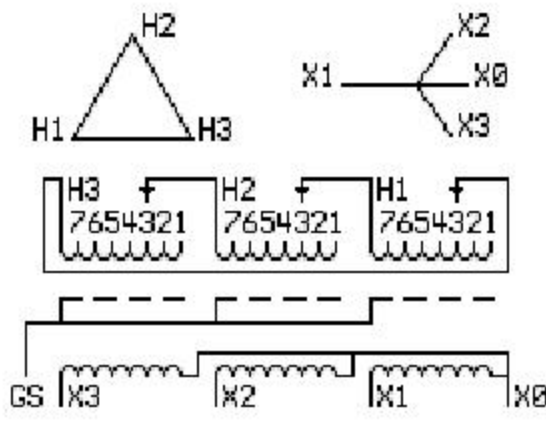

JUMPER CONNECTION TAP	VOLTS
1	504
2	492
3	480
4	468
5	456
6	444
7	432

NET WGT  
435 LB  
197.3 Kg  
9T83C7872G0  
11942  
EE72  
NOG  
111411

INSPECTION & FINAL TEST  
N147!

PRIMARY (H) 480 VOLTS (LINE-LINE)  
SECONDARY (X) 208 VOLTS (LINE-LINE)  
120 VOLTS (LINE-NEUTRAL)

### COIL TAP ARRANGEMENT

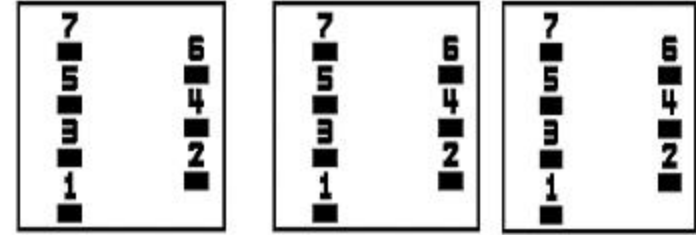

ELECTROSTATIC GROUND SHIELD IN EACH PHASE

ENCLOSURE TYPE 2 (IP30). RAINPROOF TYPE 3R ENCLOSURE (IP32) WHEN PROVIDED SHIELD 9T18Y4317G05

SUITABLE FOR NONSINUSOIDAL CURRENT LOAD WITH K-FACTOR NOT TO EXCEED 4  
BEFORE HANDLING, INSTALLING AND OPERATING, SEE INSTRUCTION 475A667AAP001 Outline: 303B401AAP072  
COPPER CONDUCTOR PRIMARY: 10 KV BIL SECONDARY: 10 KV BIL

IN ACCORDANCE WITH NEC SECTION 450-9, ALLOW AT LEAST SIX INCHES CLEARANCE FOR VENTILATION. CHECK ADDITIONAL NEC AND LOCAL CODES.

Assembled in Mexico

X3 - X2 - X1 - -  
- H3 - H2 - H1

Note: X0 Terminal at the bottom

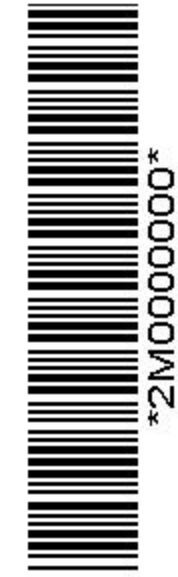
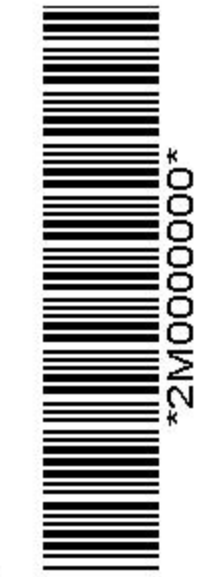

X3 - X2 - X1 - -  
- H3 - H2 - H1  
X3 - X2 - X1 - -  
- H3 - H2 - H1

X0