

GE Overcurrent Device Instantaneous Selectivity Tables

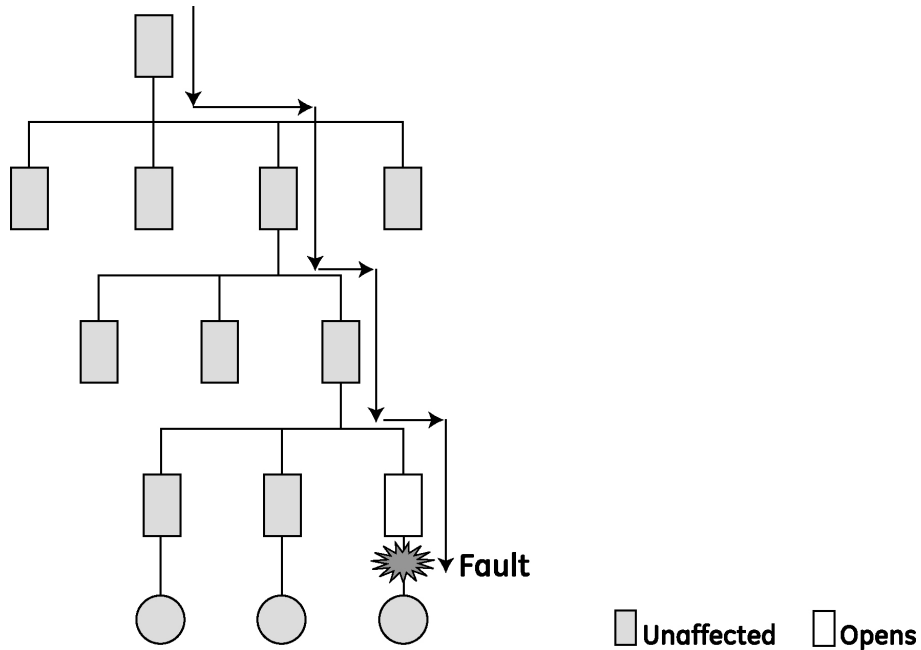

Contents

Introduction	3
Selectivity with EntelliGuard TU and <i>micro</i>EntelliGuard	
EntelliGuard TU Trip Units in ANSI and ICCB / Power Break II Circuit Breakers	9
EntelliGuard TU Trip Units in ANSI WavePro Circuit Breakers	12
Instantaneous ZSI on EntelliGuard TU Trip Units in ANSI Entelliguard G Circuit Breakers	13
Instantaneous ZSI on EntelliGuard TU Trip Units in UL489 Entelliguard G Circuit Breakers	15
Instantaneous ZSI on Spectra <i>micro</i> EntelliGuard Circuit Breakers ...	17
Typical Switchboard / Power Panels Combinations	19
<u>Upstream (Mains)</u>	
Stored Energy Mains	
ABB S7	
Record Plus FG	
<u>Downstream (Feeders)</u>	
ABB S7	
Record Plus FG & FE	
Spectra SE & SF	
Typical Lighting Panel Combinations	20
<u>Upstream (Mains)</u>	
Stored Energy Main	
ABB S7	
Record Plus FG & FE	
<u>Downstream (Feeders)</u>	
Record Plus FB	
TEY & TEYF	
THQB & THHQB	

Upstream (Mains) Stored Energy Mains

Downstream (Feeders)

Electronic Trip MCCBs

Spectra RMS

Thermal Magnetic MCCBs

ANSI/ICCB	22
SK	24
SG	25
Spectra Circuit Breakers	26
Record Plus Circuit Breakers.....	27
THK, TK.....	28
TJ, THF, TF.....	29
Lighting Panel Circuit Breakers	30
MCPs with Current Limiters.....	29
Spectra with MVT Trip	32
SK	34
SG	35
SF.....	36
SE.....	37
THJK, TJK, TJJ, TJD	38
THFK, TFK, TFJ	40
THQD, TQD	41
TEY	42
THHQB, THQB	43
Record Plus FB	44
TECL	45
Record Plus FG	46
SK	47
SG	48
SF.....	49
SE.....	51
TEY	53
THHQB, THQB	55
TECL	57
THQD, TQD	59
TEY & THHQB, THQB	60
THQB, TEY, FB	62

GE Overcurrent Device Instantaneous Selectivity Tables

The following tables list the instantaneous selectivity capability of various GE circuit breakers. In many cases, selectivity may exceed the selectivity determined by traditional time-current curve analysis. The traditional time-current curves, plotted in Figure 1, demonstrate that the 100A and 1600A circuit breakers shown are fully selective up to ~21,500A RMS. However, other analytical techniques and high current testing have demonstrated that these two circuit breakers are selective to a much higher value, at least 39,600A. The higher values available with many overcurrent devices will be shown on the tables in this reference publication, as well as some values determined by traditional curve overlay.

How tables are derived:

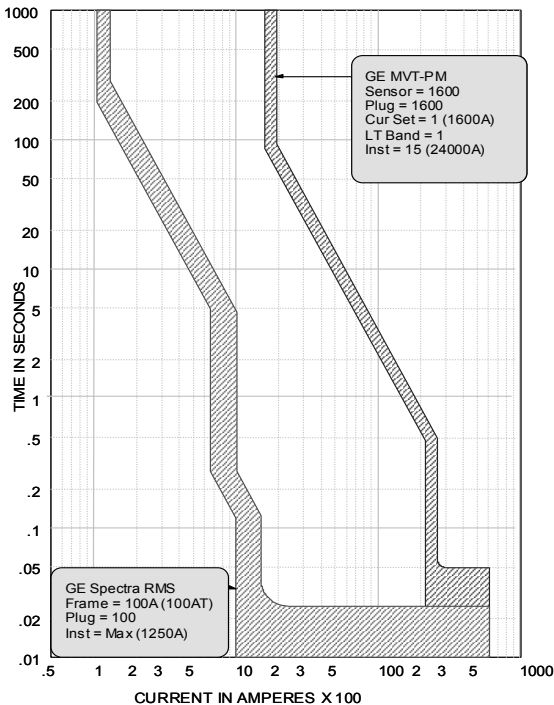

Figure 1

Circuit breaker mechanisms employ multiple means to open and latch contacts. Some of the mechanisms are very sensitive to instantaneous peak currents. Other mechanisms may be more sensitive to energy, rate of change of the current, etc. Some may take into account waveform shape over more than one half cycle and many use combinations of these mechanisms. The different operating mechanisms used and their respective interactions must be considered when analyzing system selectivity. Traditional time-current curve based coordination studies provide a very conservative analytical method for determining selectivity and ignore the impact of the various circuit breaker operating mechanism designs.

The selectivity tables in this publication were derived through rigorous analytical techniques, extensive testing and Six Sigma methodology. The testing was performed using a protocol similar to that described in UL 489 (Standard for Molded Case Circuit Breakers) for series ratings. Testing and analysis was performed for a range of fault magnitudes, closing angles and X/R ratios.

Assumptions:

- Fault values are expressed in 60 Hz RMS.
- Selectivity short circuit values are valid at the voltage described and any lower voltage. Selectivity at voltages in excess of those specifically noted is not implied in these tables.
- Selectivity values for paired circuit breakers are valid for X/R ratios equal to, or less, than those for which the OCPDs were tested or analyzed. A fault X/R ratio higher than the test X/R ratio will require that the selectivity be de-rated by the ratio of the prospective peak currents. A table of X/R ratios, Power Factors and expected peak currents is provided. These de-rating methods are the same as those used to de-rate the interrupting rating of any overcurrent protection device whose test X/R ratio is less than the X/R ratio of the available fault current where the device is applied.



- For devices equipped with EntelliGuard TU trip units, selectivity is determined by the adjustable instantaneous overcurrent (IOC) settings on the trip unit. The table on page 9 illustrates selectivity levels possible using EntelliGuard TU trip units. The tables on pages 12-18 further illustrate enhanced selectivity possible using the EntelliGuard family's Instantaneous Zone Selective Interlocking (I-ZSI) capabilities.
- For devices not equipped with EntelliGuard family trip units, the instantaneous selectivity is based on the upstream and downstream circuit breaker IOC being set at the highest possible setting. Where the downstream circuit breaker has an adjustable trip, the setting may be adjusted lower without adverse impact on selectivity. Unless otherwise indicated, the upstream breaker IOC setting must remain at maximum to achieve the listed selectivity.

Considerations and cautionary notes regarding implementation of instantaneous selectivity

Most industry standards, and good engineering practice, indicate that selectivity is desirable in most power distribution systems to maximize system reliability. However, system designers must weigh selectivity needs against other important system considerations, such as safety, operational reliability, feasibility, efficiency, cost and size. The National Electrical Code defines minimum performance requirements for construction. Designers should consider other factors that may or may not be addressed by the NEC. They should be aware that systems designed for high levels of selectivity may lead to higher arc flash energy, reduced operator and maintenance safety, higher installation costs and larger equipment or conductors. Although the use of I-ZSI and lower Instantaneous Pick-Up settings, through features such as a Maintenance Mode or RELT (Reduced Energy Let-Thru), help balance the compromises between arc flash risk and selectivity, the consequences of these risks should be understood.

Traditional time-current curve based analysis must still be used to make sure that long time, short time phase overcurrent and ground fault protection devices are selectively coordinated. These tables provide additional guidance on application of OPD selectivity where the

instantaneous clearing times shown on traditional-time-current curves overlap.

Breaker operation can also be caused by, but not limited to: over-voltage, under-voltage, current-imbalance, phase loss, and excessive stray voltages. Over time, unusual system conditions such as component degradation, significant load changes and changes in environmental conditions may also adversely affect system reliability. Some of these considerations can be improved by good system design, environmental control and sound maintenance practices.

How to Use the Tables

How to find and read values

Before using these tables, the user must have the system one-line diagram, complete with system voltages and available fault currents. The capability for instantaneous selectivity of a particular circuit breaker may be dependent on the trip setting, the trip plug, the circuit breaker's sensor or the circuit breaker's frame size. The tables will indicate which parameter in the device drives its selective capability.

The table on page 9 (for devices equipped with the EntelliGuard TU trip unit) is organized with upstream devices across the top of the tables (in **boldface type**), and downstream devices in columns on the left, in *italics*. The column titled "EntelliGuard TU Instantaneous Setting Must Be Greater Than" shows the minimum Instantaneous pickup setting (on the upstream device) that will provide the selectivity shown (above the corresponding downstream device). The table on page 10 illustrates the maximum possible pickup settings for typical upstream devices equipped with the EntelliGuard TU trip unit.

The tables on pages 12-18 are also arranged with upstream devices across the tops of the tables and downstream devices in columns. The intersection of a row and column define the maximum possible selectivity of that pair of devices using Instantaneous Zone Selective Interlocking (I-ZSI).

The remaining tables are organized with upstream devices (mains) in columns on the left (in **boldface type**) and downstream devices (feeders)



at the right (in *italics*). The value at the intersection of a row and column defines the maximum instantaneous current selectivity capability of the paired devices. Where a "TCC" is shown in the table in place of an actual value, some instantaneous selectivity may be possible with a slight adjustment of the downstream device. Where "NIS" is shown, the devices are too close in size and will probably overlap in the short time or overload range, resulting in limited or no selectivity.

Often selectivity may be improved by using a larger frame upstream device or a circuit breaker with greater adjustability. Downstream selectivity may be improved by using a device with greater current limiting characteristics.

Systems with more than two circuit breakers

The analysis used to produce the tables allows three or more devices to be combined. Figure 2 represents a system composed of three circuit breakers defined as devices A, B and C. The devices are applied at three different fault current values. Circuit breaker A and circuit breaker B need to be selective up to 30kA, circuit breaker B and circuit breaker C need to be selective up to 13kA. If these two requirements are fulfilled then circuit breakers A and C will also be selective. Note that the fault current value at the first circuit breaker is important to determine the short circuit rating required for that device, however it is the fault value at the downstream circuit breaker that determines the selectivity need.

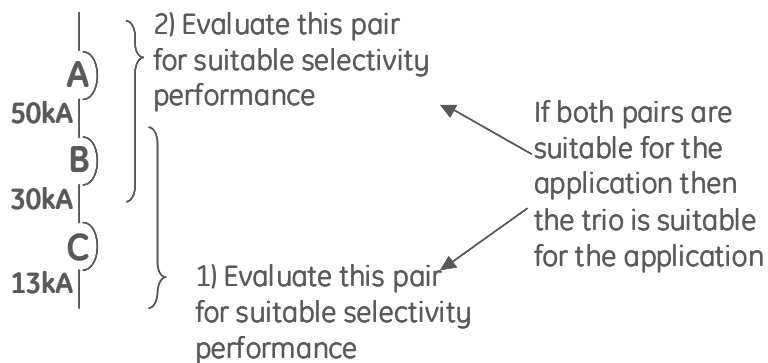

Figure 2
Multiple Circuit Breaker Selectivity

Through transformer selectivity

Breakers serving a transformer primary and secondary are an example of a circuit where all overcurrent devices do not need to be completely selective to assure reliable system selectivity. Figure 3 shows a simplified system with panel main, a transformer primary feeder fed from that bus, a 75kVA transformer, a 250A secondary main and some 120/208V circuits in the downstream panel.

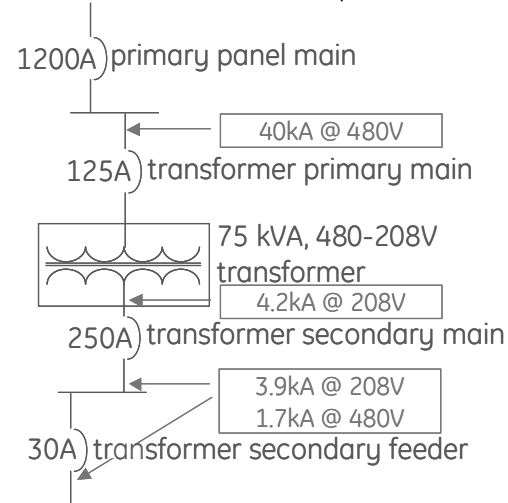

Figure 3
Through Transformer Selectivity

For the example shown in Figure 3, the 125A transformer primary main should be selective with the 1200A panel main. Selectivity would be required up to fault current value at the 125A device, or 40kAIC (kA Interrupting Current). The 125A primary main and the 250A secondary main need not be selective with each other. Loss of either device has the same effect on power continuity at the secondary loads. However, the 250A secondary main needs to be selective with the 1200A primary panel main for the maximum available secondary fault current. The secondary fault current is limited by the transformer impedance. The secondary fault current as seen by the primary circuit is further limited by the transformer ratio. In this example, the calculated, bolted three-phase fault current at the transformer's secondary terminals is 4.2kAIC. At the secondary panel, the fault current is 3.9kAIC due to the secondary cable impedance. Selectivity between the 30A feeder and the 250A secondary



main is required. A maximum fault current of 3.9kA below the secondary feeder defines the selectivity requirement for that pair of devices. For a 480/208V, delta - wye transformer, the transformer ratio is 2.31:1. The 3.9kA available fault current divided by the transformer ratio is (3.9kA/2.31) 1.7kA. Hence, the 30A secondary feeder and the transformer primary main only need to be selective to 1.7kAIC.

Accounting for X/R ratios greater than test ratios

Circuit breakers are tested at different X/R ratios depending on RMS value of the test currents. The following are the test currents and power factors used on UL 489 testing, and the corresponding X/R-ratios, and the Peak to RMS current ratios. These are the same values used for the selectivity tables.

- < 10,000A RMS – PF=50%; X/R=1.732, Peak/RMS =1.694
- >10,000 – 20,000A RMS – PF=30%; X/R=3.180, Peak/RMS = 1.978
- >20,000A RMS – PF=20%; X/R=4.899, Peak/RMS = 2.183

A fault current of 60,000A at an X/R ratio of 7 exceeds the standard X/R value. Because of this, the actual peak current magnitude is larger than it would be for an X/R of 4.899. For selectivity analysis purposes, the current should be adjusted as follows:

- $60,000A \times (2.336/2.183) \sim 64,200A$

Where:

- 60,000 = base RMS fault current value.
- 7 = X/R ratio of the calculated fault current.
- 2.183 = peak current factor for a fault current with an X/R ratio of 4.9 (from Chart 1).
- 2.336 = peak current factor for a fault current with an X/R ratio of 7 (from Chart 1).

Test Ranges	Power Factor	X/R ratio	Maximum Peak
	4	24.9790	2.663
	5	19.9740	2.625
	6	16.6230	2.589
	7	14.2510	2.554
	8	12.4600	2.520
	8.5	11.7230	2.504
	9	11.0660	2.487
	10	9.9501	2.455
	11	9.0354	2.424
	12	8.2733	2.394
	13	7.6271	2.364
	14	7.0721	2.336
	15	6.5912	2.309
	16	6.1695	2.282
	17	5.7967	2.256
	18	5.4649	2.231
	19	5.1672	2.207
>20kA	20	4.8990	2.183
	21	4.6557	2.160
	22	4.4341	2.138
	23	4.2313	2.110
	24	4.0450	2.095
	25	3.8730	2.074
	26	3.7138	2.054
	27	3.5661	2.034
	28	3.4286	2.015
	29	3.3001	1.996
≤20kA, >10kA	30	3.1798	1.978
	31	3.0669	1.960
	32	2.9608	1.943
	33	2.8606	1.926
	34	2.7660	1.910
	35	2.6764	1.894
	36	2.5916	1.878
	37	2.5109	1.863
	38	2.4341	1.848
	39	2.3611	1.833
	40	2.2913	1.819
	41	2.2246	1.805
	42	2.1608	1.791
	43	2.0996	1.778
	44	2.0409	1.765
	45	1.9845	1.753
	46	1.9303	1.740
	47	1.8780	1.728
	48	1.8277	1.716
	49	1.7791	1.705
≤10kA	50	1.7321	1.694

Chart 1



Circuit breaker types

GE offers several types of circuit breakers with different adjustment and selectivity capabilities. They may be broadly described as follows.

GE MVT, EntelliGuard TU trip unit and Spectra RMS trips allow instantaneous trip to be adjusted as multiples of the trip plug rating. The maximum adjustment may be limited by the frame. In the GE Record Plus, ABB S7 and GE Spectra *micro*EntelliGuard, the instantaneous trip is adjusted as a multiple of the current sensor.

ANSI and ICCB circuit breakers with fully adjustable trips

GE ANSI circuit breakers are those based on ANSI C37 standards. GE ANSI devices are sold as AKR, WavePro®, EntelliGuard® and EntelliGuard G ANSI circuit breakers. They are generically called Low Voltage Power Circuit Breakers (LVPCBs), and are listed to UL 1066.

These breakers are available with or without instantaneous trip functions. Some EntelliGuard G ANSI circuit breakers also have an Instantaneous override trip at very high values of fault current (85kA or 100kA depending on frame). Configured without instantaneous trips, these breakers are fully selective with downstream circuit breakers up to their short circuit withstand ratings.

When the instantaneous trip is omitted from an upstream main, selectivity is determined by trip current curves and may be as high as the short circuit withstand rating of the upstream circuit breaker in the pair. Therefore, Low Voltage Power Circuit Breakers – other than EntelliGuard G ANSI without an instantaneous trip – are included only in the table on page 19, as they are always capable of being selective up to their short circuit rating.

GE Insulated Case Circuit Breakers (ICCBs) are listed to UL 489. The ICCBs listed in these tables are Power Break II. The tables on pages 9-10 include Power Break II with EntelliGuard TU trip units. The GE ICCBs listed in the tables on pages 19-31 are GE Power Break® II™ with MicroVersaTrip™ trip units.

Power Break II circuit breakers with MicroVersaTrip are available with LSI or LI protection, “S” indicating the ability to set a short time pickup and delay. Power Break IIs with EntelliGuard TU trips always include LSI functionality, although a user may choose to not implement the S function.

Typically, any circuit breaker with short time pickup and delay allows for a higher instantaneous pickup adjustment. A higher instantaneous pickup may facilitate higher levels of instantaneous selectivity. Hence, all ANSI and ICCB circuit breakers using MicroVersaTrip or Entellisys systems have similar selectivity with regard to the settings available on their trip units.

Instantaneous Zone Selective Interlocking (I-ZSI)

Unique to the EntelliGuard TU trip unit is the ability to allow simultaneous and independent ZSI of both the short-time and instantaneous protection functions. Instantaneous protection may be interlocked such that all upstream circuit breakers whose zone includes the fault will shift from instantaneous clearing to a 0.058 second time band (in the case of EntelliGuard G circuit breakers) or 0.067 seconds (for older stored energy circuit breakers, such as WavePro or AKR). Since it is expected that faults of sufficient magnitude to engage the instantaneous pickup are dangerously high, all ZSI instantaneous trips that receive a restraint signal are shifted to the same band. So, if the bottom circuit breaker fails to clear, for whatever reason, quick backup protection from both or all upstream devices are provided.

Power Break II ICCBs and Spectra *micro*EntelliGuard MCCBs are capable of sending I-ZSI restraint signals, but cannot be restrained by a received signal. They must, therefore, be the most downstream breakers in a I-ZSI coordinated set of devices.

The ability to shift instantaneous protections allows these circuit breakers to be selective up to their full withstand rating while still providing instantaneous protection.



Molded Case Circuit Breakers (MCCB)

GE MCCB (Molded Case Circuit Breakers) fall into several categories:

Thermal magnetic

- Current limiting (GE Record Plus™, FC and FB families)
- Non-current limiting* (GE THQB, TEY, TE, TF, TJ, TK families and related frames)

Electronic trip

- Current limiting, adjustable instantaneous pick-up (I PU) only (GE Spectra frames E through G and Record Plus G)
- Non-current limiting*, adjustable I PU only (GE Spectra K frame)
- Current limiting, fully adjustable trips (GE Spectra G frame)
- Non-current limiting*, fully adjustable trips (GE Spectra K frame and ABB S7)

*Many MCCBs not labeled as current limiting may be current limiting under some fault conditions. It cannot be assumed that any CB not labeled current limiting “always” takes any specific amount of time to clear. Time current curves may show clearing times in excess of 1/2 or 1 cycle, however, the circuit breaker may interrupt in less than 1/2 cycle.

Fully adjustable electronic trips allow setting of the long time pick-up, long time delay, short time pick-up, short time delay and whether the short time characteristic will have an I squared T response or not. These electronic trips allow for separate adjustments of instantaneous and ground fault protection.

Current limiting circuit breakers as load side devices will provide greater levels of selectivity if the current limiting molded case circuit breaker downstream has a current limiting threshold lower than the instantaneous pick-up setting of the circuit breaker above.

Trip Unit Types

Product Family	Molded case	Insulated Case	ANSI	Trip Types Available		Protection Options (3)	
				Thermal-Magnetic (T/M) OR Electronic	Adjustable LSIG (2)	RELT	I - ZSI
Spectra (SE, SF, SG, SK)	Y	-	-	Spectra RMS – Electronic (1)	Optional <i>micro</i> EntelliGuard (SG and SK only) (5)	Y	Y
Record Plus (FB, FC, FE, FG)	Y	-	-	FB, FC – T / M	N/A	N	N
				FE, FG – Electronic	Optional – SMR2 (FG Only)	N	N
ABB S7 Isomax	Y	-	-	Electronic	PR211 (LI)	N	N
					Optional – PR212 (LSI or LSIG)	N	N
PowerBreak II	-	Y	-	Electronic	EntelliGuard TU (4)	Y	Y
WavePro	-	-	Y	Electronic	EntelliGuard TU (4)	Y	Y
EntelliGuard G	-	Y	Y	Electronic	EntelliGuard TU	Y	Y

1 Spectra RMS breakers are electronic sensing, make use of rating plugs, and allow adjustment of Only Instantaneous Pickup.

2 User to define the trip unit configuration (LS, LSI, LSIG) prior to order.

3 Protection options available via the EntelliGuard TU trip unit family. For additional options such as over/ under voltage, please consult the individual application guides for each device.

4 Legacy trip units on these devices include MicroVersaTrip Plus (MVT+) and PM (MVT PM) models. Selectivity ratings for devices with these legacy trips are included throughout this publication for reference. Please note: Legacy trips cannot be equipped with RELT or I-ZSI; EntelliGuard TU Trip Unit retrofit kits are available for Advanced Protection Options.

5 Legacy trip units on SG and SK include MicroVersaTrip Plus (MVT+) and PM (MVT PM) models. Selectivity ratings for devices with these legacy trips are included throughout this publication for reference. Please note: Legacy trips cannot be equipped with RELT or I-ZSI.



EntelliGuard TU Trip Units in ANSI and ICCB/Power Break II Circuit Breakers

Selectivity with EntelliGuard TU Trip Units in ANSI and ICCB / Power Break II Circuit Breakers

Selectivity between any upstream circuit breaker with an EntelliGuard TU trip unit and a downstream GE current limiting circuit breaker is determined by the setting of the upstream EntelliGuard TU. The table below identifies the values for GE's currently produced UL listed current limiting molded case circuit breakers. When the upstream trip unit's IOC is set at the value listed in the column labeled "EntelliGuard TU instantaneous setting must be \geq " or higher, the pair is selective over the instantaneous range. The table describes how the circuit breaker type limits selectivity. The table applies at 208 through 480 volts, except where limited by circuit breaker maximum voltage.

Downstream		Upstream				
Frame Designation	Maximum Trip (frame or sensor)	(3) EntelliGuard TU instantaneous setting must be \geq	Power Break II, UL 489 CB	WavePro, AKR or AK, or other ANSI CB without a mechanical override	EntelliGuard G, UL489 CB	EntelliGuard G, ANSI CB
<i>Record Plus G</i>	600A	20,360A	Up to short circuit rating; 65kA, 100kA or 150kA at 480V, and 200kA at 240V (4)	Up to short circuit rating; 65kA, 100kA or 150kA at 480V (4)	Up to withstand rating; 42kA, 50kA, 65kA, 85kA or 100kA at 480V (4)	Up to withstand rating; 65kA, 85kA or 100kA at 480V (4)
	400A					
	250A					
<i>Record Plus E</i>	250A	9,610A(1)				
	150A					
	100A					
	60A					
<i>Record Plus B/C</i>	100A	7,110A				
	600A	29,990A				
<i>Spectra G</i>	400A					
250A						
<i>Spectra F</i>	250A	11,210A(2)				
<i>Spectra E</i>	150A	9,610A(2)				
TECL	3 & 7A	800A(1)				
	15A	850A(1)				
	30A	1,800A(1)				
	50A	3,800A(1)				
	100A	7,300A(1)				
TEY/TEYF	15-100A	9,610A(1)	14,000A	14,000A	14,000A	14,000A
	THQL (240V)	15-60A	9,610A(1)	10,000A	10,000A	10,000A
THHQL (240V)	15-60A	9,610A(1)	22,000A	22,000A	22,000A	22,000A

1 EntelliGuard TU must employ a 400A rating plug or larger

2 EntelliGuard TU must employ an 800A rating plug or larger

3 Any instantaneous overlap seen in time current curves when line side CB is set per table does not indicate a lack of selectivity and may be ignored.

4 Selectivity rating cannot exceed the short circuit rating of the downstream device.



EntelliGuard TU Trip Units in ANSI and ICCB/Power Break II Circuit Breakers

Selectivity with EntelliGuard TU Trip Units in ANSI and ICCB / Power Break II Circuit Breakers

Instantaneous selectivity between a circuit breaker with an EntelliGuard TU trip unit and any non-current limiting circuit breaker may be evaluated via traditional time current curve analysis or simply multiplying the upstream instantaneous trip setting by .9, which accounts for the tolerance of the upstream circuit breaker around the nominal setting. If the EntelliGuard TU's instantaneous zone selective interlocking capability between similarly equipped circuit breakers is employed, then selectivity, up to the upstream circuit breaker's full withstand or short circuit rating, is possible.

The table below identifies maximum instantaneous pickup multipliers possible for various types and sizes of GE circuit breakers. The lower part of table identifies the maximum instantaneous pickup in amperes for various circuit breaker, sensor and rating plug combinations. If you compare this value with the values in the third column of the preceding table, you can tell if a pair of CB can be selective. See the example following this table.

Downstream device with EntelliGuard TU Trip Unit		Power Break II, UL 489 CB	WavePro or AKR, ANSI CB	EntelliGuard G, ANSI/UL Std I	EntelliGuard G, ANSI Ext I
		Max Instantaneous in X		Max Instantaneous in X	
Frame determines maximum instantaneous pickup (X) for PB II and WP CB. Plug/lcw ratio determines maximum possible for EntelliGuard G CB. EntelliGuard values shown are more maximum withstand tiers.	800A frame	15	15	15	30
	1600A frame	15	15	15	30
	2000A frame	15	15	15	30
	3000A frame	13	N/A	15	30
	3200A frame	N/A	13	15	30
	4000A frame	10	10	15	23
	5000A frame	N/A	7	15	19
	6000A frame (UL 489 only)	N/A	N/A	15	N/A
	Amperes per above multipliers				
	800A frame, 800A plug	12,000	12,000	12,000	24,000
	1600Aframe,1600Aplug	24,000	24,000	24,000	48,000
	2000Aframe,2000Aplug	30,000	30,000	30,000	60,000
	3000Aframe,3000Aplug	39,000	N/A	45,000	90,000
	3200Aframe,3200Aplug	N/A	41,600	48,000	96,000
	4000Aframe,4000Aplug	40,000	40,000	60,000	92,000
5000Aframe,5000Aplug	N/A	35,000	75,000	95,000	
6000Aframe,6000Aplug	N/A	N/A	90,000	N/A	

Maximum instantaneous is a multiple of rating plug. The above values may be lower if a smaller rating plug than maximum for frame is used. In PB II & WavePro circuit breakers, the maximum instantaneous multiplier is limited by frame rating. In EntelliGuard G, the maximum Instantaneous X may be limited by circuit breaker withstand or short time rating (also known as lcw). The current numbers above multiplied by 0.9 provide maximum selectivity above non current limiting if instantaneous is adjusted to maximum and no zone selective interlocking is used.



EntelliGuard TU Trip Units in ANSI and ICCB/Power Break II Circuit Breakers (example)

Selectivity with EntelliGuard TU Trip Units in ANSI and ICCB / Power Break II Circuit Breakers

Example:

800A WavePro, Power Break II and EntelliGuard G UL at 800A have a maximum instantaneous of 15X (12,000A). This setting is "not" higher than the required 20,360A setting to be selective with a Record Plus G frame 600A circuit breaker. However, an EntelliGuard G ANSI circuit breaker with Extended Range option has a maximum setting of 30X or 24,000A. This is higher than 20,360A, so that circuit breaker can be selective with the 600A Record Plus G frame. A setting of 27X is high enough.

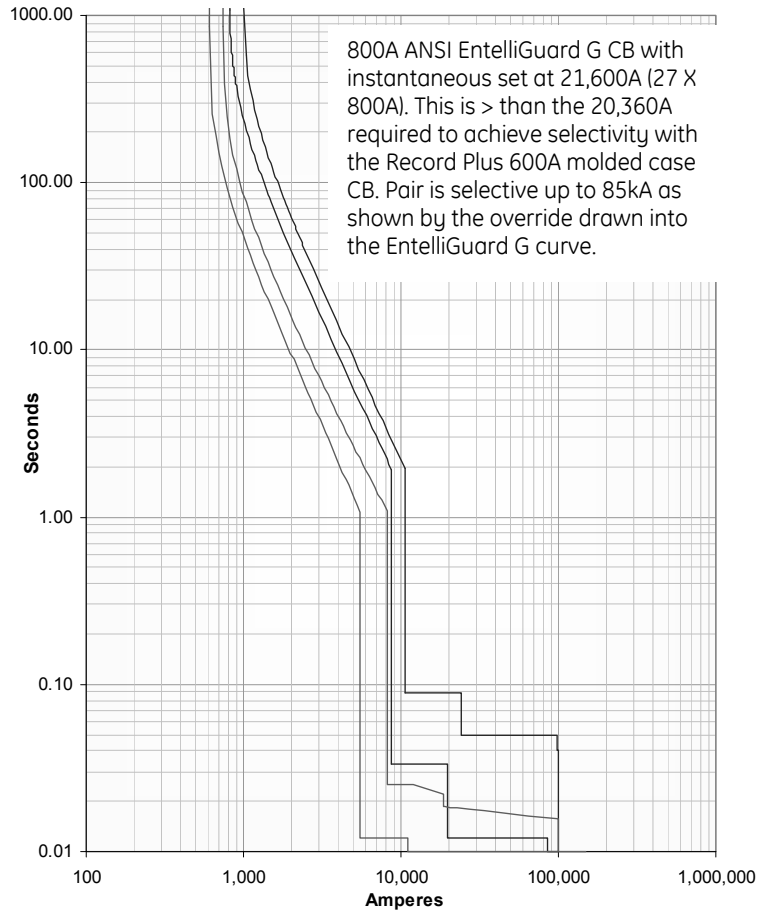

Instantaneous ZSI on EntelliGuard TU Trip Units in ANSI WavePro Circuit Breakers

Selectivity with EntelliGuard TU Trip Units in ANSI WavePro Circuit Breakers

Maximum instantaneous selectivity that may be achieved using **Instantaneous Zone Selective Interlocking** between these WavePro Low Voltage Power Circuit Breakers. Limited by short circuit rating of downstream device or upstream device.

Downstream	Upstream													
	WavePro ANSI Low Voltage Power CB. Long Time Curves, short time pickup and instantaneous pick up must be adjusted per TCC													
Wave Pro	WPS-08	WPH-08	WPX-08	WPS-16	WPH-16	WPX-16	WPS-20	WPS-32	WPH-32	WPX-32	WPS-40	WPX-40	WPS-50	WPX-50
WPS-08	30	30	30	30	30	30	30	30	30	30	30	30	30	30
WPH-08	30	42	42	30	42	42	42	42	42	42	42	42	42	42
WPX-08	30	42	65	30	42	65	65	65	65	65	65	65	65	65
WPS-16				30	30	30	30	30	30	30	30	30	30	30
WPH-16				30	42	42	42	42	42	42	42	42	42	42
WPX-16				30	42	65	65	65	65	65	65	65	65	65
WPS-20							65	65	65	65	65	65	65	65
WPS-32								65	65	65	65	65	65	65
WPH-32								65	85	85	85	85	85	85
WPX-32								65	85	100	85	100	85	100
WPS-40											85	85	85	85
WPX-40											85	100	85	100
WPS-50													85	85
WPX-50													85	100

Selectivity values are shown in kA.



Instantaneous ZSI on EntelliGuard TU Trip Units in ANSI EntelliGuard G Circuit Breakers

Selectivity with EntelliGuard TU Trip Units in ANSI EntelliGuard G Circuit Breakers

Maximum instantaneous selectivity that may be achieved using **Instantaneous Zone Selective Interlocking (I-ZSI)** between these EntelliGuard ANSI (UL 1066) circuit breakers. Limited by short circuit rating of downstream device, and withstand rating of upstream device.

Downstream		Upstream											
EntelliGuard G, ANSI CB		EntelliGuard G ANSI Low Voltage Power CB. Long Time Curves, Short Time pickup and Instantaneous pickup must be adjusted per TCC											
Frame & Sensor	AIC Tier, at 240 & 480V	800A				1600A				2000A			
		N-65kA	H-85kA	E-85kA	M-100kA	N-65kA	H-85kA	E-85kA	M-100kA	N-65kA	H-85kA	E-85kA	M-100kA
800A	N-65kA	65	65	65	65	65	65	65	65	65	65	65	65
800A	H-85kA	65	65	85	85	65	65	85	85	65	65	85	85
800A	E-85kA	65	65	85	85	65	65	85	85	65	65	85	85
800A	M-100kA	65	65	85	85	65	65	85	85	65	65	85	85
1600A	N-65kA					65	65	65	65	65	65	65	65
1600A	H-85kA					65	65	85	85	65	65	85	85
1600A	E-85kA					65	65	85	85	65	65	85	85
1600A	M-100kA					65	65	85	85	65	65	85	85
2000A	N-65kA									65	65	65	65
2000A	H-85kA									65	65	85	85
2000A	E-85kA									65	65	85	85
2000A	M-100kA									65	65	85	85
3200A	N-65kA												
3200A	E-85kA												
3200A	M-100kA												
3200A	B-100kA												
3200A	L-150kA												
4000A	M-100kA												
4000A	B-100kA												
4000A	L-150kA												
5000A	M-100kA												
5000A	B-100kA												
5000A	L-150kA												

Selectivity values are shown in kA.

Continued on next page



Instantaneous ZSI on EntelliGuard TU Trip Units in ANSI EntelliGuard G Circuit Breakers

Continued from previous page

Down-stream	EntelliGuard G, ANSI CB	Upstream										
		EntelliGuard G ANSI Low Voltage Power CB. Long Time Curves, Short Time pickup and Instantaneous pickup must be adjusted per TCC										
Frame & Sensor	AIC Tier, at 240 & 480V	3200A					4000A			5000A		
		N-65kA	E-85kA	M-100kA	B-100kA	L-150kA	M-100kA	B-100kA	L-150kA	M-100kA	B-100kA	L-150kA
800A	N-65kA	65	65	65	65	65	65	65	65	65	65	65
800A	H-85kA	65	85	85	85	85	85	85	85	85	85	85
800A	E-85kA	65	85	85	85	85	85	85	85	85	85	85
800A	M-100kA	65	85	85	100	100	85	100	100	85	100	100
1600A	N-65kA	65	65	65	65	65	65	65	65	65	65	65
1600A	H-85kA	65	85	85	85	85	85	85	85	85	85	85
1600A	E-85kA	65	85	85	85	85	85	85	85	85	85	85
1600A	M-100kA	65	85	85	100	100	85	100	100	85	100	100
2000A	N-65kA	65	65	65	65	65	65	65	65	65	65	65
2000A	H-85kA	65	85	85	85	85	85	85	85	85	85	85
2000A	E-85kA	65	85	85	85	85	85	85	85	85	85	85
2000A	M-100kA	65	85	85	100	100	85	100	100	85	100	100
3200A	N-65kA	65	65	65	65	65	65	65	65	65	65	65
3200A	E-85kA	65	85	85	85	85	85	85	85	85	85	85
3200A	M-100kA	65	85	85	100	100	85	100	100	85	100	100
3200A	B-100kA	65	85	85	100	100	85	100	100	85	100	100
3200A	L-150kA	65	85	85	100	100	85	100	100	85	100	100
4000A	M-100kA						85	100	100	85	100	100
4000A	B-100kA						85	100	100	85	100	100
4000A	L-150kA						85	100	100	85	100	100
5000A	M-100kA									85	100	100
5000A	B-100kA									85	100	100
5000A	L-150kA									85	100	100

Selectivity values are shown in kA.



Instantaneous ZSI on EntelliGuard TU Trip Units in UL489 EntelliGuard G Circuit Breakers

Selectivity with EntelliGuard TU Trip Units in ANSI EntelliGuard G Circuit Breakers

Maximum instantaneous selectivity that may be achieved using **Instantaneous Zone Selective Interlocking (I-ZSI)** between these EntelliGuard UL circuit breakers. Limited by short circuit rating of downstream device and withstand rating of upstream device.

Down-stream	EntelliGuard G, UL CB	Upstream								
		EntelliGuard G ANSI Low Voltage Power CB. Long Time Curves, Short Time pickup and Instantaneous pickup must be adjusted per TCC								
		800A N-65kA	800A H-85kA	800A M-100kA	1600A N-65kA	1600A H-85kA	1600A M-100kA	2000A N-65kA	2000A H-85kA	2000A M-100kA
800A	N-65kA	42	50	65	42	50	65	42	50	65
800A	H-85kA	42	50	65	42	50	85	42	50	65
800A	M-100kA	42	50	65	42	50	100	42	50	65
1600A	N-65kA				42	50	65	42	50	65
1600A	H-85kA				42	50	85	42	50	65
1600A	M-100kA				42	50	100	42	50	65
2000A	N-65kA							42	50	65
2000A	H-85kA							42	50	65
2000A	M-100kA							42	50	65
3000A	N-65kA									
3000A	H-85kA									
3000A	M-100kA									
3000A	L-150kA									
4000A	M-100kA									
4000A	L-150kA									
5000A	M-100kA									
5000A	L-150kA									
6000A	M-100kA									
6000A	L-150kA									

Selectivity values are shown in kA.

Continued on next page



Instantaneous ZSI on EntelliGuard TU Trip Units in UL489 EntelliGuard G Circuit Breakers

Continued from previous page

Down-stream	EntelliGuard G, UL CB	Upstream									
		EntelliGuard G ANSI Low Voltage Power CB. Long Time Curves, Short Time pickup and Instantaneous pickup must be adjusted per TCC									
		3000A N-65kA	3000A H-85kA	3000A M-100kA	3000A L-150kA	4000A M-100kA	4000A L-150kA	5000A M-100kA	5000A L-150kA	6000A M-100kA	6000A L-150kA
800A	N-65kA	42	50	65	65	65	65	65	65	65	65
800A	H-85kA	42	50	65	85	65	85	65	85	65	85
800A	M-100kA	42	50	65	85	65	85	65	85	65	85
1600A	N-65kA	42	50	65	65	65	65	65	65	65	65
1600A	H-85kA	42	50	65	85	65	85	65	85	65	85
1600A	M-100kA	42	50	65	85	65	85	65	85	65	85
2000A	N-65kA	42	50	65	65	65	65	65	65	65	65
2000A	H-85kA	42	50	65	85	65	85	65	85	65	85
2000A	M-100kA	42	50	65	85	65	85	65	85	65	85
3000A	N-65kA	42	50	65	65	65	65	65	65	65	65
3000A	H-85kA	42	50	65	85	65	85	65	85	65	85
3000A	M-100kA	42	50	65	85	65	85	65	85	65	85
3000A	L-150kA	42	50	65	85	65	85	65	85	65	85
4000A	M-100kA					65	85	65	85	65	85
4000A	L-150kA					65	85	65	85	65	85
5000A	M-100kA							65	85	65	85
5000A	L-150kA							65	85	65	85
6000A	M-100kA									65	85
6000A	L-150kA									65	85

Selectivity values are shown in kA.



Instantaneous ZSI on Spectra *micro*EntelliGuard Molded Case Circuit Breakers (MCCBs)

The tables that follow show maximum instantaneous selectivity that may be achieved using *Instantaneous Zone Selective Interlocking (I-ZSI)* between downstream Spectra molded case circuit breakers provided with Instantaneous Zone Selective Interlocking (I-ZSI) and upstream GE WavePro Low Voltage Power Circuit Breakers or GE EntelliGuard G circuit breakers also provided with I-ZSI. Selectivity is limited by the short circuit rating of downstream device or upstream device.

Upstream WavePro ANSI Low Voltage Power CB

Downstream Devices: Spectra with <i>micro</i> EntelliGuard (2)	Upstream Devices													
	WPS-08	WPH-08	WPX-08	WPS-16	WPH-16	WPX-16	WPS-20	WPS-32	WPH-32	WPX-32	WPS-40	WPX-40	WPS-50	WPX-50
1200A	(1)	(1)	(1)	30	42	65	65	65	85	100	85	100	85	100
800A	(1)	(1)	(1)	30	42	65	65	65	85	100	85	100	85	100
600A	30	42	65	30	42	65	65	65	85	100	85	100	85	100

Upstream EntelliGuard G ANSI Low Voltage Power CB

Downstream Devices: Spectra with <i>micro</i> EntelliGuard (2)	Upstream Devices											
	800A	800A	800A	800A	1600A	1600A	1600A	1600A	2000A	2000A	2000A	2000A
	N-65kA	H-85kA	E-85kA	M-100kA	N-65kA	H-85kA	E-85kA	M-100kA	N-65kA	H-85kA	E-85kA	M-100kA
1200A	(1)	(1)	(1)	(1)	65	65	85	85	65	65	85	85
800A	(1)	(1)	(1)	(1)	65	65	85	85	65	65	85	85
600A	65	65	85	85	65	65	85	85	65	65	85	85

Downstream Devices: Spectra with <i>micro</i> EntelliGuard (2)	Upstream Devices											
	3200A	3200A	3200A	3200A	3200A	4000A	4000A	4000A	5000A	5000A	5000A	
	N-65kA	E-85kA	M-100kA	B-100kA	L-150kA	M-100kA	B-100kA	L-150kA	M-100kA	B-100kA	L-150kA	
1200A	65	85	85	100	100	85	100	100	85	100	100	
800A	65	85	85	100	100	85	100	100	85	100	100	
600A	65	85	85	100	100	85	100	100	85	100	100	

- 1 Spectra *micro*EntelliGuard circuit breakers may be instantaneously selective if the trip settings allow the Long-Time and Short-Time curves to be selective per examination of the applicable time current curves.
- 2 Spectra G & K circuit breakers are available in multiple short circuit ratings ranging from 35 to 100kA at 480V. Instantaneous selectivity is only possible up to short circuit rating of the lowest device in the selective pair. Selectivity values are shown in kA.



Instantaneous ZSI on Spectra *micro*EntelliGuard Molded Case Circuit Breakers (MCCBs)

Upstream EntelliGuard G UL489 Low Voltage Power CB

Long time curves, short time pickup and instantaneous pickup must be adjusted per TCC.

Downstream Devices: Spectra with <i>micro</i> EntelliGuard (2)	Upstream Devices								
	800A	800A	800A	1600A	1600A	1600A	2000A	2000A	2000A
	N-65kA	H-85kA	M-100kA	N-65kA	H-85kA	M-100kA	N-65kA	H-85kA	M-100kA
1200A	(1)	(1)	(1)	42	50	100	42	50	65
800A	(1)	(1)	(1)	42	50	100	42	50	65
600A	42	50	65	42	50	100	42	50	65

Downstream Devices: Spectra with <i>micro</i> EntelliGuard (2)	Upstream Devices									
	3000A	3000A	3000A	3000A	4000A	4000A	5000A	5000A	6000A	6000A
	N-65kA	H-85kA	M-100kA	L-150kA	M-100kA	L-150kA	M-100kA	L-150kA	M-100kA	L-150kA
1200A	42	50	65	85	65	85	65	85	65	85
800A	42	50	65	85	65	85	65	85	65	85
600A	42	50	65	85	65	85	65	85	65	85

1 Spectra circuit breakers may be instantaneously selective if the trip settings allow the Long-Time and Short-Time curves to be selective per examination of the applicable time current curves, i.e., if the load side Spectra Long-Time, Short-Time and Instantaneous settings are sufficiently lower than that of the line side device.

2 Spectra G & K circuit breakers are available in multiple short circuit ratings ranging from 35 to 100kA at 480V. Instantaneous selectivity is only possible up to short circuit rating of the lowest device in the selective pair.

Selectivity values are shown in kA.

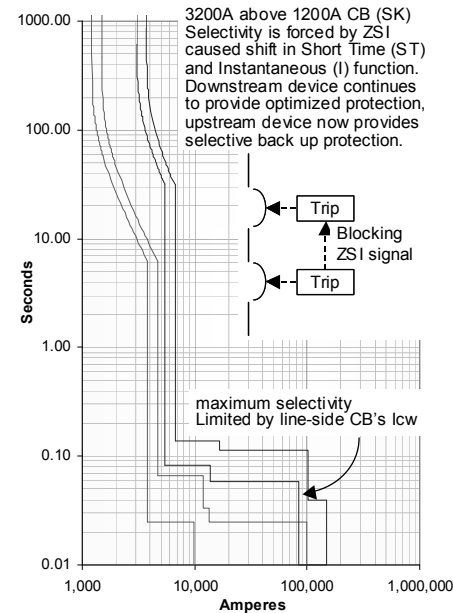
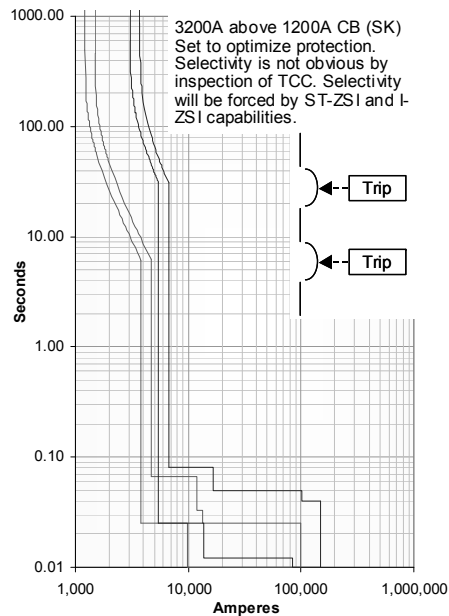

Typical Switchboard / Power Panel Combinations

The tables that follow represent selectivity between upstream GE circuit breakers equipped with MVT, EntelliGuard TU, Record Plus, Spectra RMS or thermal-magnetic trip units and various downstream GE circuit breakers.

For current limiting downstream circuit breakers (as noted,) higher selectivity ratings are possible using upstream EntelliGuard TU trip units as shown in the table on page 9.

Switchboards and Power Panels

Upstream Mains							Downstream Feeders(7)(8)							
Description	Mounting (5)	Amperes			Trip type	Max. Inst. Pickup (X Plug)	ABB S7		FG (6)			FE (6)	SF (6)	SE (6)
		Frame	Sensor	Plug or Trip			1200		600			250	250	150
							1200	1000	600	400	250	250	250	150
							3P	3P	3&2P	3&2P	3&2P	3&2P	3&2P	3&2P
LVPCB(1)	D/O, S	3200-5000A Frame			Adj. (3)	Off	65,000	65,000	100,000	100,000	100,000	100,000	100,000	100,000
LVPCB(1)	D/O, S	800-2000A Frame			Adj. (3)	Off	65,000	65,000	65,000	65,000	65,000	65,000	65,000	65,000
LVPCB	D/O, S	5000	5000	5000	Adj. (4)	7	31,500	31,500	64,700	64,700	64,700	100,000	97,500	100,000
LVPCB/ICCB	D/O, S	4000	4000	4000	Adj	9	32,400	32,400	69,000	69,000	69,000	100,000	100,000	100,000
LVPCB	D/O, S	3200	3200	3200	Adj	13	37,440	37,440	100,000	100,000	100,000	100,000	100,000	100,000
ICCB(2)	D/O, S	3000	3000	3000	Adj	13	35,100	35,100	85,000	85,000	85,000	100,000	100,000	100,000
ICCB	D/O, S	3000	2500	2500	Adj	13	29,250	29,250	54,000	54,000	54,000	100,000	81,600	90,000
LVPCB/ICCB	D/O, S	2000	2000	2000	Adj	15	27,000	27,000	44,000	44,000	44,000	100,000	67,400	73,000
LVPCB/ICCB	D/O, S	1600	1600	1600	Adj	15	21,600	21,600	25,000	25,000	25,000	71,300	40,000	40,000
LVPCB/ICCB	D/O, S	800	800	800	Adj	15	NIS	NIS	NIS	11,000	11,000	14,200	11,000	13,000
MCCB S7	S	1200	1200	None	Adj	1.5-12+ (8)	NIS	NIS	65,000	65,000	65,000	65,000	65,000	65,000
MCCB S7	S	1200	1000	None	Adj	1.5-12+ (8)	NIS	NIS	65,000	65,000	65,000	65,000	65,000	65,000
MCCB FG (6)	S	600	600	600	IPU Only	10 (7)	NIS	NIS	NIS	TCC	TCC	100,000	TCC	TCC
MCCB FG (6)	S	600	400	400	IPU Only	10 (7)	NIS	NIS	NIS	NIS	TCC	TCC	TCC	TCC
MCCB FG (6)	S	600	250	250	IPU Only	10 (7)	NIS	NIS	NIS	NIS	NIS	NIS	NIS	TCC

1 LVPCB = Low Voltage Power Circuit Breakers, GE types WavePro™ or EntelliGuard™. UL listed to UL 1066.

2 ICCB= Insulated Case Circuit Breaker, GE Type Power Break II™. UL listed to UL 489.

3 LVPCB are available with or without instantaneous trips. If provided without instantaneous trips they may be selective up to their short circuit rating or the rating of the device below. Trips typically designated as LS or LSG.

4 Adj = Adjustable trip with LS, LSI, LSG or LSIG characteristics.

5 D/O = Draw out mounting. S = Stationary mounting.

6 Current Limiting Molded Case Circuit Breaker.

7 For FG the maximum adjustment to the IPU (Instantaneous Pick Up) is based on sensor size. All other devices are based on plug size. For trip ratio less than 2 between FG to FB, TEY or THQB, use TCC to determine if there is a short time or long time overlap.

8 S7 instantaneous adjustment is 1.5-12 and off. When off, a 16kA override provides instantaneous protection.

NIS = Not instantaneously selective. Selectivity is not expected as the LT and ST portions of the curve probably overlap.

TCC = Selectivity is best determined by examination of overlaid trip-time-curves and will probably be dependent on specific device settings. Some level of selectivity is possible but may be low.

IPU Only = Only Instantaneous Pickup is adjustable.



Typical Lighting Panel Combinations

Lighting Panels

Continued on next page

Description	Mounting (5)	Upstream Mains					Downstream Feeders(7)(8)							
		Amperes			Trip type	Max. Inst. Pickup (X Plug)	FB (6)	TEY (6)					TEYF (6)	
		Frame	Sensor	Plug or Trip			100	100	100	100	100	100	100	100
							100	100-70	60-35	30-15	60-35	30-15	100-35	30-15
3,2&1P	3,2&1P	3&2P	3&2P	1P	1P	3,2&1P	3,2&1P							
LVPCB(1)	D/O, S	3200-5000A Frame			Adj. (3)	Off	100,000	14,000	14,000	14,000	14,000	14,000	65,000	65,000
LVPCB(1)	D/O, S	800-2000A Frame			Adj. (3)	Off	65,000	14,000	14,000	14,000	14,000	14,000	65,000	65,000
LVPCB	D/O, S	5000	5000	5000	Adj. (4)	7	100,000	14,000	14,000	14,000	14,000	14,000	14,000	14,000
LVPCB/ICCB	D/O, S	4000	4000	4000	Adj	9	100,000	14,000	14,000	14,000	14,000	14,000	14,000	14,000
LVPCB	D/O, S	3200	3200	3200	Adj	13	100,000	14,000	14,000	14,000	14,000	14,000	14,000	14,000
ICCB(2)	D/O, S	3000	3000	3000	Adj	13	100,000	14,000	14,000	14,000	14,000	14,000	14,000	14,000
ICCB	D/O, S	3000	2500	2500	Adj	13	100,000	14,000	14,000	14,000	14,000	14,000	14,000	14,000
LVPCB/ICCB	D/O, S	2000	2000	2000	Adj	15	100,000	14,000	14,000	14,000	14,000	14,000	14,000	14,000
LVPCB/ICCB	D/O, S	1600	1600	1600	Adj	15	100,000	14,000	14,000	14,000	14,000	14,000	14,000	14,000
LVPCB/ICCB	D/O, S	800	800	800	Adj	15	35,000	12,800	12,800	12,800	12,800	12,800	14,000	14,000
MCCB S7	S	1200	1200	None	Adj	1.5-12+ (9)	65,000	14,000	14,000	14,000	14,000	14,000	14,000	14,000
MCCB S7	S	1200	1000	None	Adj	1.5-12+ (9)	65,000	14,000	14,000	14,000	14,000	14,000	14,000	14,000
MCCB (6) FG (8)	S	600	600	600	IPU Only	10 (7)	65,000	6,000	10,000	14,000	10,000	14,000	14,000	14,000
MCCB FG (6) (8)	S	600	400	400	IPU Only	10 (7)	65,000	4,000	10,000	14,000	10,000	14,000	14,000	14,000
MCCB FG (6) (8)	S	600	250	250	IPU Only	10 (7)	65,000	2,500	2,500	14,000	2,500	14,000	14,000	14,000
MCCB FE	S	250	250	250	Adj	13	TCC	TCC	TCC	10,000	TCC	10,000	TCC	14,000

- 1 LVPCB = Low Voltage Power Circuit Breakers, GE types WavePro™ or EntelliGuard™. UL listed to UL 1066.
 - 2 ICCB= Insulated Case Circuit Breaker, GE Type Power Break II™. UL listed to UL 489.
 - 3 LVPCB are available with or without instantaneous trips. If provided without instantaneous trips they may be selective up to their short circuit rating or the rating of the device below. Trips typically designated as LS or LSG.
 - 4 Adj = Adjustable trip with LS, LSI, LSG or LSI characteristics.
 - 5 D/O = Draw out mounting. S = Stationary mounting.
 - 6 Current Limiting Molded Case Circuit Breaker. Use upstream EntelliGuard TU for highest selectivity ratings.
 - 7 For FG the maximum adjustment to the IPU (Instantaneous Pickup) is based on sensor size. All other devices are based on plug size. All other devices are based on plug size. For trip ratio less than 2 between FG to FB, TEY or THQB, use TCC to determine if there is a short time or long time overlap.
 - 8 FG to FB selectivity for circuit breaker pairs with a trip ratio of less than 2 should be verified with time current curves. FG to TEY selectivity for circuit breaker pairs with a trip ratio of less than 1.6 should be verified with time current curves.
 - 9 S7 instantaneous adjustment is 1.5-12 and off. When off, a 16kA override provides instantaneous protection.
- NIS = Not instantaneously selective. Selectivity is not expected as the LT and ST portions of the curve probably overlap.
TCC = Selectivity is best determined by examination of overlaid trip-time-curves and will probably be dependent on specific device settings. Some level of selectivity is possible but may be low.
IPU Only = Only Instantaneous Pickup is adjustable.



Typical Lighting Panel Combinations

Lighting Panels (continued from previous page)

Description	Mounting (5)	Upstream Mains				Downstream Feeders						
		Amperes			Trip type	Max. Inst. Pickup (X Plug)	THQB, THHQB (6)					
		Frame	Sensor	Plug or Trip			125	125	125	125	125	125
							125	100-70	60-35	30-15	60-35	30-15
				2P	3,2&1P	3&2P	3&2P	1P	1P			
LVPCB(1)	D/O, S	3200-5000A Frame			Adj. (3)	Off	22,000	22,000	22,000	22,000	22,000	22,000
LVPCB(1)	D/O, S	800-2000A Frame			Adj. (3)	Off	22,000	22,000	22,000	22,000	22,000	22,000
LVPCB	D/O, S	5000	5000	5000	Adj. (4)	7	22,000	22,000	22,000	22,000	22,000	22,000
LVPCB/ICCB	D/O, S	4000	4000	4000	Adj	9	22,000	22,000	22,000	22,000	22,000	22,000
LVPCB	D/O, S	3200	3200	3200	Adj	13	22,000	22,000	22,000	22,000	22,000	22,000
ICCB(2)	D/O, S	3000	3000	3000	Adj	13	22,000	22,000	22,000	22,000	22,000	22,000
ICCB	D/O, S	3000	2500	2500	Adj	13	22,000	22,000	22,000	22,000	22,000	22,000
LVPCB/ICCB	D/O, S	2000	2000	2000	Adj	15	22,000	22,000	22,000	22,000	22,000	22,000
LVPCB/ICCB	D/O, S	1600	1600	1600	Adj	15	22,000	22,000	22,000	22,000	22,000	22,000
LVPCB/ICCB	D/O, S	800	800	800	Adj	15	18,100	18,100	18,100	18,100	18,100	18,100
MCCB S7	S	1200	1200	None	Adj	1.5-12+ (9)	22,000	22,000	22,000	22,000	22,000	22,000
MCCB S7	S	1200	1000	None	Adj	1.5-12+ (9)	22,000	22,000	22,000	22,000	22,000	22,000
MCCB FG (6) (8)	S	600	600	600	IPU Only	10 (7)	22,000	22,000	22,000	22,000	22,000	22,000
MCCB FG (6) (8)	S	600	400	400	IPU Only	10 (7)	22,000	22,000	22,000	22,000	22,000	22,000
MCCB FG (6) (8)	S	600	250	250	IPU Only	10 (7)	2,500	2,500	10,000	22,000	10,000	22,000
MCCB FE	S	250	250	250	IPU Only	13	TCC	TCC	4,000	6,000	TCC	14,000

1 LVPCB = Low Voltage Power Circuit Breakers, GE types WavePro™ or EntelliGuard™. UL listed to UL 1066.

2 ICCB= Insulated Case Circuit Breaker, GE Type Power Break II™. UL listed to UL 489.

3 LVPCB are available with or without instantaneous trips. If provided without instantaneous trips they may be selective up to their short circuit rating or the rating of the device below. Trips typically designated as LS or LSG.

4 Adj = Adjustable trip with LS, LSI, LSG or LSIG characteristics.

5 D/O = Draw out mounting. S = Stationary mounting.

6 Current Limiting Molded Case Circuit Breaker. Use upstream EntelliGuard TU for highest selectivity ratings.

7 For FG the maximum adjustment to the IPU (Instantaneous Pick Up) is based on sensor size. All other devices are based on plug size.

8 FG to THQB selectivity for circuit breaker pairs with a trip ratio of less than 1.6 should be verified with time current curves.

9 S7 instantaneous adjustment is 1.5-12 and off. When off, a 16kA override provides instantaneous protection.

NIS = Not instantaneously selective. Selectivity is not expected as the LT and ST portions of the curve probably overlap.

TCC = Selectivity is best determined by examination of overlaid trip-time-curves and will probably be dependent on specific device settings. Some level of selectivity is possible but may be low.

IPU Only = Only Instantaneous Pickup is adjustable.



Stored Energy Mains

Upstream: Stored energy with adjustable electronic LSI or LSIG trip types					Downstream: ANSI or ICCB with MVT LSI or LSIG trip without I-ZSI							
Type	Amperes			Max. Inst. Pickup (X Plug)	Type Plug	ANSI/ICCB	ANSI/ICCB	ANSI	ICCB	ANSI	ICCB	ANSI
	Frame	Sensor	Plug or trip			4,000A	3,600A	3,200A	3,000A	3,000A	2,500A	2,400A
ANSI	5,000	5,000	5,000	7		TCC	TCC	TCC	TCC	31,500	TCC	TCC
ANSI & ICCB	4,000	4,000	4,000	9		TCC	TCC	TCC	TCC	32,400	TCC	TCC
ANSI & ICCB	4,000	3,600	3,600	9		NIS	TCC	TCC	TCC	TCC	TCC	TCC
ANSI	3,200	3,200	3,200	13		NIS	NIS	TCC	TCC	TCC	37,440	37,440
ICCB	3,000	3,000	3,000	13		NIS	NIS	NIS	TCC	TCC	TCC	35,100
ANSI	4,000	3,000	3,000	9		NIS	NIS	NIS	TCC	TCC	TCC	TCC
ICCB	3,000	2,500	2,500	13		NIS	NIS	NIS	NIS	NIS	TCC	TCC
ANSI	3,200	3,200	2,400	13		NIS	NIS	NIS	NIS	NIS	NIS	TCC
ANSI & ICCB	2,000	2,000	2,000	15		NIS	NIS	NIS	NIS	NIS	NIS	NIS
ANSI & ICCB	1,600	1,600	1,600	15		NIS	NIS	NIS	NIS	NIS	NIS	NIS
ANSI & ICCB	1,600	1,600	1,200	15		NIS	NIS	NIS	NIS	NIS	NIS	NIS
ANSI & ICCB	1,600	1,600	1,000	15		NIS	NIS	NIS	NIS	NIS	NIS	NIS
ANSI & ICCB	800	800	800	15		NIS	NIS	NIS	NIS	NIS	NIS	NIS
ANSI & ICCB	800	800	400	15		NIS	NIS	NIS	NIS	NIS	NIS	NIS
ANSI & ICCB	800	800	150	15		NIS	NIS	NIS	NIS	NIS	NIS	NIS

NIS = not instantaneously selective. TCC = refer to time current curve.

ANSI = AKR, WavePro & EntelliGuard

ICCB = Power Break II

Continued on next page



Stored Energy Mains

Continued from previous page

Upstream: Stored energy with adjustable electronic LSI or LSIG trip types					Downstream: ANSI or ICCB with MVT LSI or LSIG trip without I-ZSI							
Type	Amperes			Max. Inst. Pickup (X Plug)	Plug	2,000A	1,600A	1,200A	1,000A	800A	400A	150A
	Frame	Sensor	Plug or trip									
ANSI	5,000	5,000	5,000	7	TCC	31,500	31,500	31,500	31,500	31,500	31,500	31,500
ANSI & ICCB	4,000	4,000	4,000	9	TCC	32,400	32,400	32,400	32,400	32,400	32,400	32,400
ANSI & ICCB	4,000	3,600	3,600	9	TCC	29,160	29,160	29,160	29,160	29,160	29,160	29,160
ANSI	3,200	3,200	3,200	13	37,440	37,440	37,440	37,440	37,440	37,440	37,440	37,440
ICCB	3,000	3,000	3,000	13	35,100	35,100	35,100	35,100	35,100	35,100	35,100	35,100
ANSI	4,000	3,000	3,000	9	TCC	TCC	24,300	24,300	24,300	24,300	24,300	24,300
ICCB	3,000	2,500	2,500	13	TCC	29,250	29,250	29,250	29,250	29,250	29,250	29,250
ANSI	3,200	3,200	2,400	13	TCC	28,080	28,080	28,080	28,080	28,080	28,080	28,080
ANSI & ICCB	2,000	2,000	2,000	15	TCC	27,000	27,000	27,000	27,000	27,000	27,000	27,000
ANSI & ICCB	1,600	1,600	1,600	15	NIS	TCC	21,600	21,600	21,600	21,600	21,600	21,600
ANSI & ICCB	1,600	1,600	1,200	15	NIS	NIS	TCC	TCC	16,200	16,200	16,200	
ANSI & ICCB	1,600	1,600	1,000	15	NIS	NIS	NIS	TCC	13,500	13,500	13,500	
ANSI & ICCB	800	800	800	15	NIS	NIS	NIS	NIS	TCC	10,800	10,800	
ANSI & ICCB	800	800	400	15	NIS	NIS	NIS	NIS	NIS	TCC	5,400	
ANSI & ICCB	800	800	150	15	NIS	NIS	NIS	NIS	NIS	NIS	TCC	

NIS = not instantaneously selective. TCC = refer to time current curve.

ANSI = AKR, WavePro & EntelliGuard

ICCB = Power Break II

Continued on next page



Stored Energy Mains

Upstream: Stored energy with adjustable electronic LSI or LSIIG trip types					Downstream: Spectra MCCB with LSI or LSIIG MVT										
Type	Amperes			Max. Inst. Pickup (X Plug)	Plug	1200A SK									
	Frame	Sensor	Plug or trip			1200A	1000A	800A	700A	600A	500A	450A	400A	350A	300A
ANSI	5,000	5,000	5,000	7		31,500	31,500	31,500	31,500	31,500	31,500	31,500	31,500	31,500	31,500
ANSI & ICCB	4,000	4,000	4,000	9		32,400	32,400	32,400	32,400	32,400	32,400	32,400	32,400	32,400	32,400
ANSI & ICCB	4,000	3,600	3,600	9		29,160	29,160	29,160	29,160	29,160	29,160	29,160	29,160	29,160	29,160
ANSI	3,200	3,200	3,200	13		37,440	37,440	37,440	37,440	37,440	37,440	37,440	37,440	37,440	37,440
ICCB	3,000	3,000	3,000	13		35,100	35,100	35,100	35,100	35,100	35,100	35,100	35,100	35,100	35,100
ANSI	4,000	3,000	3,000	9		24,300	24,300	24,300	24,300	24,300	24,300	24,300	24,300	24,300	24,300
ICCB	3,000	2,500	2,500	13		29,250	29,250	29,250	29,250	29,250	29,250	29,250	29,250	29,250	29,250
ANSI	3,200	3,200	2,400	13		28,080	28,080	28,080	28,080	28,080	28,080	28,080	28,080	28,080	28,080
ANSI & ICCB	2,000	2,000	2,000	15		27,000	27,000	27,000	27,000	27,000	27,000	27,000	27,000	27,000	27,000
ANSI & ICCB	1,600	1,600	1,600	15		TCC	21,600	21,600	21,600	21,600	21,600	21,600	21,600	21,600	21,600
ANSI & ICCB	1,600	1,600	1,200	15		NIS	NIS	16,200	16,200	16,200	16,200	16,200	16,200	16,200	16,200
ANSI & ICCB	1,600	1,600	1,000	15		NIS	NIS	TCC	13,500	13,500	13,500	13,500	13,500	13,500	13,500
ANSI & ICCB	800	800	800	15		NIS	NIS	NIS	NIS	TCC	10,800	10,800	10,800	10,800	10,800
ANSI & ICCB	800	800	400	15		NIS	NIS	NIS	NIS	NIS	NIS	NIS	NIS	NIS	TCC
ANSI & ICCB	800	800	150	15		NIS	NIS	NIS	NIS	NIS	NIS	NIS	NIS	NIS	NIS

NIS = not instantaneously selective. TCC = refer to time current curve.

ANSI = AKR, WavePro & EntelliGuard

ICCB = Power Break II



Stored Energy Mains

Upstream: Stored energy with adjustable electronic LSI or LSIG trip types					Downstream: Spectra MCCB with LSI or LSIG MVT						
Type	Amperes			Max. Inst. Pickup (X Plug)	Plug	600A SG (1)					
	Frame	Sensor	Plug or trip			600A	500A	450-300A	250A	225-125A	100-60A
ANSI	5,000	5,000	5,000	7		36,700	36,700	36,700	36,700	36,700	36,700
ANSI & ICCB	4,000	4,000	4,000	9		38,700	38,700	38,700	38,700	38,700	38,700
ANSI & ICCB	4,000	3,600	3,600	9		32,000	32,000	32,000	32,000	32,000	32,000
ANSI	3,200	3,200	3,200	13		54,200	54,200	54,200	54,200	54,200	54,200
ICCB	3,000	3,000	3,000	13		46,000	46,000	46,000	46,000	46,000	46,000
ANSI	4,000	3,000	3,000	9		24,400	24,400	24,400	24,400	24,400	24,400
ICCB	3,000	2,500	2,500	13		32,100	32,100	32,100	32,100	32,100	32,100
ANSI	3,200	3,200	2,400	13		30,000	30,000	30,000	30,000	30,000	30,000
ANSI & ICCB	2,000	2,000	2,000	15		28,300	28,300	28,300	28,300	28,300	28,300
ANSI & ICCB	1,600	1,600	1,600	15		21,600	21,600	21,600	21,600	21,600	21,600
ANSI & ICCB	1,600	1,600	1,200	15		16,200	16,200	16,200	16,200	16,200	16,200
ANSI & ICCB	1,600	1,600	1,000	15		TCC	13,500	13,500	13,500	13,500	13,500
ANSI & ICCB	800	800	800	15		NIS	TCC	10,800	10,800	10,800	10,800
ANSI & ICCB	800	800	400	15		NIS	NIS	NIS	TCC	5,400	5,400
ANSI & ICCB	800	800	150	15		NIS	NIS	NIS	NIS	NIS	TCC

1 Current Limiting Molded Case Circuit Breaker. Use upstream EntelliGuard TU for highest selectivity ratings.

NIS = not instantaneously selective. TCC = refer to time current curve.

ANSI = AKR, WavePro & EntelliGuard

ICCB = Power Break II



Stored Energy Mains

Upstream: Stored energy with adjustable electronic LSI or LSIG trip types					Spectra current limiting MCCBs					
Type	Amperes			Max. Inst. Pickup (X Plug)	Spectra E and F (1)					
	Frame	Sensor	Plug or trip		Trip	250A	150A	60-35A	30-15A	7-3A, MCP only
ANSI	5,000	5,000	5,000	7		97,500	100,000	100,000	100,000	100,000
ANSI & ICCB	4,000	4,000	4,000	9		100,000	100,000	100,000	100,000	100,000
ANSI & ICCB	4,000	3,600	3,600	9		81,000	93,700	100,000	100,000	100,000
ANSI	3,200	3,200	3,200	13		100,000	100,000	100,000	100,000	100,000
ICCB	3,000	3,000	3,000	13		100,000	100,000	100,000	100,000	100,000
ANSI	4,000	3,000	3,000	9		52,500	52,500	64,400	100,000	100,000
ICCB	3,000	2,500	2,500	13		81,600	90,000	100,000	100,000	100,000
ANSI	3,200	3,200	2,400	13		74,000	81,300	100,000	100,000	100,000
ANSI & ICCB	2,000	2,000	2,000	15		67,400	73,000	100,000	100,000	100,000
ANSI & ICCB	1,600	1,600	1,600	15		40,000	39,600	48,100	100,000	100,000
ANSI & ICCB	1,600	1,600	1,200	15		21,200	23,100	27,000	43,500	80,100
ANSI & ICCB	1,600	1,600	1,000	15		14,600	17,400	19,300	27,300	41,900
ANSI & ICCB	800	800	800	15		TCC	12,800	13,700	17,600	23,400
ANSI & ICCB	800	800	400	15		TCC	TCC	TCC	TCC	TCC
ANSI & ICCB	800	800	150	15		TCC	TCC	TCC	TCC	TCC

1 Current Limiting Molded Case Circuit Breaker. Use upstream EntelliGuard TU for highest selectivity ratings.

NIS = not instantaneously selective. TCC = refer to time current curve.

ANSI = AKR, WavePro & EntelliGuard

ICCB = Power Break II

MCP = motor circuit protector



Stored Energy Mains

Upstream: Stored energy with adjustable electronic LSI or LSIG trip types					Record Plus current limiting MCCBs (1)			
Type	Amperes			Max. Inst. Pickup (X Plug)	600A Sensor FG	400A Sensor FG	250A Sensor FG	100-15A FB
	Frame	Sensor	Plug or trip					
ANSI	5,000	5,000	5,000	7	64,700	64,700	64,700	100,000
ANSI & ICCB	4,000	4,000	4,000	9	69,000	69,000	69,000	100,000
ANSI & ICCB	4,000	3,600	3,600	9	53,000	53,000	53,000	100,000
ANSI	3,200	3,200	3,200	13	100,000	100,000	100,000	100,000
ICCB	3,000	3,000	3,000	13	85,000	85,000	85,000	100,000
ANSI	4,000	3,000	3,000	9	34,000	34,000	34,000	100,000
ICCB	3,000	2,500	2,500	13	54,000	54,000	54,000	100,000
ANSI	3,200	3,200	2,400	13	49,000	49,000	49,000	100,000
ANSI & ICCB	2,000	2,000	2,000	15	44,000	44,000	44,000	100,000
ANSI & ICCB	1,600	1,600	1,600	15	25,000	25,000	25,000	100,000
ANSI & ICCB	1,600	1,600	1,200	15	16,200	16,200	16,200	71,200
ANSI & ICCB	1,600	1,600	1,000	15	13,500	13,500	13,500	44,100
ANSI & ICCB	800	800	800	15	TCC	11,000	11,000	35,000
ANSI & ICCB	800	800	400	15	NIS	TCC	TCC	TCC
ANSI & ICCB	800	800	150	15	NIS	TCC	TCC	TCC

1 Current Limiting Molded Case Circuit Breaker. Use upstream EntelliGuard TU for highest selectivity ratings.

NIS = not instantaneously selective. TCC = refer to time current curve.

ANSI = AKR, WavePro & EntelliGuard

ICCB = Power Break II



Stored Energy Mains

Upstream: Stored energy with adjustable electronic LSI or LSIIG trip types					Thermal magnetic non-current limiting MCCBs used only in lighting panelboards										
Type	Amperes			Max. Inst. Pickup (X Plug)	THK and TK – 1,200A & 800A frames										
	Frame	Sensor	Plug or trip		Trip	1,200A	1,000A	800A	700A	600A	500A	450A	400A	350A	300A
ANSI	5,000	5,000	5,000	7		31,500	31,500	31,500	31,500	31,500	31,500	31,500	31,500	31,500	31,500
ANSI & ICCB	4,000	4,000	4,000	9		32,400	32,400	32,400	32,400	32,400	32,400	32,400	32,400	32,400	32,400
ANSI & ICCB	4,000	3,600	3,600	9		29,160	29,160	29,160	29,160	29,160	29,160	29,160	29,160	29,160	29,160
ANSI	3,200	3,200	3,200	13		TCC	37,440	37,440	37,440	37,440	37,440	37,440	37,440	37,440	37,440
ICCB	3,000	3,000	3,000	13		TCC	35,100	35,100	35,100	35,100	35,100	35,100	35,100	35,100	35,100
ANSI	4,000	3,000	3,000	9		TCC	24,300	24,300	24,300	24,300	24,300	24,300	24,300	24,300	24,300
ICCB	3,000	2,500	2,500	13		NIS	N/A	28,080	28,080	28,080	28,080	28,080	28,080	28,080	28,080
ANSI	3,200	3,200	2,400	13		NIS	TCC	29,250	29,250	29,250	29,250	29,250	29,250	29,250	29,250
ANSI & ICCB	2,000	2,000	2,000	15		NIS	NIS	TCC	TCC	27,000	27,000	27,000	27,000	27,000	27,000
ANSI & ICCB	1,600	1,600	1,600	15		NIS	NIS	NIS	NIS	TCC	21,600	21,600	21,600	21,600	21,600
ANSI & ICCB	1,600	1,600	1,200	15		NIS	NIS	NIS	NIS	NIS	NIS	TCC	16,200	16,200	16,200
ANSI & ICCB	1,600	1,600	1,000	15		NIS	NIS	NIS	NIS	NIS	NIS	NIS	TCC	TCC	13,500
ANSI & ICCB	800	800	800	15		NIS	NIS	NIS	NIS	NIS	NIS	NIS	NIS	NIS	TCC
ANSI & ICCB	800	800	400	15		NIS	NIS	NIS	NIS	NIS	NIS	NIS	NIS	NIS	NIS
ANSI & ICCB	800	800	150	15		NIS	NIS	NIS	NIS	NIS	NIS	NIS	NIS	NIS	NIS

NIS = not instantaneously selective. TCC = refer to time current curve.

ANSI = AKR, WavePro & EntelliGuard

ICCB = Power Break II



Stored Energy Mains

Upstream: Stored energy with adjustable electronic LSI or LSIG trip types					Thermal magnetic non-current limiting MCCBs								
Type	Amperes			Max. Inst. Pickup (X Plug)	TJ, THF and TF - 600, 400 and 225A frames								
	Frame	Sensor	Plug or trip		Type Trip	TJ6	TJ6	TJ6	TJ4	TJ4	TJ4	TF	TF
						600A	500A	450A	400A	350-300A	250A	225-200A	175-70A
ANSI	5,000	5,000	5,000	7	31,500	31,500	31,500	31,500	31,500	31,500	31,500	31,500	
ANSI & ICCB	4,000	4,000	4,000	9	32,400	32,400	32,400	32,400	32,400	32,400	32,400	32,400	
ANSI & ICCB	4,000	3,600	3,600	9	29,160	29,160	29,160	29,160	29,160	29,160	29,160	29,160	
ANSI	3,200	3,200	3,200	13	37,440	37,440	37,440	37,440	37,440	37,440	37,440	37,440	
ICCB	3,000	3,000	3,000	13	35,100	35,100	35,100	35,100	35,100	35,100	35,100	35,100	
ANSI	4,000	3,000	3,000	9	24,300	24,300	24,300	24,300	24,300	24,300	24,300	24,300	
ICCB	3,000	2,500	2,500	13	28,080	28,080	28,080	28,080	28,080	28,080	28,080	28,080	
ANSI	3,200	3,200	2,400	13	29,250	29,250	29,250	29,250	29,250	29,250	29,250	29,250	
ANSI & ICCB	2,000	2,000	2,000	15	27,000	27,000	27,000	27,000	27,000	27,000	27,000	27,000	
ANSI & ICCB	1,600	1,600	1,600	15	21,600	21,600	21,600	21,600	21,600	21,600	21,600	21,600	
ANSI & ICCB	1,600	1,600	1,200	15	16,200	16,200	16,200	16,200	16,200	16,200	16,200	16,200	
ANSI & ICCB	1,600	1,600	1,000	15	TCC	TCC	13,500	13,500	13,500	13,500	13,500	13,500	
ANSI & ICCB	800	800	800	15	NIS	NIS	TCC	TCC	10,800	10,800	10,800	10,800	
ANSI & ICCB	800	800	400	15	NIS	NIS	NIS	NIS	NIS	TCC	TCC	5,400	
ANSI & ICCB	800	800	150	15	NIS	NIS	NIS	NIS	NIS	NIS	NIS	NIS	

NIS = not instantaneously selective. TCC = refer to time current curve.

ANSI = AKR, WavePro & EntelliGuard

ICCB = Power Break II



Stored Energy Mains

Upstream: Stored energy with adjustable electronic LSI or LSIG trip types					Current limiting lighting panel circuit breakers (1)							
Type	Amperes			Max. Inst. Pickup (X Plug)	Type Trip Poles	FB	TEY	TEY	THHQB	THHQB	THQB	THQB
	Frame	Sensor	Plug or trip			15-100A	70-100A	15-60A	125A	15-100A	125A	15-100A
						1/2/3	1/2/3	1/2/3	2	1/2/3	2	1/2/3
ANSI	5,000	5,000	5,000	7		100,000	14,000	14,000	22,000	22,000	10,000	10,000
ANSI & ICCB	4,000	4,000	4,000	9		100,000	14,000	14,000	22,000	22,000	10,000	10,000
ANSI & ICCB	4,000	3,600	3,600	9		100,000	14,000	14,000	22,000	22,000	10,000	10,000
ANSI	3,200	3,200	3,200	13		100,000	14,000	14,000	22,000	22,000	10,000	10,000
ICCB	3,000	3,000	3,000	13		100,000	14,000	14,000	22,000	22,000	10,000	10,000
ANSI	4,000	3,000	3,000	9		100,000	14,000	14,000	22,000	22,000	10,000	10,000
ICCB	3,000	2,500	2,500	13		100,000	14,000	14,000	22,000	22,000	10,000	10,000
ANSI	3,200	3,200	2,400	13		100,000	14,000	14,000	22,000	22,000	10,000	10,000
ANSI & ICCB	2,000	2,000	2,000	15		100,000	14,000	14,000	22,000	22,000	10,000	10,000
ANSI & ICCB	1,600	1,600	1,600	15		100,000	14,000	14,000	22,000	22,000	10,000	10,000
ANSI & ICCB	1,600	1,600	1,200	15		71,200	14,000	14,000	22,000	22,000	10,000	10,000
ANSI & ICCB	1,600	1,600	1,000	15		44,100	14,000	14,000	22,000	22,000	10,000	10,000
ANSI & ICCB	800	800	800	15		35,000	12,800	12,800	18,100	18,100	10,000	10,000
ANSI & ICCB	800	800	400	15		5,400	5,400	5,400	5,400	5,400	5,400	5,400
ANSI & ICCB	800	800	150	15		TCC	TCC	TCC	TCC	TCC	TCC	TCC

1 Current Limiting Molded Case Circuit Breaker. Use upstream EntelliGuard TU for highest selectivity ratings.

NIS = not instantaneously selective. TCC = refer to time current curve.

ANSI = AKR, WavePro & EntelliGuard

ICCB = Power Break II



Stored Energy Mains

Upstream: Stored energy with adjustable electronic LSI or LSIG trip types					Motor circuit protectors (MCPs) with current limiters						
Type	Amperes			Max. Inst. Pickup (X Plug)	TECL						
	Frame	Sensor	Plug or trip		Trip	150A	100A	50A	30A	15A	3A
ANSI	5,000	5,000	5,000	7		100,000	100,000	100,000	100,000	100,000	100,000
ANSI & ICCB	4,000	4,000	4,000	9		100,000	100,000	100,000	100,000	100,000	100,000
ANSI & ICCB	4,000	3,600	3,600	9		100,000	100,000	100,000	100,000	100,000	100,000
ANSI	3,200	3,200	3,200	13		100,000	100,000	100,000	100,000	100,000	100,000
ICCB	3,000	3,000	3,000	13		100,000	100,000	100,000	100,000	100,000	100,000
ANSI	4,000	3,000	3,000	9		100,000	100,000	100,000	100,000	100,000	100,000
ICCB	3,000	2,500	2,500	13		100,000	100,000	100,000	100,000	100,000	100,000
ANSI	3,200	3,200	2,400	13		100,000	100,000	100,000	100,000	100,000	100,000
ANSI & ICCB	2,000	2,000	2,000	15		100,000	100,000	100,000	100,000	100,000	100,000
ANSI & ICCB	1,600	1,600	1,600	15		100,000	100,000	100,000	100,000	100,000	100,000
ANSI & ICCB	1,600	1,600	1,200	15		45,800	100,000	100,000	100,000	100,000	100,000
ANSI & ICCB	1,600	1,600	1,000	15		26,600	59,200	100,000	100,000	100,000	100,000
ANSI & ICCB	800	800	800	15		13,700	30,400	100,000	100,000	100,000	100,000
ANSI & ICCB	800	800	400	15		5,400	5,400	12,400	61,000	100,000	100,000
ANSI & ICCB	800	800	150	15		NIS	TCC	2,025	3,100	13,700	90,000

NIS = not instantaneously selective. TCC = refer to time current curve.

ANSI = AKR, WavePro & EntelliGuard

ICCB = Power Break II



Electronic Trip MCCB

Panelboards, Group & Individually Mounted Switchboards

Upstream: Spectra MCCB with MVT™ Trip LSI trip type, maximum nominal pickup (X) = 10			Downstream: Spectra MCCB with MVT								
Amperes											
Frame	Sensor	Plug	SK			SK & SG		SG	SK & SG	SG	SK & SG
			1,200A	1,200A	1,200A	1,200, 600A	1,200, 600A	600A	1,200, 600, 400A	600A	1,200, 600A
			1,200A	1,200, 800A	1,200, 800A	1,200, 800, 600A	800, 600A	600A	1,200, 800, 600A	400A	1,200, 800, 600A
			1,000A	800A	700A	600A	500A	450A	400A	350A	300A
1,200A SK	1,200	1,200	TCC	10,800	10,800	10,800	10,800	10,800	10,800	10,800	10,800
1,200A SK	1,200	1,000	NIS	TCC	9,000	9,000	9,000	9,000	9,000	9,000	9,000
1,200A SK	1,200, 800	800	NIS	NIS	NIS	TCC	7,200	7,200	7,200	7,200	7,200
1,200A SK	1,200, 800	700	NIS	NIS	NIS	NIS	6,300	6,300	6,300	6,300	6,300
1,200A SK, 600A SG	1,200, 800, 600	600	NIS	NIS	NIS	NIS	TCC	TCC	5,400	5,400	5,400
1,200A SK, 600A SG	800, 600	500	NIS	NIS	NIS	NIS	NIS	NIS	TCC	4,500	4,500
1,200A SK, 600A SG	800, 600	450	NIS	NIS	NIS	NIS	NIS	NIS	NIS	TCC	4,050
1,200A SK, 600A SG	800, 600, 400	400	NIS	NIS	NIS	NIS	NIS	NIS	NIS	NIS	TCC
1,200A SK, 600A SG	800, 600, 400	350	NIS	NIS	NIS	NIS	NIS	NIS	NIS	NIS	NIS

NIS = not instantaneously selective. TCC = refer to time current curve.

Continued on next page



Electronic Trip MCCB

Panelboards, Group & Individually Mounted Switchboards

Continued from previous page

Upstream: Spectra MCCB with MVT™ Trip LSI trip type, maximum nominal pickup (X) = 10			Downstream: Spectra MCCB with MVT trip										
Amperes			SG										
Frame	Sensor	Plug	Frame Sensor Plug	600A	600A	600A	600A	600A	600A	600A	600A	600A	600A
1,200A SK	1,200	1,200		10,800	10,800	10,800	10,800	10,800	10,800	10,800	10,800	10,800	10,800
1,200A SK	1,200	1,000		9,000	9,000	9,000	9,000	9,000	9,000	9,000	9,000	9,000	9,000
1,200A SK	1,200, 800	800		7,200	7,200	7,200	7,200	7,200	7,200	7,200	7,200	7,200	7,200
1,200A SK	1,200, 800	700		6,300	6,300	6,300	6,300	6,300	6,300	6,300	6,300	6,300	6,300
1,200A SK, 600A SG	1,200, 800, 600	600		5,400	5,400	5,400	5,400	5,400	5,400	5,400	5,400	5,400	5,400
1,200A SK, 600A SG	800, 600	500		4,500	4,500	4,500	4,500	4,500	4,500	4,500	4,500	4,500	4,500
1,200A SK, 600A SG	800, 600	450		4,050	4,050	4,050	4,050	4,050	4,050	4,050	4,050	4,050	4,050
1,200A SK, 600A SG	800, 600, 400	400		3,600	3,600	3,600	3,600	3,600	3,600	3,600	3,600	3,600	3,600
1,200A SK, 600A SG	800, 600, 400	350		3,150	3,150	3,150	3,150	3,150	3,150	3,150	3,150	3,150	3,150
1,200A SK, 600A SG	800, 600, 400	300		TCC	TCC	2,700	2,700	2,700	2,700	2,700	2,700	2,700	2,700
600A SG	400	250		NIS	NIS	TCC	2,250	2,250	2,250	2,250	2,250	2,250	2,250
600A SG	400	225		NIS	NIS	NIS	TCC	2,025	2,025	2,025	2,025	2,025	2,025
600A SG	400	200		NIS	NIS	NIS	NIS	TCC	1,800	1,800	1,800	1,800	1,800
600A SG	400, 150	150		NIS	NIS	NIS	NIS	NIS	TCC	1,350	1,350	1,350	1,350
600A SG	150	125		NIS	NIS	NIS	NIS	NIS	NIS	TCC	1,125	1,125	1,125
600A SG	150	100		NIS	NIS	NIS	NIS	NIS	NIS	NIS	TCC	900	900
600A SG	150	80		NIS	NIS	NIS	NIS	NIS	NIS	NIS	NIS	TCC	TCC

NIS = not instantaneously selective. TCC = refer to time current curve.



Electronic Trip MCCB

Panelboards, Group & Individually Mounted Switchboards

Upstream: Spectra MCCB with MVT™ Trip LSI trip type, maximum nominal pickup (X) = 10			Downstream: Spectra MCCB with RMS trip, adjustable instantaneous pickup										
Amperes			SK										
Frame	Sensor	Plug	Frame Sensor Plug	1,200A	1,200A	800A	800A	800A	800A	800A	800A	800A	800A
				1,200A	1,200A	800A	800A	800A	800A	800A	800A	800A	800A
				1,200A	1,000A	800A	700A	600A	500A	450A	400A	350A	300A
1,200A SK	1,200	1,200		NIS	NIS	TCC	10,800	10,800	10,800	10,800	10,800	10,800	10,800
1,200A SK	1,200	1,000		NIS	NIS	NIS	NIS	9,000	9,000	9,000	9,000	9,000	9,000
1,200A SK	1,200, 800	800		NIS	NIS	NIS	NIS	NIS	7,200	7,200	7,200	7,200	7,200
1,200A SK	1,200, 800	700		NIS	NIS	NIS	NIS	NIS	NIS	TCC	6,300	6,300	6,300
1,200A SK, 600A SG	1,200, 800, 600	600		NIS	NIS	NIS	NIS	NIS	NIS	NIS	TCC	5,400	5,400
1,200A SK, 600A SG	800, 600	500		NIS	NIS	NIS	NIS	NIS	NIS	NIS	NIS	NIS	4,500
1,200A SK, 600A SG	800, 600	450		NIS	NIS	NIS	NIS	NIS	NIS	NIS	NIS	NIS	TCC
1,200A SK, 600A SG	800, 600, 400	400		NIS	NIS	NIS	NIS	NIS	NIS	NIS	NIS	NIS	NIS
1,200A SK, 600A SG	800, 600, 400	350		NIS	NIS	NIS	NIS	NIS	NIS	NIS	NIS	NIS	NIS

NIS = not instantaneously selective. TCC = refer to time current curve.



Electronic Trip MCCB

Panelboards, Group & Individually Mounted Switchboards

Upstream: Spectra MCCB with MVT™ Trip LSI trip type, maximum nominal pickup (X) = 10			Downstream: Spectra MCCB with RMS trip, adjustable instantaneous pickup											
Amperes			SG											
Frame	Sensor	Plug	Frame	600A	600A	600A	400A	400A	400A	400A	400A	400A	400A	400A
			Sensor	600A	600A	600A	400A	400A	400A	400A	400A	400A	400A	400A
			Plug	600A	500A	450A	400A	350A	300A	250A	200A	175A	150A	125A
1,200A SK	1,200	1,200		10,800	10,800	10,800	10,800	10,800	10,800	10,800	10,800	10,800	10,800	10,800
1,200A SK	1,200	1,000		9,000	9,000	9,000	9,000	9,000	9,000	9,000	9,000	9,000	9,000	9,000
1,200A SK	1,200, 800	800		NIS	7,200	7,200	7,200	7,200	7,200	7,200	7,200	7,200	7,200	7,200
1,200A SK	1,200, 800	700		NIS	NIS	TCC	6,300	6,300	6,300	6,300	6,300	6,300	6,300	6,300
1,200A SK, 600A SG	1,200, 800, 600	600		NIS	NIS	NIS	TCC	5,400	5,400	5,400	5,400	5,400	5,400	5,400
1,200A SK, 600A SG	800, 600	500		NIS	NIS	NIS	NIS	NIS	4,500	4,500	4,500	4,500	4,500	4,500
1,200A SK, 600A SG	800, 600	450		NIS	NIS	NIS	NIS	NIS	TCC	4,050	4,050	4,050	4,050	4,050
1,200A SK, 600A SG	800, 600, 400	400		NIS	NIS	NIS	NIS	NIS	NIS	3,600	3,600	3,600	3,600	3,600
1,200A SK, 600A SG	800, 600, 400	350		NIS	NIS	NIS	NIS	NIS	NIS	NIS	3,150	3,150	3,150	3,150
1,200A SK, 600A SG	800, 600, 400	300		NIS	NIS	NIS	NIS	NIS	NIS	NIS	TCC	2,700	2,700	2,700
600A SG	400	250		NIS	NIS	NIS	NIS	NIS	NIS	NIS	NIS	NIS	2,250	2,250
600A SG	400	225		NIS	NIS	NIS	NIS	NIS	NIS	NIS	NIS	NIS	TCC	2,025
600A SG	400	200		NIS	NIS	NIS	NIS	NIS	NIS	NIS	NIS	NIS	NIS	1,800
600A SG	400, 150	150		NIS	NIS	NIS	NIS	NIS	NIS	NIS	NIS	NIS	NIS	NIS

NIS = not instantaneously selective. TCC = refer to time current curve



Electronic Trip MCCB

Panelboards, Group & Individually Mounted Switchboards

Upstream: Spectra MCCB with MVT™ Trip LSI trip type, maximum nominal pickup (X) = 10			Downstream: SF with RMS trip, adjustable instantaneous pickup										
Amperes			SF										
Frame	Sensor	Plug	Frame Sensor Plug	250A	250A	250A	250A	250A	250A	250A	250A	250A	250A
				250A	250A	250A	250A	250A	250A	250A	250A	250A	250A
				250A	225A	200A	175A	150A	125A	110A	100A	90A	70A
1,200A SK	1,200	1,200		10,800	10,800	10,800	10,800	10,800	10,800	10,800	10,800	10,800	10,800
1,200A SK	1,200	1,000		9,000	9,000	9,000	9,000	9,000	9,000	9,000	9,000	9,000	9,000
1,200A SK	1,200, 800	800		7,200	7,200	7,200	7,200	7,200	7,200	7,200	7,200	7,200	7,200
1,200A SK	1,200, 800	700		6,300	6,300	6,300	6,300	6,300	6,300	6,300	6,300	6,300	6,300
1,200A SK, 600A SG	1,200, 800, 600	600		5,400	5,400	5,400	5,400	5,400	5,400	5,400	5,400	5,400	5,400
1,200A SK, 600A SG	800, 600	500		4,500	4,500	4,500	4,500	4,500	4,500	4,500	4,500	4,500	4,500
1,200A SK, 600A SG	800, 600	450		4,050	4,050	4,050	4,050	4,050	4,050	4,050	4,050	4,050	4,050
1,200A SK, 600A SG	800, 600, 400	400		3,600	3,600	3,600	3,600	3,600	3,600	3,600	3,600	3,600	3,600
1,200A SK, 600A SG	800, 600, 400	350		NIS	TCC	3,150	3,150	3,150	3,150	3,150	3,150	3,150	3,150
1,200A SK, 600A SG	800, 600, 400	300		NIS	NIS	TCC	2,700	2,700	2,700	2,700	2,700	2,700	2,700
600A SG	400	250		NIS	NIS	NIS	NIS	2,250	2,250	2,250	2,250	2,250	2,250
600A SG	400	225		NIS	NIS	NIS	NIS	TCC	2,025	2,025	2,025	2,025	2,025
600A SG	400	200		NIS	NIS	NIS	NIS	NIS	1,800	1,800	1,800	1,800	1,800
600A SG	400, 150	150		NIS	NIS	NIS	NIS	NIS	NIS	NIS	TCC	1,350	1,350
600A SG	150	125		NIS	NIS	NIS	NIS	NIS	NIS	NIS	NIS	NIS	1,125
600A SG	150	100		NIS	NIS	NIS	NIS	NIS	NIS	NIS	NIS	NIS	NIS
600A SG	150	80		NIS	NIS	NIS	NIS	NIS	NIS	NIS	NIS	NIS	NIS

NIS = not instantaneously selective. TCC = refer to time current curve



Electronic Trip MCCB

Panelboards, Group & Individually Mounted Switchboards

Upstream: Spectra MCCB with MVT™ Trip LSI trip type, maximum nominal pickup (X) = 10			Downstream: Spectra MCCB with RMS trip, adjustable instantaneous pickup											
Amperes			SE											
Frame	Sensor	Plug	Frame Sensor Plug	150A	150A	150A	150A	150A	150A	150A	150A	150A	150A	150A
				150A	125A	125A	100A	100A	80A	80A	60A	50A	50A	30A
				150A	125A	110A	100A	90A	80A	70A	60A	50A	40A	30A
1,200A SK	1,200	1,200		10,800	10,800	10,800	10,800	10,800	10,800	10,800	10,800	10,800	10,800	10,800
1,200A SK	1,200	1,000		9,000	9,000	9,000	9,000	9,000	9,000	9,000	9,000	9,000	9,000	9,000
1,200A SK	1,200, 800	800		7,200	7,200	7,200	7,200	7,200	7,200	7,200	7,200	7,200	7,200	7,200
1,200A SK	1,200, 800	700		6,300	6,300	6,300	6,300	6,300	6,300	6,300	6,300	6,300	6,300	6,300
1,200A SK, 600A SG	1,200, 800, 600	600		5,400	5,400	5,400	5,400	5,400	5,400	5,400	5,400	5,400	5,400	5,400
1,200A SK, 600A SG	800, 600	500		4,500	4,500	4,500	4,500	4,500	4,500	4,500	4,500	4,500	4,500	4,500
1,200A SK, 600A SG	800, 600	450		4,050	4,050	4,050	4,050	4,050	4,050	4,050	4,050	4,050	4,050	4,050
1,200A SK, 600A SG	800, 600, 400	400		3,600	3,600	3,600	3,600	3,600	3,600	3,600	3,600	3,600	3,600	3,600
1,200A SK, 600A SG	800, 600, 400	350		3,150	3,150	3,150	3,150	3,150	3,150	3,150	3,150	3,150	3,150	3,150
1,200A SK, 600A SG	800, 600, 400	300		2,700	2,700	2,700	2,700	2,700	2,700	2,700	2,700	2,700	2,700	2,700
600A SG	400	250		2,250	2,250	2,250	2,250	2,250	2,250	2,250	2,250	2,250	2,250	2,250
600A SG	400	225		TCC	2,025	2,025	2,025	2,025	2,025	2,025	2,025	2,025	2,025	2,025
600A SG	400	200		NIS	1,800	1,800	1,800	1,800	1,800	1,800	1,800	1,800	1,800	1,800
600A SG	400, 150	150		NIS	NIS	NIS	TCC	1,350	1,350	1,350	1,350	1,350	1,350	1,350
600A SG	150	125		NIS	NIS	NIS	NIS	NIS	TCC	1,125	1,125	1,125	1,125	1,125
600A SG	150	100		NIS	NIS	NIS	NIS	NIS	NIS	NIS	900	900	900	900
600A SG	150	80		NIS	NIS	NIS	NIS	NIS	NIS	NIS	NIS	720	720	720
600A SG	150	60		NIS	NIS	NIS	NIS	NIS	NIS	NIS	NIS	NIS	TCC	540

NIS = not instantaneously selective. TCC = refer to time current curve.



Electronic Trip MCCB

Panelboards, Group & Individually Mounted Switchboards

Upstream: Spectra MCCB with MVT™ Trip LSI trip type, maximum nominal pickup (X) = 10			Downstream: Thermal Magnetic MCCB							
Amperes			600A Frames, THJK, TJK, TJJ, TJD. 600A Mechanism							
Frame	Sensor	Plug	Trip	600A	500A	450A	400A	350A	300A	250A
1,200A SK	1,200	1,200		TCC	TCC	TCC	10,800	10,800	10,800	10,800
1,200A SK	1,200	1,000		NIS	TCC	TCC	TCC	TCC	9,000	9,000
1,200A SK	1,200, 800	800		NIS	NIS	NIS	TCC	TCC	TCC	7,200
1,200A SK	1,200, 800	700		NIS	NIS	NIS	NIS	TCC	TCC	TCC
1,200A SK, 600A SG	1,200, 800, 600	600		NIS	NIS	NIS	NIS	NIS	TCC	TCC
1,200A SK, 600A SG	800, 600	500		NIS	NIS	NIS	NIS	NIS	NIS	TCC
1,200A SK, 600A SG	800, 600	450		NIS	NIS	NIS	NIS	NIS	NIS	NIS
1,200A SK, 600A SG	800, 600, 400	400		NIS	NIS	NIS	NIS	NIS	NIS	NIS
1,200A SK, 600A SG	800, 600, 400	350		NIS	NIS	NIS	NIS	NIS	NIS	NIS
1,200A SK, 600A SG	800, 600, 400	300		NIS	NIS	NIS	NIS	NIS	NIS	NIS

NIS = not instantaneously selective. TCC = refer to time current curve.

Continued on next page



Electronic Trip MCCB

Panelboards, Group & Individually Mounted Switchboards

Continued from previous page

Upstream: Spectra MCCB with MVT™ Trip LSI trip type, maximum nominal pickup (X) = 10			Downstream: Thermal Magnetic MCCB									
Amperes			600A Frames, THJK, TJK, TJJ, TJD. 400A Mechanism									
Frame	Sensor	Plug	Trip	400A	350A	300A	250A	225A	200A	175A	150A	125A
1,200A SK	1,200	1,200		10,800	10,800	10,800	10,800	10,800	10,800	10,800	10,800	10,800
1,200A SK	1,200	1,000		TCC	TCC	9,000	9,000	9,000	9,000	9,000	9,000	9,000
1,200A SK	1,200, 800	800		TCC	TCC	TCC	7,200	7,200	7,200	7,200	7,200	7,200
1,200A SK	1,200, 800	700		NIS	TCC	TCC	TCC	6,300	6,300	6,300	6,300	6,300
1,200A SK, 600A SG	1,200, 800, 600	600		NIS	NIS	TCC	TCC	TCC	5,400	5,400	5,400	5,400
1,200A SK, 600A SG	800, 600	500		NIS	NIS	NIS	TCC	TCC	TCC	TCC	4,500	4,500
1,200A SK, 600A SG	800, 600	450		NIS	NIS	NIS	NIS	TCC	TCC	TCC	4,050	4,050
1,200A SK, 600A SG	800, 600, 400	400		NIS	NIS	NIS	NIS	NIS	TCC	TCC	TCC	3,600
1,200A SK, 600A SG	800, 600, 400	350		NIS	NIS	NIS	NIS	NIS	NIS	TCC	TCC	TCC
1,200A SK, 600A SG	800, 600, 400	300		NIS	NIS	NIS	NIS	NIS	NIS	NIS	TCC	TCC
600A SG	400	250		NIS	NIS	NIS	NIS	NIS	NIS	NIS	NIS	TCC
600A SG	400	225		NIS	NIS	NIS	NIS	NIS	NIS	NIS	NIS	NIS
600A SG	400	200		NIS	NIS	NIS	NIS	NIS	NIS	NIS	NIS	NIS
600A SG	400, 150	150		NIS	NIS	NIS	NIS	NIS	NIS	NIS	NIS	NIS

NIS = not instantaneously selective. TCC = refer to time current curve.

Continued on next page



Electronic Trip MCCB

Panelboards, Group & Individually Mounted Switchboards

Continued from previous page

Upstream: Spectra MCCB with MVT™ Trip LSI trip type, maximum nominal pickup (X) = 10			Downstream: Thermal Magnetic MCCB										
Amperes			225A Frame, THFK, TFK, TFJ										
Frame	Sensor	Plug	Trip	225A	200A	175A	150A	125A	110A	100A	90A	80A	70A
1,200A SK	1,200	1,200		10,800	10,800	10,800	10,800	10,800	10,800	10,800	10,800	10,800	10,800
1,200A SK	1,200	1,000		9,000	9,000	9,000	9,000	9,000	9,000	9,000	9,000	9,000	9,000
1,200A SK	1,200, 800	800		7,200	7,200	7,200	7,200	7,200	7,200	7,200	7,200	7,200	7,200
1,200A SK	1,200, 800	700		6,300	6,300	6,300	6,300	6,300	6,300	6,300	6,300	6,300	6,300
1,200A SK, 600A SG	1,200, 800, 600	600		5,400	5,400	5,400	5,400	5,400	5,400	5,400	5,400	5,400	5,400
1,200A SK, 600A SG	800, 600	500		4,500	4,500	4,500	4,500	4,500	4,500	4,500	4,500	4,500	4,500
1,200A SK, 600A SG	800, 600	450		TCC	4,050	4,050	4,050	4,050	4,050	4,050	4,050	4,050	4,050
1,200A SK, 600A SG	800, 600, 400	400		NIS	TCC	3,600	3,600	3,600	3,600	3,600	3,600	3,600	3,600
1,200A SK, 600A SG	800, 600, 400	350		NIS	NIS	TCC	3,150	3,150	3,150	3,150	3,150	3,150	3,150
1,200A SK, 600A SG	800, 600, 400	300		NIS	NIS	NIS	TCC	2,700	2,700	2,700	2,700	2,700	2,700
600A SG	400	250		NIS	NIS	NIS	NIS	TCC	2,250	2,250	2,250	2,250	2,250
600A SG	400	225		NIS	NIS	NIS	NIS	NIS	TCC	2,025	2,025	2,025	2,025
600A SG	400	200		NIS	NIS	NIS	NIS	NIS	NIS	TCC	1,800	1,800	1,800
600A SG	400, 150	150		NIS	NIS	NIS	NIS	NIS	NIS	NIS	NIS	NIS	TCC
600A SG	150	125		NIS	NIS	NIS	NIS	NIS	NIS	NIS	NIS	NIS	NIS
600A SG	150	100		NIS	NIS	NIS	NIS	NIS	NIS	NIS	NIS	NIS	NIS
600A SG	150	80		NIS	NIS	NIS	NIS	NIS	NIS	NIS	NIS	NIS	NIS

NIS = not instantaneously selective. TCC = refer to time current curve.

Continued on next page



Electronic Trip MCCB

Panelboards, Group & Individually Mounted Switchboards

Continued from previous page

Upstream: Spectra MCCB with MVT™ Trip LSI trip type, maximum nominal pickup (X) = 10			Downstream: Thermal Magnetic MCCB						
Amperes			225A Frame THQD, TQD (240V only)						
Frame	Sensor	Plug or trip	Trip	225A	200A	175A	150A	125A	100A
1,200A SK	1,200	1,200		10,800	10,800	10,800	10,800	10,800	10,800
1,200A SK	1,200	1,000		9,000	9,000	9,000	9,000	9,000	9,000
1,200A SK	1,200, 800	800		7,200	7,200	7,200	7,200	7,200	7,200
1,200A SK	1,200, 800	700		6,300	6,300	6,300	6,300	6,300	6,300
1,200A SK, 600A SG	1,200, 800, 600	600		5,400	5,400	5,400	5,400	5,400	5,400
1,200A SK, 600A SG	800, 600	500		4,500	4,500	4,500	4,500	4,500	4,500
1,200A SK, 600A SG	800, 600	450		NIS	4,050	4,050	4,050	4,050	4,050
1,200A SK, 600A SG	800, 600, 400	400		NIS	NIS	3,600	3,600	3,600	3,600
1,200A SK, 600A SG	800, 600, 400	350		NIS	NIS	NIS	3,150	3,150	3,150
1,200A SK, 600A SG	800, 600, 400	300		NIS	NIS	NIS	NIS	2,700	2,700
600A SG	400	250		NIS	NIS	NIS	NIS	NIS	2,250
600A SG	400	225		NIS	NIS	NIS	NIS	NIS	2,025
600A SG	400	200		NIS	NIS	NIS	NIS	NIS	NIS
600A SG	400, 150	150		NIS	NIS	NIS	NIS	NIS	NIS
600A SG	150	125		NIS	NIS	NIS	NIS	NIS	NIS

NIS = not instantaneously selective. TCC = refer to time current curve.



Electronic Trip MCCB

Panelboards, Group & Individually Mounted Switchboards

Upstream: Spectra MCCB with MVT™ Trip LSI trip type, maximum nominal pickup (X) = 10			Downstream: Lighting Panel Circuit Breakers										
Amperes			TEY										
Frame	Sensor	Plug	Trip	100/90A	80A	70A	60A	50-40A	35A	30A	25A	20A	15A
1,200A SK	1,200	1,200		10,800	10,800	10,800	10,800	10,800	10,800	10,800	10,800	10,800	10,800
1,200A SK	1,200	1,000		9,000	9,000	9,000	9,000	9,000	9,000	9,000	9,000	9,000	9,000
1,200A SK	1,200, 800	800		7,200	7,200	7,200	7,200	7,200	7,200	7,200	7,200	7,200	7,200
1,200A SK	1,200, 800	700		6,300	6,300	6,300	6,300	6,300	6,300	6,300	6,300	6,300	6,300
1,200A SK, 600A SG	1,200, 800, 600	600		5,400	5,400	5,400	5,400	5,400	5,400	5,400	5,400	5,400	5,400
1,200A SK, 600A SG	800, 600	500		4,500	4,500	4,500	4,500	4,500	4,500	4,500	4,500	4,500	4,500
1,200A SK, 600A SG	800, 600	450		4,050	4,050	4,050	4,050	4,050	4,050	4,050	4,050	4,050	4,050
1,200A SK, 600A SG	800, 600, 400	400		3,600	3,600	3,600	3,600	3,600	3,600	3,600	3,600	3,600	3,600
1,200A SK, 600A SG	800, 600, 400	350		NIS	3,150	3,150	3,150	3,150	3,150	3,150	3,150	3,150	3,150
1,200A SK, 600A SG	800, 600, 400	300		NIS	NIS	2,700	2,700	2,700	2,700	2,700	2,700	2,700	2,700
600A SG	400	250		NIS	NIS	NIS	2,250	2,250	2,250	2,250	2,250	2,250	2,250
600A SG	400	225		NIS	NIS	NIS	NIS	2,025	2,025	2,025	2,025	2,025	2,025
600A SG	400	200		NIS	NIS	NIS	NIS	1,800	1,800	1,800	1,800	1,800	1,800
600A SG	400, 150	150		NIS	NIS	NIS	NIS	NIS	1,350	1,350	1,350	1,350	1,350
600A SG	150	125		NIS	NIS	NIS	NIS	NIS	NIS	1,125	1,125	1,125	1,125
600A SG	150	100		NIS	NIS	NIS	NIS	NIS	NIS	NIS	900	900	900
600A SG	150	80		NIS	NIS	NIS	NIS	NIS	NIS	NIS	NIS	720	720
600A SG	150	60		NIS	NIS	NIS	NIS	NIS	NIS	NIS	NIS	NIS	540

NIS = not instantaneously selective. TCC = refer to time current curve.

Continued on next page



Electronic Trip MCCB

Panelboards, Group & Individually Mounted Switchboards

Continued from previous page

Upstream: Spectra MCCB with MVT™ Trip LSI trip type, maximum nominal pickup (X) = 10			Downstream: Lighting Panel Circuit Breakers											
Amperes			THHQB, THQB (240V only)											
Frame	Sensor	Plug	Trip	100/90A	80A	70A	60A	50A	45A	40/35A	30A	25A	20A	15A
1,200A SK	1,200	1,200		10,800	10,800	10,800	10,800	10,800	10,800	10,800	10,800	10,800	10,800	10,800
1,200A SK	1,200	1,000		9,000	9,000	9,000	9,000	9,000	9,000	9,000	9,000	9,000	9,000	9,000
1,200A SK	1,200, 800	800		7,200	7,200	7,200	7,200	7,200	7,200	7,200	7,200	7,200	7,200	7,200
1,200A SK	1,200, 800	700		6,300	6,300	6,300	6,300	6,300	6,300	6,300	6,300	6,300	6,300	6,300
1,200A SK, 600A SG	1,200, 800, 600	600		5,400	5,400	5,400	5,400	5,400	5,400	5,400	5,400	5,400	5,400	5,400
1,200A SK, 600A SG	800, 600	500		4,500	4,500	4,500	4,500	4,500	4,500	4,500	4,500	4,500	4,500	4,500
1,200A SK, 600A SG	800, 600	450		TCC	4,050	4,050	4,050	4,050	4,050	4,050	4,050	4,050	4,050	4,050
1,200A SK, 600A SG	800, 600, 400	400		NIS	3,600	3,600	3,600	3,600	3,600	3,600	3,600	3,600	3,600	3,600
1,200A SK, 600A SG	800, 600, 400	350		NIS	NIS	3,150	3,150	3,150	3,150	3,150	3,150	3,150	3,150	3,150
1,200A SK, 600A SG	800, 600, 400	300		NIS	NIS	NIS	2,700	2,700	2,700	2,700	2,700	2,700	2,700	2,700
600A SG	400	250		NIS	NIS	NIS	NIS	2,250	2,250	2,250	2,250	2,250	2,250	2,250
600A SG	400	225		NIS	NIS	NIS	NIS	NIS	2,025	2,025	2,025	2,025	2,025	2,025
600A SG	400	200		NIS	NIS	NIS	NIS	NIS	NIS	1,800	1,800	1,800	1,800	1,800
600A SG	400, 150	150		NIS	NIS	NIS	NIS	NIS	NIS	NIS	1,350	1,350	1,350	1,350
600A SG	150	125		NIS	NIS	NIS	NIS	NIS	NIS	NIS	NIS	1,125	1,125	1,125
600A SG	150	100		NIS	NIS	NIS	NIS	NIS	NIS	NIS	NIS	NIS	900	900
600A SG	150	80		NIS	NIS	NIS	NIS	NIS	NIS	NIS	NIS	NIS	NIS	720
600A SG	150	60		NIS	NIS	NIS	NIS	NIS	NIS	NIS	NIS	NIS	NIS	NIS

NIS = not instantaneously selective. TCC = refer to time current curve.



Electronic Trip MCCB

Panelboards, Group & Individually Mounted Switchboards

Upstream: Spectra MCCB with MVT™ Trips LSI trip type, maximum nominal pickup (X) = 10			Downstream: Current Limiting Circuit Breaker for Lighting Panels										
Amperes			Record Plus 100A FB										
Frame	Sensor	Plug	Trip	100/90A	80A	70A	60A	50A	45A	40/35A	30A	25A	20/15A
1,200A SK	1,200	1,200		25,900	25,900	25,900	25,900	25,900	25,900	25,900	25,900	25,900	25,900
1,200A SK	1,200	1,000		9,000	9,000	9,000	9,000	9,000	9,000	9,000	9,000	9,000	9,000
1,200A SK	1,200, 800	800		7,200	7,200	7,200	7,200	7,200	7,200	7,200	7,200	7,200	7,200
1,200A SK	1,200, 800	700		6,300	6,300	6,300	6,300	6,300	6,300	6,300	6,300	6,300	6,300
1,200A SK, 600A SG	1,200, 800, 600	600		5,400	5,400	5,400	5,400	5,400	5,400	5,400	5,400	5,400	5,400
1,200A SK, 600A SG	800, 600	500		4,500	4,500	4,500	4,500	4,500	4,500	4,500	4,500	4,500	4,500
1,200A SK, 600A SG	800, 600	450		TCC	4,050	4,050	4,050	4,050	4,050	4,050	4,050	4,050	4,050
1,200A SK, 600A SG	800, 600, 400	400		NIS	3,600	3,600	3,600	3,600	3,600	3,600	3,600	3,600	3,600
1,200A SK, 600A SG	800, 600, 400	350		NIS	NIS	3,150	3,150	3,150	3,150	3,150	3,150	3,150	3,150
1,200A SK, 600A SG	800, 600, 400	300		NIS	NIS	NIS	2,700	2,700	2,700	2,700	2,700	2,700	2,700
600A SG	400	250		NIS	NIS	NIS	NIS	2,250	2,250	2,250	2,250	2,250	2,250
600A SG	400	225		NIS	NIS	NIS	NIS	NIS	2,025	2,025	2,025	2,025	2,025
600A SG	400	200		NIS	NIS	NIS	NIS	NIS	NIS	1,800	1,800	1,800	1,800
600A SG	400, 150	150		NIS	NIS	NIS	NIS	NIS	NIS	NIS	1,350	1,350	1,350
600A SG	150	125		NIS	NIS	NIS	NIS	NIS	NIS	NIS	NIS	1,125	1,125
600A SG	150	100		NIS	NIS	NIS	NIS	NIS	NIS	NIS	NIS	NIS	900
600A SG	150	80		NIS	NIS	NIS	NIS	NIS	NIS	NIS	NIS	NIS	TCC
600A SG	150	60		NIS	NIS	NIS	NIS	NIS	NIS	NIS	NIS	NIS	NIS

NIS = not instantaneously selective. TCC = refer to time current curve.



Electronic Trip MCCB

Panelboards, Group & Individually Mounted Switchboards

Upstream: Spectra MCCB with MVT™ Trip LSI trip type, maximum nominal pickup (X) = 10			Downstream: Circuit breakers for motor control application with fused limiters					
Amperes			TECL					
Frame	Sensor	Plug or trip	Trip	150A	100A	50A	30A	15, 7 & 3A
1,200A SK	1,200	1,200		13,658	30,432	100,000	100,000	100,000
1,200A SK	1,200	1,000		9,000	17,667	59,300	100,000	100,000
1,200A SK	1,200, 800	800		7,200	9,081	29,900	100,000	100,000
1,200A SK	1,200, 800	700		6,300	6,300	19,900	97,300	100,000
1,200A SK, 600A SG	1,200, 800, 600	600		5,400	5,400	12,400	61,000	100,000
1,200A SK, 600A SG	800, 600	500		4,500	4,500	7,100	35,100	100,000
1,200A SK, 600A SG	800, 600	450		4,050	4,050	5,100	25,500	100,000
1,200A SK, 600A SG	800, 600, 400	400		3,600	3,600	3,600	17,900	84,700
1,200A SK, 600A SG	800, 600, 400	350		3,150	3,150	3,150	11,900	55,500
1,200A SK, 600A SG	800, 600, 400	300		2,700	2,700	2,700	7,500	34,000
600A SG	400	250		TCC	2,250	2,250	4,300	19,100
600A SG	400	225		TCC	2,025	2,025	3,100	13,700
600A SG	400	200		NIS	1,800	1,800	2,200	9,400
600A SG	400, 150	150		NIS	TCC	1,350	1,350	3,800

NIS = not instantaneously selective. TCC = refer to time current curve.



Electronic Trip MCCB

Panelboards, Group & Individually Mounted Switchboards

Upstream: Spectra MCCB with MVT™ Trip LSI trip type, maximum nominal pickup (X) = 10			Downstream: Circuit breaker used in switchboards, power distribution panels and lighting panels (400A max in lighting panels)		
Amperes			Record Plus G Frame		
Frame	Sensor	Plug or trip	600A Sensor, 600-350A Plugs	400A Sensor, 400-175A Plugs	250A Sensor, 250-125A Plugs
1,200A SK	1,200	1,200	10,800	10,800	10,800
1,200A SK	1,200	1,000	9,000	9,000	9,000
1,200A SK	1,200, 800	800	7,200	7,200	7,200
1,200A SK	1,200, 800	700	NIS	6,300	6,300
1,200A SK, 600A SG	1,200, 800, 600	600	NIS	5,400	5,400
1,200A SK, 600A SG	800, 600	500	NIS	4,500	4,500
1,200A SK, 600A SG	800, 600	450	NIS	NIS	4,050
1,200A SK, 600A SG	800, 600, 400	400	NIS	NIS	3,600
1,200A SK, 600A SG	800, 600, 400	350	NIS	NIS	3,150
1,200A SK, 600A SG	800, 600, 400	300	NIS	NIS	2,700
600A SG	400	250	NIS	NIS	NIS
600A SG	400	225	NIS	NIS	NIS
600A SG	400	200	NIS	NIS	NIS
600A SG	400, 150	150	NIS	NIS	NIS

NIS = not instantaneously selective. TCC = refer to time current curve.



Spectra RMS Mains

Upstream: Spectra RMS adjustable instantaneous trips				Downstream: Spectra MCCB with adjustable instantaneous trips								
Frame	Amperes		Max. Inst. Pickup (X Plug)	SK								
	Sensor	Plug or trip		Plug	1,200A	1,000A	800A	700A	600A	500A	400A	300A
SK	1,200	1,200	10	NIS	NIS	TCC	9,772	9,772	9,772	9,772	9,772	
	1,200	1,000	10	NIS	NIS	NIS	NIS	8,144	8,144	8,144	8,144	
	800	800	10	NIS	NIS	NIS	NIS	NIS	6,964	6,964	6,964	
	800	700	10	NIS	NIS	NIS	NIS	NIS	NIS	5,936	5,936	
	800	600	10.5	NIS	NIS	NIS	NIS	NIS	NIS	TCC	4,956	
	800	500	10.5	NIS	NIS	NIS	NIS	NIS	NIS	NIS	4,016	
	800	400	10.5	NIS	NIS	NIS	NIS	NIS	NIS	NIS	NIS	

NIS = not instantaneously selective. TCC = refer to time current curve.



Spectra RMS Mains

Upstream: Spectra RMS adjustable instantaneous trips				Downstream: Spectra MCCB with adjustable instantaneous trips											
Frame	Amperes		Max. Inst. Pickup (X Plug)	Plug	SG										
	Sensor	Plug or trip			600A	500A	450A	400A	350A	300A	250A	200A	175A	150A	125A
SK	1,200	1,200	10		9,772	9,772	9,772	9,772	9,772	9,772	9,772	9,772	9,772	9,772	9,772
	1,200	1,000	10		8,144	8,144	8,144	8,144	8,144	8,144	8,144	8,144	8,144	8,144	8,144
	800	800	10		NIS	6,964	6,964	6,964	6,964	6,964	6,964	6,964	6,964	6,964	6,964
	800	700	10		NIS	NIS	TCC	5,936	5,936	5,936	5,936	5,936	5,936	5,936	5,936
	800	600	10.5		NIS	NIS	NIS	TCC	4,956	4,956	4,956	4,956	4,956	4,956	4,956
	800	500	10.5		NIS	NIS	NIS	NIS	NIS	4,016	4,016	4,016	4,016	4,016	4,016
	800	400	10.5		NIS	NIS	NIS	NIS	NIS	NIS	3,212	3,212	3,212	3,212	3,212
	800	300	10.5		NIS	NIS	NIS	NIS	NIS	NIS	NIS	TCC	2,412	2,412	2,412
SG	600	600	10		NIS	NIS	NIS	TCC	4,860	4,860	4,860	4,860	4,860	4,860	4,860
	600	500	10		NIS	NIS	NIS	NIS	NIS	4,048	4,048	4,048	4,048	4,048	4,048
	600	450	10		NIS	NIS	NIS	NIS	NIS	TCC	3,644	3,644	3,644	3,644	3,644
	400	400	10		NIS	NIS	NIS	NIS	NIS	NIS	3,264	3,264	3,264	3,264	3,264
	400	350	10		NIS	NIS	NIS	NIS	NIS	NIS	NIS	2,856	2,856	2,856	2,856
	400	300	10		NIS	NIS	NIS	NIS	NIS	NIS	NIS	TCC	2,448	2,448	2,448
	400	250	10		NIS	NIS	NIS	NIS	NIS	NIS	NIS	NIS	NIS	2,040	2,040
	400	200	10		NIS	NIS	NIS	NIS	NIS	NIS	NIS	NIS	NIS	NIS	1,632
	400	175	10		NIS	NIS	NIS	NIS	NIS	NIS	NIS	NIS	NIS	NIS	NIS
	400	150	10		NIS	NIS	NIS	NIS	NIS	NIS	NIS	NIS	NIS	NIS	NIS

NIS = not instantaneously selective. TCC = refer to time current curve.



Spectra RMS Mains

Upstream: Spectra RMS adjustable instantaneous trips				Downstream: Spectra MCCB with adjustable instantaneous trips										
Frame	Amperes		Max. Inst. Pickup (X Plug)	Plug	SF									
	Sensor	Plug or trip			250A	225A	200A	175A	150A	125A	110A	100A	90A	70A
SK	1,200	1,200	10		9,772	9,772	9,772	9,772	9,772	9,772	9,772	9,772	9,772	9,772
	1,200	1,000	10		8,144	8,144	8,144	8,144	8,144	8,144	8,144	8,144	8,144	8,144
	800	800	10		6,964	6,964	6,964	6,964	6,964	6,964	6,964	6,964	6,964	6,964
	800	700	10		5,936	5,936	5,936	5,936	5,936	5,936	5,936	5,936	5,936	5,936
	800	600	10.5		4,956	4,956	4,956	4,956	4,956	4,956	4,956	4,956	4,956	4,956
	800	500	10.5		4,016	4,016	4,016	4,016	4,016	4,016	4,016	4,016	4,016	4,016
	800	400	10.5		3,212	3,212	3,212	3,212	3,212	3,212	3,212	3,212	3,212	3,212
	800	300	10.5		NIS	NIS	TCC	2,412	2,412	2,412	2,412	2,412	2,412	2,412
SG	600	600	10		4,860	4,860	4,860	4,860	4,860	4,860	4,860	4,860	4,860	4,860
	600	500	10		4,048	4,048	4,048	4,048	4,048	4,048	4,048	4,048	4,048	4,048
	600	450	10		3,644	3,644	3,644	3,644	3,644	3,644	3,644	3,644	3,644	3,644
	400	400	10		3,264	3,264	3,264	3,264	3,264	3,264	3,264	3,264	3,264	3,264
	400	350	10		NIS	TCC	2,856	2,856	2,856	2,856	2,856	2,856	2,856	2,856
	400	300	10		NIS	NIS	TCC	2,448	2,448	2,448	2,448	2,448	2,448	2,448
	400	250	10		NIS	NIS	NIS	NIS	2,040	2,040	2,040	2,040	2,040	2,040
	400	200	10		NIS	NIS	NIS	NIS	NIS	1,632	1,632	1,632	1,632	1,632
	400	175	10		NIS	NIS	NIS	NIS	NIS	NIS	TCC	1,428	1,428	1,428
	400	150	10		NIS	NIS	NIS	NIS	NIS	NIS	NIS	TCC	1,224	1,224
	400	125	10		NIS	NIS	NIS	NIS	NIS	NIS	NIS	NIS	NIS	1,020

NIS = not instantaneously selective. TCC = refer to time current curve.

Continued on next page



Spectra RMS Mains

Continued from previous page

Upstream: Spectra RMS adjustable instantaneous trips				Downstream: Spectra MCCB with adjustable instantaneous trips										
Frame	Amperes		Max. Inst. Pickup (X Plug)	SF										
	Sensor	Plug or trip		Plug	250A	225A	200A	175A	150A	125A	110A	100A	90A	70A
SF	250	250	10		NIS	NIS	NIS	NIS	2,000	2,000	2,000	2,000	2,000	2,000
	250	225	10		NIS	NIS	NIS	NIS	TCC	1,800	1,800	1,800	1,800	1,800
	250	200	10		NIS	NIS	NIS	NIS	NIS	1,600	1,600	1,600	1,600	1,600
	250	175	10		NIS	NIS	NIS	NIS	NIS	NIS	TCC	1,400	1,400	1,400
	250	150	10		NIS	NIS	NIS	NIS	NIS	NIS	NIS	TCC	1,200	1,200
	250	125	10		NIS	NIS	NIS	NIS	NIS	NIS	NIS	NIS	NIS	1,000
	250	110	10		NIS	NIS	NIS	NIS	NIS	NIS	NIS	NIS	NIS	TCC
	250	100	10		NIS	NIS	NIS	NIS	NIS	NIS	NIS	NIS	NIS	NIS
250	90	10		NIS	NIS	NIS	NIS	NIS	NIS	NIS	NIS	NIS	NIS	

NIS = not instantaneously selective. TCC = refer to time current curve.



Spectra RMS Mains

Upstream: Spectra RMS adjustable instantaneous trips				Downstream: Spectra MCCB with adjustable instantaneous trips											
Frame	Amperes		Max. Inst. Pickup (X Plug)	Plug	SE										
	Sensor	Plug or trip			150A	125A	110A	100A	90A	80A	70A	60A	50A	40A	30-15A
SK	1,200	1,200	10		9,772	9,772	9,772	9,772	9,772	9,772	9,772	9,772	9,772	9,772	9,772
	1,200	1,000	10		8,144	8,144	8,144	8,144	8,144	8,144	8,144	8,144	8,144	8,144	8,144
	800	800	10		6,964	6,964	6,964	6,964	6,964	6,964	6,964	6,964	6,964	6,964	6,964
	800	700	10		5,936	5,936	5,936	5,936	5,936	5,936	5,936	5,936	5,936	5,936	5,936
	800	600	10.5		4,956	4,956	4,956	4,956	4,956	4,956	4,956	4,956	4,956	4,956	4,956
	800	500	10.5		4,016	4,016	4,016	4,016	4,016	4,016	4,016	4,016	4,016	4,016	4,016
	800	400	10.5		3,212	3,212	3,212	3,212	3,212	3,212	3,212	3,212	3,212	3,212	3,212
	800	300	10.5		2,412	2,412	2,412	2,412	2,412	2,412	2,412	2,412	2,412	2,412	2,412
SG	600	600	10		4,860	4,860	4,860	4,860	4,860	4,860	4,860	4,860	4,860	4,860	4,860
	600	500	10		4,048	4,048	4,048	4,048	4,048	4,048	4,048	4,048	4,048	4,048	4,048
	600	450	10		3,644	3,644	3,644	3,644	3,644	3,644	3,644	3,644	3,644	3,644	3,644
	400	400	10		3,264	3,264	3,264	3,264	3,264	3,264	3,264	3,264	3,264	3,264	3,264
	400	350	10		2,856	2,856	2,856	2,856	2,856	2,856	2,856	2,856	2,856	2,856	2,856
	400	300	10		2,448	2,448	2,448	2,448	2,448	2,448	2,448	2,448	2,448	2,448	2,448
	400	250	10		2,040	2,040	2,040	2,040	2,040	2,040	2,040	2,040	2,040	2,040	2,040
	400	200	10		NIS	1,632	1,632	1,632	1,632	1,632	1,632	1,632	1,632	1,632	1,632
	400	175	10		NIS	NIS	TCC	1,428	1,428	1,428	1,428	1,428	1,428	1,428	1,428
	400	150	10		NIS	NIS	NIS	TCC	1,224	1,224	1,224	1,224	1,224	1,224	1,224
	400	125	10		NIS	NIS	NIS	NIS	NIS	TCC	1,020	1,020	1,020	1,020	1,020

NIS = not instantaneously selective. TCC = refer to time current curve.

Continued on next page



Spectra RMS Mains

Continued from previous page

Upstream: Spectra RMS adjustable instantaneous trips				Downstream: Spectra MCCB with adjustable instantaneous trips											
Frame	Amperes		Max. Inst. Pickup (X Plug)	Plug	SE										
	Sensor	Plug or trip			150A	125A	110A	100A	90A	80A	70A	60A	50A	40A	30-15A
SF	250	250	10		2,000	2,000	2,000	2,000	2,000	2,000	2,000	2,000	2,000	2,000	2,000
	250	225	10		TCC	1,800	1,800	1,800	1,800	1,800	1,800	1,800	1,800	1,800	1,800
	250	200	10		NIS	1,600	1,600	1,600	1,600	1,600	1,600	1,600	1,600	1,600	1,600
	250	175	10		NIS	NIS	TCC	1,400	1,400	1,400	1,400	1,400	1,400	1,400	1,400
	250	150	10		NIS	NIS	NIS	TCC	1,200	1,200	1,200	1,200	1,200	1,200	1,200
	250	125	10		NIS	NIS	NIS	NIS	NIS	TCC	1,000	1,000	1,000	1,000	1,000
	250	110	10		NIS	NIS	NIS	NIS	NIS	NIS	TCC	880	880	880	880
	250	100	10		NIS	NIS	NIS	NIS	NIS	NIS	NIS	800	800	800	800
	250	90	10		NIS	NIS	NIS	NIS	NIS	NIS	NIS	TCC	720	720	720
	250	70	10		NIS	NIS	NIS	NIS	NIS	NIS	NIS	NIS	NIS	560	560
SE	150	150	14		NIS	NIS	NIS	TCC	1,593	1,593	1,593	1,593	1,593	1,593	1,593
	125	125	13		NIS	NIS	NIS	NIS	NIS	TCC	1,312	1,312	1,312	1,312	1,312
	125	110	13		NIS	NIS	NIS	NIS	NIS	NIS	TCC	1,141	1,141	1,141	1,141
	100	100	12.5		NIS	NIS	NIS	NIS	NIS	NIS	NIS	1,024	1,024	1,024	1,024
	100	90	12.5		NIS	NIS	NIS	NIS	NIS	NIS	NIS	TCC	910	910	910
	80	80	12.5		NIS	NIS	NIS	NIS	NIS	NIS	NIS	NIS	799	799	799
	80	70	12.5		NIS	NIS	NIS	NIS	NIS	NIS	NIS	NIS	NIS	690	690
	60	60	12.5		NIS	NIS	NIS	NIS	NIS	NIS	NIS	NIS	NIS	TCC	622
	50	50	12.5		NIS	NIS	NIS	NIS	NIS	NIS	NIS	NIS	NIS	NIS	510
	50	40	12.5		NIS	NIS	NIS	NIS	NIS	NIS	NIS	NIS	NIS	NIS	NIS
30	30	13		NIS	NIS	NIS	NIS	NIS	NIS	NIS	NIS	NIS	NIS	NIS	

NIS = not instantaneously selective. TCC = refer to time current curve.



Spectra RMS Mains

Upstream: Spectra RMS adjustable instantaneous trips				Downstream: Lighting panel circuit breakers									
Amperes			Max. Inst. Pickup (X Plug)	TEY									
Frame	Sensor	Plug		Trip	100A	90A	80A	70A	60A	50/45A	40A	35A	30-15A
SK	1,200	1,200	10	9,772	9,772	9,772	9,772	9,772	9,772	9,772	9,772	9,772	9,772
	1,200	1,000	10	8,144	8,144	8,144	8,144	8,144	8,144	8,144	8,144	8,144	8,144
	800	800	10	6,964	6,964	6,964	6,964	6,964	6,964	6,964	6,964	6,964	6,964
	800	700	10	5,936	5,936	5,936	5,936	5,936	5,936	5,936	5,936	5,936	5,936
	800	600	10.5	4,956	4,956	4,956	4,956	4,956	4,956	4,956	4,956	4,956	4,956
	800	500	10.5	4,518	4,518	4,518	4,518	4,518	4,518	4,518	4,518	4,518	4,518
	800	400	10.5	3,212	3,212	3,212	3,212	3,212	3,212	3,212	3,212	3,212	3,212
	800	300	10.5	NIS	NIS	NIS	2,412	2,412	2,412	2,412	2,412	2,412	2,412
SG	600	600	10	4,860	4,860	4,860	4,860	4,860	4,860	4,860	4,860	4,860	4,860
	600	500	10	4,048	4,048	4,048	4,048	4,048	4,048	4,048	4,048	4,048	4,048
	600	450	10	3,644	3,644	3,644	3,644	3,644	3,644	3,644	3,644	3,644	3,644
	400	400	10	3,264	3,264	3,264	3,264	3,264	3,264	3,264	3,264	3,264	3,264
	400	350	10	NIS	NIS	2,856	2,856	2,856	2,856	2,856	2,856	2,856	2,856
	400	300	10	NIS	NIS	NIS	2,448	2,448	2,448	2,448	2,448	2,448	2,448
	400	250	10	NIS	NIS	NIS	NIS	2,040	2,040	2,040	2,040	2,040	2,040
	400	200	10	NIS	NIS	NIS	NIS	NIS	1,632	1,632	1,632	1,632	1,632
	400	175	10	NIS	NIS	NIS	NIS	NIS	NIS	1,428	1,428	1,428	1,428
	400	150	10	NIS	NIS	NIS	NIS	NIS	NIS	NIS	1,224	1,224	1,224
	400	125	10	NIS	NIS	NIS	NIS	NIS	NIS	NIS	NIS	NIS	1,020

NIS = not instantaneously selective. TCC = refer to time current curve.

Continued on next page



Spectra RMS Mains

Continued from previous page

Upstream: Spectra RMS adjustable instantaneous trips				Downstream: Lighting panel circuit breakers									
Amperes			Max. Inst. Pickup (X Plug)	TEY									
Frame	Sensor	Plug		Trip	100-70A	60A	50/45A	40A	35A	30A	25A	20A	15A
SF	250	250	10	NIS	2,000	2,000	2,000	2,000	2,000	2,000	2,000	2,000	2,000
	250	225	10	NIS	NIS	1,800	1,800	1,800	1,800	1,800	1,800	1,800	1,800
	250	200	10	NIS	NIS	1,600	1,600	1,600	1,600	1,600	1,600	1,600	1,600
	250	175	10	NIS	NIS	NIS	1,400	1,400	1,400	1,400	1,400	1,400	1,400
	250	150	10	NIS	NIS	NIS	NIS	1,200	1,200	1,200	1,200	1,200	1,200
	250	125	10	NIS	NIS	NIS	NIS	NIS	1,000	1,000	1,000	1,000	1,000
	250	110	10	NIS	NIS	NIS	NIS	NIS	NIS	880	880	880	880
	250	100	10	NIS	NIS	NIS	NIS	NIS	NIS	800	800	800	800
	250	90	10	NIS	NIS	NIS	NIS	NIS	NIS	NIS	NIS	720	720
SE	250	70	10	NIS	NIS	NIS	NIS	NIS	NIS	NIS	NIS	NIS	560
	150	150	14	NIS	NIS	NIS	NIS	1,593	1,593	1,593	1,593	1,593	1,593
	125	125	13	NIS	NIS	NIS	NIS	NIS	1,312	1,312	1,312	1,312	1,312
	125	110	13	NIS	NIS	NIS	NIS	NIS	NIS	1,141	1,141	1,141	1,141
	100	100	12.5	NIS	NIS	NIS	NIS	NIS	NIS	1,024	1,024	1,024	1,024
	100	90	12.5	NIS	NIS	NIS	NIS	NIS	NIS	NIS	910	910	910
	80	80	12.5	NIS	NIS	NIS	NIS	NIS	NIS	NIS	799	799	799
	80	70	12.5	NIS	NIS	NIS	NIS	NIS	NIS	NIS	NIS	690	690
	60	60	12.5	NIS	NIS	NIS	NIS	NIS	NIS	NIS	NIS	622	622
	50	50	12.5	NIS	NIS	NIS	NIS	NIS	NIS	NIS	NIS	NIS	NIS
50	40	12.5	NIS	NIS	NIS	NIS	NIS	NIS	NIS	NIS	NIS	NIS	
30	30	13	NIS	NIS	NIS	NIS	NIS	NIS	NIS	NIS	NIS	NIS	

NIS = not instantaneously selective. TCC = refer to time current curve.



Spectra RMS Mains

Upstream: Spectra RMS adjustable instantaneous trips				Downstream: Lighting panel circuit breakers										
Amperes			Max. Inst. Pickup (X Plug)	THQB, THHQB (240V only)										
Frame	Sensor	Plug or trip		Trip	100A	90A	80A	70A	60A	50/45A	40A	35A	30A	25-15A
SK	1,200	1,200	10	9,772	9,772	9,772	9,772	9,772	9,772	9,772	9,772	9,772	9,772	9,772
	1,200	1,000	10	8,144	8,144	8,144	8,144	8,144	8,144	8,144	8,144	8,144	8,144	8,144
	800	800	10	6,964	6,964	6,964	6,964	6,964	6,964	6,964	6,964	6,964	6,964	6,964
	800	700	10	5,936	5,936	5,936	5,936	5,936	5,936	5,936	5,936	5,936	5,936	5,936
	800	600	10.5	4,956	4,956	4,956	4,956	4,956	4,956	4,956	4,956	4,956	4,956	4,956
	800	500	10.5	4,518	4,518	4,518	4,518	4,518	4,518	4,518	4,518	4,518	4,518	4,518
	800	400	10.5	NIS	NIS	3,212	3,212	3,212	3,212	3,212	3,212	3,212	3,212	3,212
	800	300	10.5	NIS	NIS	NIS	NIS	2,412	2,412	2,412	2,412	2,412	2,412	2,412
SG	600	600	10	4,860	4,860	4,860	4,860	4,860	4,860	4,860	4,860	4,860	4,860	4,860
	600	500	10	4,048	4,048	4,048	4,048	4,048	4,048	4,048	4,048	4,048	4,048	4,048
	600	450	10	NIS	3,644	3,644	3,644	3,644	3,644	3,644	3,644	3,644	3,644	3,644
	400	400	10	NIS	NIS	3,264	3,264	3,264	3,264	3,264	3,264	3,264	3,264	3,264
	400	350	10	NIS	NIS	NIS	2,856	2,856	2,856	2,856	2,856	2,856	2,856	2,856
	400	300	10	NIS	NIS	NIS	NIS	2,448	2,448	2,448	2,448	2,448	2,448	2,448
	400	250	10	NIS	NIS	NIS	NIS	NIS	2,040	2,040	2,040	2,040	2,040	2,040
	400	200	10	NIS	NIS	NIS	NIS	NIS	NIS	1,632	1,632	1,632	1,632	1,632
	400	175	10	NIS	NIS	NIS	NIS	NIS	NIS	NIS	1,428	1,428	1,428	1,428
	400	150	10	NIS	NIS	NIS	NIS	NIS	NIS	NIS	NIS	1,224	1,224	1,224
400	125	10	NIS	NIS	NIS	NIS	NIS	NIS	NIS	NIS	NIS	NIS	1,020	

NIS = not instantaneously selective. TCC = refer to time current curve.

Continued on next page



Spectra RMS Mains

Continued from previous page

Upstream: Spectra RMS adjustable instantaneous trips				Downstream: Lighting panel circuit breakers									
Amperes			Max. Inst. Pickup (X Plug)	THQB, THHQB (240V only)									
Frame	Sensor	Plug or trip		Trip	100-60A	50A	45A	40A	35A	30A	25A	20A	15A
SF	250	250	10	NIS	2,000	2,000	2,000	2,000	2,000	2,000	2,000	2,000	2,000
	250	225	10	NIS	NIS	1,800	1,800	1,800	1,800	1,800	1,800	1,800	1,800
	250	200	10	NIS	NIS	NIS	1,600	1,600	1,600	1,600	1,600	1,600	1,600
	250	175	10	NIS	NIS	NIS	NIS	1,400	1,400	1,400	1,400	1,400	1,400
	250	150	10	NIS	NIS	NIS	NIS	NIS	1,200	1,200	1,200	1,200	1,200
	250	125	10	NIS	NIS	NIS	NIS	NIS	NIS	1,000	1,000	1,000	1,000
	250	110	10	NIS	NIS	NIS	NIS	NIS	NIS	NIS	NIS	880	880
	250	100	10	NIS	NIS	NIS	NIS	NIS	NIS	NIS	NIS	800	800
	250	90	10	NIS	NIS	NIS	NIS	NIS	NIS	NIS	NIS	NIS	720
SE	150	150	14	NIS	NIS	NIS	NIS	NIS	NIS	1,593	1,593	1,593	1,593
	125	125	13	NIS	NIS	NIS	NIS	NIS	NIS	NIS	1,312	1,312	1,312
	125	110	13	NIS	NIS	NIS	NIS	NIS	NIS	NIS	NIS	1,141	1,141
	100	100	12.5	NIS	NIS	NIS	NIS	NIS	NIS	NIS	NIS	1,024	1,024
	100	90	12.5	NIS	NIS	NIS	NIS	NIS	NIS	NIS	NIS	NIS	910
	80	80	12.5	NIS	NIS	NIS	NIS	NIS	NIS	NIS	NIS	NIS	799
	80	70	12.5	NIS	NIS	NIS	NIS	NIS	NIS	NIS	NIS	NIS	NIS
	60	60	12.5	NIS	NIS	NIS	NIS	NIS	NIS	NIS	NIS	NIS	NIS
	50	50	12.5	NIS	NIS	NIS	NIS	NIS	NIS	NIS	NIS	NIS	NIS
	50	40	12.5	NIS	NIS	NIS	NIS	NIS	NIS	NIS	NIS	NIS	NIS
30	30	13	NIS	NIS	NIS	NIS	NIS	NIS	NIS	NIS	NIS	NIS	

NIS = not instantaneously selective. TCC = refer to time current curve.



Spectra RMS Mains

Upstream: Spectra RMS adjustable instantaneous trips				Downstream: Circuit breakers for motor control applications with fused limiters					
Frame	Amperes		Max. Inst. Pickup (X Plug)	Trip	TECL				
	Sensor	Plug or trip			150A	100A	50A	30A	15-3A
SK	1,200	1,000	10		9,772	22,583	76,300	100,000	100,000
	800	800	10		8,144	13,113	43,700	100,000	100,000
	800	700	10		6,964	8,222	27,000	100,000	100,000
	800	600	10.5		5,936	5,936	16,600	81,200	100,000
	800	500	10.5		4,956	4,956	9,500	47,000	100,000
	800	400	10.5		4,016	4,016	5,000	24,900	100,000
	800	300	10.5		3,212	3,212	3,212	12,600	59,000
SG	600	600	10		2,412	2,412	2,412	5,300	23,800
	600	500	10		4,860	4,860	9,000	44,300	100,000
	600	450	10		4,048	4,048	5,100	25,500	100,000
	400	400	10		3,644	3,644	3,700	18,500	88,000
	400	350	10		3,264	3,264	3,264	13,300	62,100
	400	300	10		2,856	2,856	2,856	8,900	40,600
	400	250	10		2,448	2,448	2,448	5,500	24,900
	400	200	10		TCC	2,040	2,040	3,200	14,000
	400	175	10		NIS	1,632	1,632	1,632	6,900
	400	150	10		NIS	1,428	1,428	1,428	4,500
	400	125	10		NIS	TCC	1,224	1,224	2,800

NIS = not instantaneously selective. TCC = refer to time current curve.

Continued on next page



Spectra RMS Mains

Continued from previous page

Upstream: Spectra RMS adjustable instantaneous trips				Downstream: Circuit breakers for motor control applications with fused limiters					
Frame	Amperes		Max. Inst. Pickup (X Plug)	Trip	TECL				
	Sensor	Plug or trip			150A	100A	50A	30A	15-3A
SF	250	250	10	TCC	2,000	2,000	3,000	13,100	
	250	225	10	TCC	1,800	1,800	2,200	9,400	
	250	200	10	NIS	1,600	1,600	1,600	6,500	
	250	175	10	NIS	1,400	1,400	1,400	4,200	
	250	150	10	NIS	TCC	1,200	1,200	2,600	
	250	125	10	NIS	NIS	1,000	1,000	1,500	
	250	110	10	NIS	NIS	880	880	1,000	
	250	100	10	NIS	NIS	800	800	700	
	250	90	10	NIS	NIS	720	720	720	
	250	70	10	NIS	NIS	NIS	560	560	
SE	150	150	14	NIS	TCC	1,593	1,593	6,400	
	125	125	13	NIS	NIS	1,312	1,312	3,500	
	125	110	13	NIS	NIS	1,141	1,141	2,200	
	100	100	12.5	NIS	NIS	1,024	1,024	1,600	
	100	90	12.5	NIS	NIS	910	910	1,100	
	80	80	12.5	NIS	NIS	TCC	799	799	
	80	70	12.5	NIS	NIS	NIS	690	690	
	60	60	12.5	NIS	NIS	NIS	622	622	
	50	50	12.5	NIS	NIS	NIS	TCC	510	
	50	40	12.5	NIS	NIS	NIS	NIS	401	
30	30	13	NIS	NIS	NIS	NIS	332		

NIS = not instantaneously selective. TCC = refer to time current curve



Thermal Magnetic MCCB

Type	Amperes		Max. Inst. Pickup (X Plug)	Trip	Downstream: 225A Frame THQD, TQD (240V only)					
	Frame	Trip			225A	200A	175A	150A	125A	100A
TK, THK	1,200	1,200	8		7,968	7,968	7,968	7,968	7,968	7,968
		1000	10		8,000	8,000	8,000	8,000	8,000	8,000
		800	9		5,120	5,120	5,120	5,120	5,120	5,120
		700	10		5,096	5,096	5,096	5,096	5,096	5,096
		600	10		4,800	4,800	4,800	4,800	4,800	4,800
		500	10		4,000	4,000	4,000	4,000	4,000	4,000
		450	10		TCC	3,600	3,600	3,600	3,600	3,600
		400	10		TCC	TCC	3,200	3,200	3,200	3,200
		350	10		NIS	NIS	TCC	2,800	2,800	2,800
		300	10		NIS	NIS	NIS	TCC	2,400	2,400
TJ, THJ	600	600	10		4,800	4,800	4,800	4,800	4,800	4,800
		500	10		4,000	4,000	4,000	4,000	4,000	4,000
		450	10		TCC	3,600	3,600	3,600	3,600	3,600
		400	10		TCC	TCC	3,200	3,200	3,200	3,200
		350	10		NIS	NIS	TCC	2,800	2,800	2,800
		300	10		NIS	NIS	NIS	TCC	2,400	2,400
		250	10		NIS	NIS	NIS	NIS	TCC	2,000
		225	10		NIS	NIS	NIS	NIS	TCC	1,800
125	10		NIS	NIS	NIS	NIS	NIS	NIS		

NIS = not instantaneously selective. TCC = refer to time current curve.



Thermal Magnetic MCCB

Type	Amperes		Max. Inst. Pickup (X Plug)	Downstream: Lighting Panel Circuit Breakers			
	Frame	Trip		TEY 480/277 and 240V, THQB and THHQB 240V only			
				Trip	100-80A	70-45A	40-15A
TK, THK	1200	1,200	8		7,968	7,968	7,968
		1,000	10		8,000	8,000	8,000
		800	9		5,120	5,120	5,120
		700	10		5,096	5,096	5,096
		600	10		4,800	4,800	4,800
		500	10		4,000	4,000	4,000
		450	10		3,600	3,600	3,600
		400	10		3,200	3,200	3,200
		350	10		2,800	2,800	2,800
		300	10		2,400	2,400	2,400
TJ, THJ	600	600	10		4,800	4,800	4,800
		500	10		4,000	4,000	4,000
		450	10		3,600	3,600	3,600
		400	10		3,200	3,200	3,200
		350	10		2,800	2,800	2,800
		300	10		2,400	2,400	2,400
		250	10		TCC	2,000	2,000
		225	10		TCC	1,800	1,800
		125	10		NIS	TCC	1,000

NIS = not instantaneously selective. TCC = refer to time current curve.

Continued on next page



Thermal Magnetic MCCB

Continued from previous page

Type	Amperes		Max. Inst. Pickup (X Plug)	Downstream: Lighting Panel Circuit Breakers TEY 480/277 and 240V													
	Frame	Trip		Trip	100A	90A	80A	70A	60A	50A	45A	40A	35A	30A	25A	20A	15A
TF, THF	225	225	10	TCC	TCC	TCC	1,800	1,800	1,800	1,800	1,800	1,800	1,800	1,800	1,800	1,800	1,800
		200	10	NIS	NIS	TCC	TCC	1,600	1,600	1,600	1,600	1,600	1,600	1,600	1,600	1,600	1,600
		175	10	NIS	NIS	NIS	TCC	TCC	1,400	1,400	1,400	1,400	1,400	1,400	1,400	1,400	1,400
		150	10	NIS	NIS	NIS	NIS	TCC	1,200	1,200	1,200	1,200	1,200	1,200	1,200	1,200	1,200
		125	10	NIS	NIS	NIS	NIS	NIS	TCC	TCC	1,000	1,000	1,000	1,000	1,000	1,000	1,000
		125	10	NIS	NIS	NIS	NIS	NIS	TCC	TCC	1,000	1,000	1,000	1,000	1,000	1,000	1,000
		110	12	NIS	NIS	NIS	NIS	NIS	NIS	TCC	TCC	1,003	1,003	1,003	1,003	1,003	1,003
		100	12	NIS	NIS	NIS	NIS	NIS	NIS	NIS	NIS	TCC	TCC	1,000	1,000	1,000	1,000
		90	12	NIS	NIS	NIS	NIS	NIS	NIS	NIS	NIS	TCC	TCC	864	864	864	864
		80	12	NIS	NIS	NIS	NIS	NIS	NIS	NIS	NIS	NIS	TCC	TCC	723	723	723
70	12	NIS	NIS	NIS	NIS	NIS	NIS	NIS	NIS	NIS	NIS	TCC	TCC	722	722		

NIS = not instantaneously selective. TCC = refer to time current curve.



Thermal Magnetic MCCB

Type	Amperes		Max. Inst. Pickup (X Plug)	Downstream: Lighting panel circuit breakers												
	Frame	Trip		THQB, TEY, FB												
				Trip	100-80A	70A	60A	50A	45A	40A	35A	30A	25A	20A	15A	
TF, THF	225	225	10		TCC	1,800	1,800	1,800	1,800	1,800	1,800	1,800	1,800	1,800	1,800	1,800
		200	10		NIS	TCC	1,600	1,600	1,600	1,600	1,600	1,600	1,600	1,600	1,600	1,600
		175	10		NIS	TCC	TCC	1,400	1,400	1,400	1,400	1,400	1,400	1,400	1,400	1,400
		150	10		NIS	NIS	TCC	1,200	1,200	1,200	1,200	1,200	1,200	1,200	1,200	1,200
		125	10		NIS	NIS	NIS	TCC	TCC	1,000	1,000	1,000	1,000	1,000	1,000	1,000
		125	10		NIS	NIS	NIS	TCC	TCC	1,000	1,000	1,000	1,000	1,000	1,000	1,000
		110	12		NIS	NIS	NIS	NIS	TCC	TCC	1,003	1,003	1,003	1,003	1,003	1,003
		100	12		NIS	NIS	NIS	NIS	NIS	TCC	TCC	1,000	1,000	1,000	1,000	1,000
		90	12		NIS	NIS	NIS	NIS	NIS	TCC	TCC	864	864	864	864	864
		80	12		NIS	NIS	NIS	NIS	NIS	NIS	TCC	TCC	723	723	723	723
	70	12		NIS	NIS	NIS	NIS	NIS	NIS	NIS	TCC	TCC	722	722	722	
TQD	225	225	-		NIS	2,025	2,025	2,025	2,025	2,025	2,025	2,025	2,025	2,025	2,025	2,025
		200	-		NIS	NIS	1,800	1,800	1,800	1,800	1,800	1,800	1,800	1,800	1,800	1,800
		175	-		NIS	NIS	NIS	1,575	1,575	1,575	1,575	1,575	1,575	1,575	1,575	1,575
		150	-		NIS	NIS	NIS	1,350	1,350	1,350	1,350	1,350	1,350	1,350	1,350	1,350
		125	-		NIS	NIS	NIS	NIS	NIS	1,125	1,125	1,125	1,125	1,125	1,125	1,125

NIS = not instantaneously selective. TCC = refer to time current curve



This information is based on data available at the time of printing (December 2010) and is believed to be accurate, but GE makes no warranty or guarantee regarding the accuracy of the information.

GE Energy
41 Woodford Avenue
Plainville, CT 06062

www.geindustrial.com



imagination at work