

Integritas* Industrial Battery Charger

Uncompromised Advanced Technology to Simplify Your Network

The Integritas is GE's highest reliability industrial battery charger designed for cabinet, wall-mounted or rack-mounted applications. It boasts true redundancy, a state of the art controller with monitoring capabilities, and supports NERC compliance. The Integritas series battery chargers can be configured for 24, 28, 48 or 125VDC output with capacities ranging from 20A to 300A. This provides scalability as well as significant higher power compared to traditional SCR based chargers. The charger is 17.5" (445mm) or 23" (564mm) wide and designed to mount directly to a wall or mounted into a standard battery frame. The system features an integrated, simple to operate, advanced monitoring and control system using field proven technology that offers market leading reliability and availability. Advanced maintenance and monitoring solutions provides minimal downtime and low mean time to repair.

Industry Applications

Systems are designed to minimize impact of pollutants by using conformal coating on all electronics and XXX filter to control airflow. IP41 design for indoor applications with an optional drip cover to prevent water from directly on the top of the charger. The chargers are intended for use in Power Utilities, Process Control, Transportation, and Oil & Gas Industries. Recommended, but not limited to application use for:

- Battery Charging / Standby Power
- Pump Control / Supply
- Emergency Lighting
- Switchgear Control Power

Compatible Charger Modules

Infinity Based Chargers:

- IP100AC024ATEZ
- IP085AC028ATEZ TBD
- IP050AC048ATEZ
- IP020AC125ATEZ

GP100 Based Chargers:

- IP100H3R024ATEZ TBD
- IP100H3R048ATEZ TBD
- IP100H3R125ATEZ (Available Q1 – 2018)

Pulsar Plus Controller Features and Advantages

The Pulsar Plus family of controllers provides system monitoring and control features for Infinity industrial battery charger systems. These controllers monitor and control system components including rectifiers, converters, and distribution modules via a multi-drop RS485 digital communications bus. System status, parameters, settings, and alarm thresholds can be viewed and configured from the controller's front panel display. Assignment and configuration of alarm inputs and output relays can be performed from a laptop computer connected to a local RS-232 or Ethernet port, or by remote access is through a network connection to the World Wide Web (internet) or your enterprise network (intranet).

This controller utilizes standard network management protocols allowing for advanced network supervision. Monitored data can be downloaded to almost any device securely. The controller can be optionally designed and configured to push the data to the customer network on a periodic basis. Advanced trend analysis and battery monitoring can also be incorporated into the controller via add on peripherals.

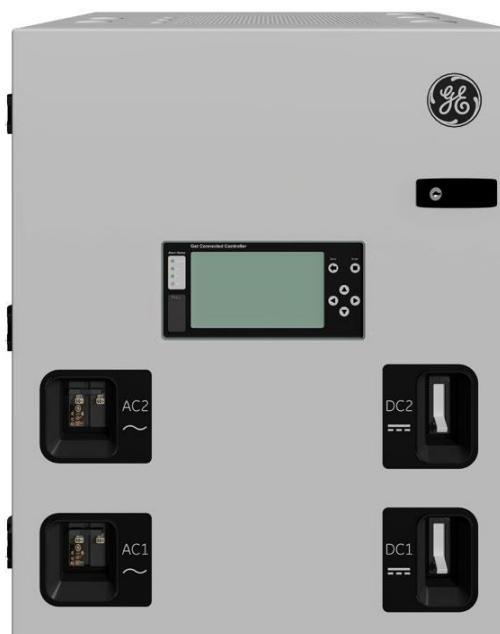

Integritas* Industrial Battery Charger

Table of Contents

- Important Safety Instructions 4
- Configuration and Product Features 5
 - Model Description..... 5
 - Charger Block Diagram 6
 - Ratings 7
 - Environmental, Safety and Industry Standards 10
- Charger Cabinet and Modules..... 11
 - Weights and Dimensions 11
 - Mounting 11
 - Mounting the Charger to a Wall 12
 - Mounting the Charger to a Rack..... 12
 - Input & Output Locations and Dimensions..... 12
 - Industrial Platform (IP) Power Conversion Modules..... 12
- AC Input..... 14
 - AC Input Selection..... 14
 - AC Input Cable and External Breaker Sizing 17
- DC Output 17
 - DC Output Selection 18
 - DC Output Signal Unit 19
 - Reverse Battery Polarity Detector 19
 - Voltage Test Points 19
 - Remote Shunt 19
 - Remote Voltage Sense..... 19
 - Remote Interlock..... 20
- Controls..... 21
 - Features 21
 - Integrated Monitoring Inputs and Outputs 21
- List of Spares..... 23
- Appendix A – Summary of Worldwide Power Information..... 24

Integritas* Industrial Battery Charger

- Table 1 Charger Cabinet Features 7
- Table 2 Cabinet Power Ratings 8
- Table 3 IP Rectifier Input Characteristics 8
- Table 4 IP Rectifier Output Characteristics 9
- Table 5 Environmental and Compliance 10
- Table 8 Rectifier and Converter Module Keying 13
- Table 10 Common Acceptable Electrical Distribution 15
- Table 11 Common Acceptable Electrical Distribution (page 2) 16
- Table 12 AC Input Breaker and Cable Sizing 17
- Table 13 AC Input Terminal Block Specifications 17

Integritas* Industrial Battery Charger

Important Safety Instructions

1. SAVE THESE INSTRUCTIONS – This document contains important safety and operating instructions for the Integritas battery charger.
2. Before using battery charger, read all instructions and cautionary markings on battery charger, battery, and all connected equipment.
3. Rules and Regulations - Follow all national and local rules and regulations when making field connections.
4. Field-wired Conductors - Follow all National Electric Code (NEC) and local rules and regulations.
 - a. Insulation rating: 90°C minimum; 105°C (minimum) if internal to enclosed equipment cabinets.
 - b. Size AC field-wired conductors with 75°C ampacity (NEC) equal to or greater than their panel board circuit breaker rating.
 - c. Size DC field-wired conductors with 90°C ampacity (NEC) equal to or greater than circuit breaker/fuse rating.
5. AC and DC input disconnect/protection - Provide accessible devices to remove input power in an emergency.
6. Compression Connectors
 - a. U. S. or Canada installations - use Listed/Certified compression connectors to terminate Listed/Certified field-wire conductors.
 - b. All installations - apply the appropriate connector to the correct size conductor as specified by the connector manufacturer, using only the connector manufacturer's recommended or approved tooling for that connector.
7. Electrical Connection Securing: Torque to the values specified on labels or in the product documentation.
8. Cable Dress - dress to avoid damage to the conductors and undue stress on the connectors.
9. Alarm Signals - Provide external current limiting protection. Rating—60V (125V for 125V charger), 0.5A unless otherwise noted.
10. Grounding - Connect the equipment chassis directly to ground.
11. WARNING: Equipment does not provide battery discharge control and protection. To be provided by external battery source.

Integritas* Industrial Battery Charger

Configuration and Product Features

The Integritas Wall Charger (IWC) uses the model configuration to define the features as well as how the charger is electrically and mechanically configured. Each character is used to designate how a feature is implemented in the charger. GE uses the base features required to meet most industry standards. In some instances, particularly in the controls section, some additional options may be necessary to meet specific industry requirements such as NERC and IEC81650.

We have tried to include all options possible to meet the current featured requirements in the major regions throughout the world. In cases where we do not meet the necessary requirements, please reach out to your sales associate for more information. Features and components in GREY are under design consideration but are not yet available at the time of publication of this document.

Model Description

CABINET TYPE

AC IN

DC OUT

CONTROLS

[3BR125] – [SHWY] – [S10Y] – [P000]

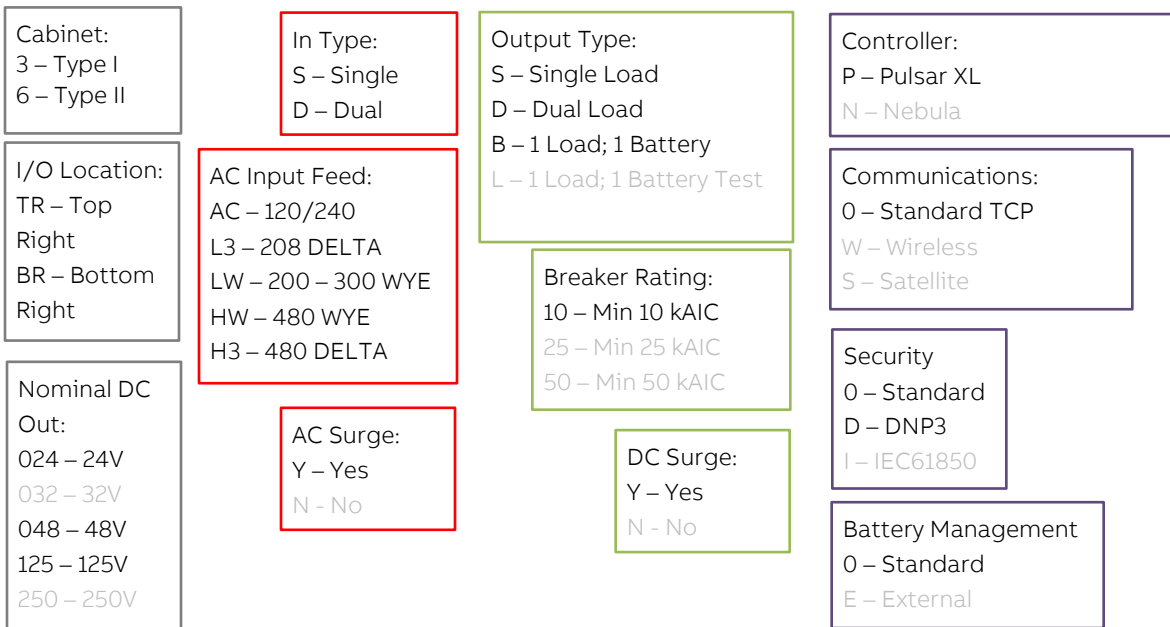

Integritas* Industrial Battery Charger

Charger Block Diagram

The IWC product family has basic building blocks between the two chassis and multiple configuration options.

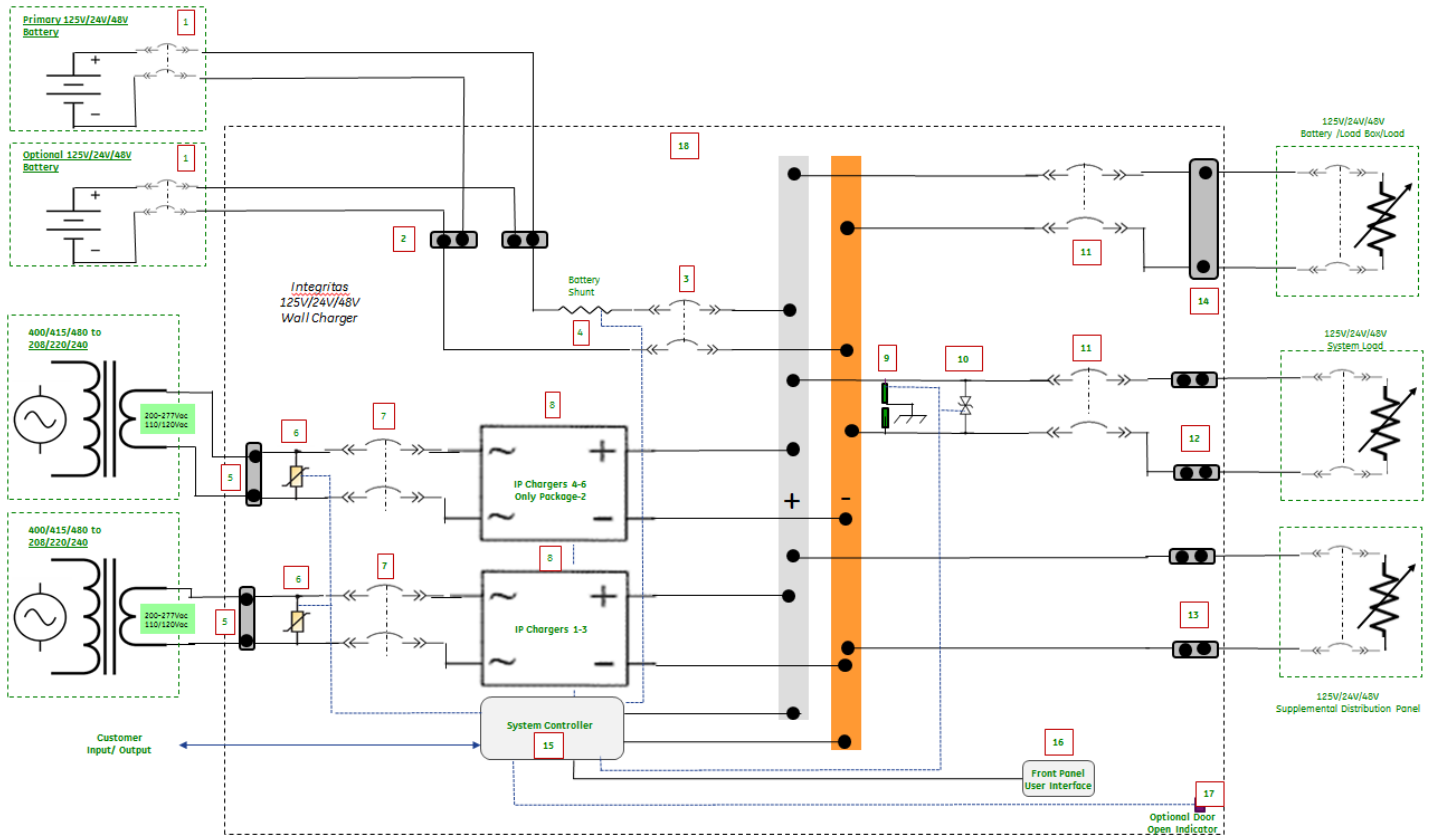

Figure 1 IWC General Schematic

The block diagram below provides a simple block diagram that illustrates these system components. Different configurations utilize different populations of these core components. The basic design of the 19" and 23" IWC chassis shall accommodate the configurability.

Item	Description
1	UL Listed battery disconnects located at the battery or outside of IWC. Batteries in the proximity of the IWC, relieves requirement for internal battery disconnect.
2	1-hole stud landings for connecting as many as two strings. ¹
3	Optional internal IWC battery disconnect breaker. When (1) is not in place, this disconnect is required and replaces the ability to have a second load breaker (11).
4	Internal shunt for battery current measurements. An option for an external shunt is desired.
5	AC input terminal block connections for ordered AC configuration. A second AC input terminal connection is available in the 23" IWC powering group of three IP modules for redundant powering option.

Integritas* Industrial Battery Charger

Item	Description
6	Compatible/Monitored AC input surge suppression for configured AC input.
7	Compatible AC input breaker for configured AC input.
8	IWC Industrial Power (IP) modules appropriate for configured system.
9	DC output Ground Fault detection and monitoring.
10	Optional monitored DC output surge suppression.
11	Primary output 2-pole DC load breaker. Optional breaker for multi-purpose use available when internal battery disconnects not present.
12	1-hole stud landings for output load connection. ¹
13	1-hole stud landings for optional supplemental load panel (TBD) residing in same frame/cabinet or directly under or above not requiring protector. ¹
14	1-hole stud landing or “designated connector” interface for optional supplemental bulk load or load box attachment, respectively, when internal battery disconnect is not utilized. Can also serve as temporary battery/power backup connect. ¹
15	Modular vertical mount system controller. One of two options: Pulsar IND or Next Gen.
16	System controller door-mounted front panel interface. One of two options: Pulsar Plus G3_IND or Next Gen.
17	Monitored door open/close device.
18	NEMA 2 enclosure with optional integrated air intake filter, door, and door (UL50 compliant) handle/lock mechanism.

Table 1 Charger Cabinet Features

Ratings

The IWC come in two different cabinet configurations: 19” and 23”. The 19” solution, also referred to as Type I, is capable of holding up to 3 – IP rectifier modules. The 23” solution, also referred to as Type II, is capable of holding up to 6 – IP rectifier modules.

Rectifier modules can operate at low nominal AC input of 120VAC up to 277VAC. Power output under low voltage conditions is limited to prevent overloading of the AC input circuits. As such each cabinet has a capacity rating for both low voltage and standard voltage input. Below is a representation of power regulation that is built in each rectifier module.

Integritas* Industrial Battery Charger

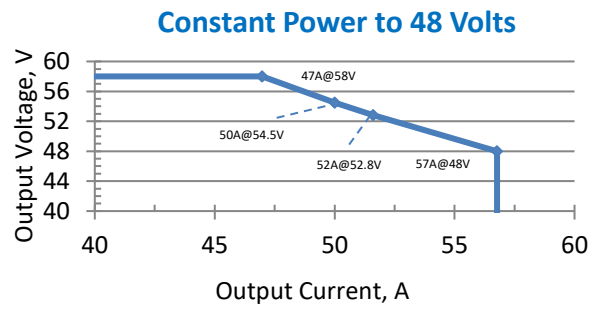
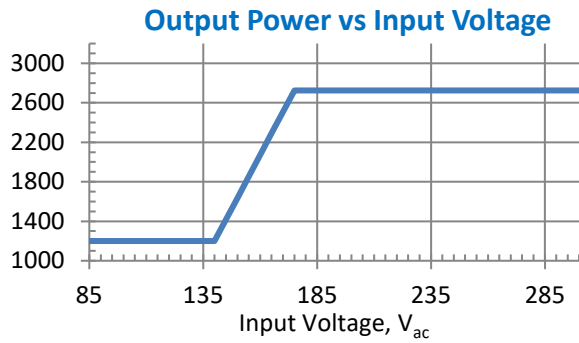

Cabinet power ratings are contained in the Table 2 below. Ratings are based on both input and output voltage.

Cabinet	AC Input	24V Nominal*		48V Nominal		125V Nominal	
19" Type I	Low Line	132A	3,600W	66A	3,600W	29A	3,600W
	High Line	150A	4,090W	150A	8,175W	60A	7,500W
23" Type II	Low Line	-	-	132A	7,200W	58A	7,200W
	High Line	-	-	150A	8,175W	120A	15,000W

Table 2 Cabinet Power Ratings

Tables 3 and 4 outline the operational characteristics of each IP rectifier offered in the IWC solution. As stated earlier GREYED out units are under design consideration for future releases.

AC Input Characteristics - Single Phase Charger Module									
Model	Input Range	120	200	208	220	240	277	Power Factor	Frequency Range
IP020AC125ATEZ	85 - 305	10.6	13.3	12.8	12.1	11.1	9.6	0.990	45 - 66
IP050AC048ATEZ	85 - 305	10.5	14.4	13.8	13.1	12.0	10.4	0.995	45 - 66
IP085AC028ATEZ	85 - 305	10.8	14.7	14.1	13.3	12.2	10.6	0.995	45 - 66
IP100AC024ATEZ	85 - 305	10.7	14.5	14.0	13.2	12.1	10.5	0.995	45 - 66
AC Input Characteristics - Three Phase Charger Module									
Model	Input Range			400	415	480		Power Factor	Frequency Range
IP040H3R125ATEZ	320 - 530	-	-	15.8	15.2	13.2	-	0.990	45 - 66
IP100H3R048ATEZ	320 - 530	-	-	15.8	15.2	13.2	-	0.995	45 - 66
IP100H3R024ATEZ	320 - 530	-	-	15.7	15.1	13.1	-	0.995	45 - 66

Table 3 IP Rectifier Input Characteristics

Integritas* Industrial Battery Charger







Charger		Output Current			Output Voltage			Thermal
Label	Model	Low Line	High Line	Setpoint (Factory)	Range (Vdc)	Regulation	Ripple (mVrms)	Max BTU/Hr
	IP020AC125ATEZ	8	20	125	90 - 160	+/- 0.5%	150	544
	IP050AC048ATEZ	22	50	54.5	42 - 58	+/- 0.5%	100	510
	IP085AC028ATEZ	44	85	30	21 - 32	+/- 0.5%	100	700
	IP100AC024ATEZ	44	100	27.25	21 - 29	+/- 0.5%	100	620
	IP040H3R125ATEZ	-	40	125	90 - 160	+/- 0.5%	150	1134
	IP100H3R048ATEZ	-	100	54.5	42 - 58	+/- 0.5%	100	1078
	IP100H3R024ATEZ	-	100	27.25	21 - 29	+/- 0.5%	100	482

Table 4 IP Rectifier Output Characteristics

Integritas* Industrial Battery Charger

Environmental, Safety and Industry Standards

The charger is designed to operate in extended environmental conditions. Each module, independent of its output voltage, can be operated between -40°C to +75°C. Modules PWBs are conformal coated with UV-40 conformal coat material to protect against most environmental contaminants and extreme conditions. The coating is MIL-I-46058C and IPC-CC-830 qualified and is recognized under the Component Program of Underwriters Laboratories, Inc., File Number E 105698. The UV-40 conformal coating adds the following properties to the electronic components in the IWC and PCMS:

- High Voltage Isolation to components (Dielectric Withstand Voltage >7,500)
- Protection from Metallic Dust
- Improved Humidity resistance
- Protection from airborne chemical exposure

The charger and its plug modules are designed and tested to the following Environmental, Safety and Industry Standards:

Environmental	
Operating Temperature	-40°C to +75°C (-40°F to 167°F) (de-rates after 50°C)
Storage Temperature	-40°C to +85°C (-40°F to 185°F)
Relative Humidity	95% max, non-condensing
Altitude	4000M (for altitudes above 2000M, peak operating temperature de-rates 0.656° C /100M; 4000M peak temperature rating is 62° C)
Safety and Standards Compliance	
NEMA	NEMA PE5 for modules, NEMA 2 Enclosure
Safety	UL 1012, ANSI/UL60950-1-2014 and CAN/CSA C22.2 No. 60950-1-07, Second Edition + A2:2014 (MOD), dated October 14, 2014
RoHS	Compliant to RoHS EU Directive 2002/95/EC RoHS 5/6
EMC	European Directive 2004/108/EC; EN55022, Class A; EN55024; FCC, Class A; GR1089-CORE, Issue 5
ESD	EN61000-4-2, Level 4
Protection	
Voltage	Input under voltage, Input over voltage, Output overvoltage, Output under-voltage
Current	Fuse in both the input lines, output over current protection, Output short circuit protection
Thermal	Over temperature protection and auto restart upon removal of over temperature condition
Surge	Input surge protection, Output surge protection
Reverse Polarity	Battery reverse polarity protection
Ground Fault	Ground fault detection and alarm (Only reporting)
Breakers	Industrial grade UL & IEC recognized bulk input and bulk output breaker

Table 5 Environmental and Compliance

Integritas* Industrial Battery Charger

Charger Cabinet and Modules

The IWC is designed into two main physical structures. One base structure is designed for mounting directly on a wall or **in** a 19" rack. The second base structure is designed for mounting directly on a wall or **on** a 23" rack. The 19" base wall charger structure hosts up to three Industrial Platform (IP) power conversion modules. The 23" rack-mount wall charger cabinet hosts up to six Industrial Platform (IP) power conversion modules. These IP charger modules are designed for bottom to top airflow and use a universal output connector to the charger cabinet traditional and integrations of the Infinity NE and GP100 standard power units that are presently installed in rack-mount shelves.

Weights and Dimensions

Weights and dimensions vary dependent on the overall configuration of the IWC. The below tables represent values based on the minimal configuration with simple input & output breakers with no rectifiers installed up to the largest configuration with max ac inputs & dc outputs with a full complement of rectifiers.

Cabinet	Height		Width		Depth		Door Swing	
	Inches	mm	Inches	mm	Inches	mm	Inches	mm
19" Type I	30.5	775	17.35	441	14.11	358	30.8	782
23 Type II	30.5	775	23	584	14.11	358	30.8	782

Cabinet		Min. Weight		Max Weight	
Size	Fill	Lbs.	KG	Lbs.	KG
19" Type I	Empty	60	27.2	68	30.9
	Loaded	96.3	43.7	104.3	47.4
23 Type II	Empty	71	32.2	87	39.5
	Loaded	143.6	65.2	159.6	72.5

Mounting

The IWC is designed to be mounted either on a wall or in a rack, in an area free of flammable/explosive materials. Hot air exits out of the top of the cabinet. We recommend not mounting temperature sensitive equipment above the cabinet.

Recommended Clearance:

- Above and Below the charger: 2 inches (5 cm)
- In Front of the charger: 36" (914 mm) to allow for maximum door swing

The IWC cabinet is optioned with either a Left or Right door as defined by standard ASME rules. Left (L) indicates the door handle is located on the left side of the door and the door opens Left to Right. Right (R) indicates the door handle is located on the right side of the door and the door opens right to left. Due to the routing of the display cable, this option can't be modified in the field. Ensure that you leave adequate space to the side of the charger to allow for the maximum door swing desired.

Integritas* Industrial Battery Charger

Mounting the Charger to a Wall

CAUTION Use safe lifting practices. The charger is heavy. Lifting devices are recommended. The wall and fasteners must safely support 470 lbs. (3 times the charger weight). Use the correct fasteners for the wall material and thickness being installed on.

Locate the appropriate location for mounting the charger ensuring that proper clearances and environmental impacts are taken into consideration. Do not mount on heat generating surfaces or exposed to external environment without providing adequate protection from heat and moisture.

Mount the cabinet with 8 sets of mounting hardware rated for at least 60 lbs. each. For ease of installation, it is recommended to attach the lower bracket to the wall first. The installer can use the bottom bracket to support the unit while attaching the second, upper bracket for securing the cabinet to the wall. Torque mounting hardware in accordance with the fastener manufacturing recommendations

Mounting the Charger to a Rack

Optional rack mount hardware is available for purchase for mounting the battery chargers into or onto relay racks. To ensure proper support is important to select the appropriate kit for the rack you are installing the charger into (19" or 23"). Brackets can be flipped to modify rack mounting depth as necessary.

Orient optional rack mount brackets for the proper mounting to the charger cabinet. Each bracket uses 8 screws to attach to the charger cabinet. Torque each screw to 25 in-lb (2.8 Nm).

Attach the entire system to the rack using a minimum of twelve (six on each side) 12-24 screws (provided). Using a 5/16" socket, torque each screw to 35 in-lb (4.0 Nm).

Input & Output Locations and Dimensions

Input and output locations are pre-configured in the base model prior to purchase. AC and DC I/O's can be optioned to enter and exit out of the top of the IWC or the bottom. Controller I/O's can be sent out of the top or the bottom of any IWC no matter the configuration.

AC input for the IWC is always located on the left side of the cabinet, whereas the DC output is always located on the right. Whether the input & output locations are on the top or bottom of the cabinet conduit knockouts are provided with the following sizes:

Type	Quantity	Size	
AC	2	1-1/2"	Internal diameter for conduit
DC	3	2"	Internal diameter for conduit
Alarm	6	1/2"	3 on top and 3 on bottom. Internal diameter for conduit

Industrial Platform (IP) Power Conversion Modules

Power Conversion Modules (PCM) are designed to be inserted in a vertical orientation. This provides for a shallow depth for the charger. Each PCM uses a minimum of 2 – 38mm to provide bottom to top airflow through the module for cooling purposes. These fans are variable speed and only run as needed to keep component temperatures on the modules in their standard operating temperatures.

PCMs use a common chassis to allow for flexibility in the construction of the cabinet enclosure and IWC backplane. IWCs and PCMs are keyed for voltage input and voltage output. This prevents the inadvertent injection of an incompatible module into the incorrect IWC. There are two keys located on each PCM, one at the top of the module and one at the bottom of the module. The top key indicates the voltage input type whereas

Integritas* Industrial Battery Charger

the bottom key identifies the output voltage. Table 8 below shows the key indicators for each PCM planned for use in the IWC.

IP Module	Type	Input (Top Key)				Output (Bottom Key)			
		AC Single Phase	AC 3-Phase (480V)	125VDC	250VDC	24V	48V	125V	250V
		Pos 1	Pos 2	Pos 3	Pos 4	Pos 1	Pos 2	Pos 3	Pos 4
IP020ACR125ATEZ	Rectifier	X						X	
IP050ACR048ATEZ	Rectifier	X					X		
IP100ACR024ATEZ	Rectifier	X				X			
IP020H3R250ATEZ	Rectifier		X						X
IP020H3R125ATEZ	Rectifier		X					X	
IP020H3R048ATEZ	Rectifier		X				X		
IP020H3R024ATEZ	Rectifier		X			X			
IP075DC125C024ATEZ	Converter			X		X			
IP040DC125C048ATEZ	Converter			X			X		
IP075DC250C024ATEZ	Converter				X	X			
IP040D250C048ATEZ	Converter				X		X		

Table 6 Rectifier and Converter Module Keying

PCMs are hot-swappable and can be replaced without the need of tools. Each module has two collapsible handles on the front of each module to support insertion and removal of from the charger cabinet. There are two thumb screws, one on top and one on bottom, used to retain the rectifier in place during operation. The thumb screws should be hand tightened; however, they do have a center Phillips #2 screw to torque beyond hand tight. Screws should not be over tightened beyond 10 in-lbs.

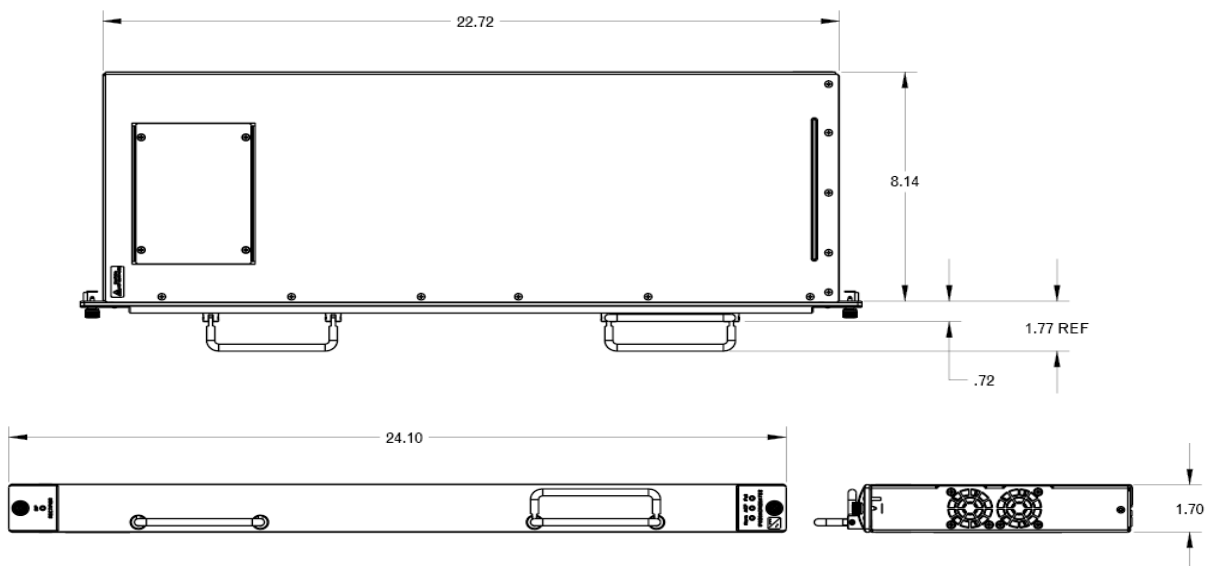

Integritas* Industrial Battery Charger

AC Input

AC input may be varied to meet regional AC power availability. In all cases GE recommends following local wiring and protection schemes. All systems ship with an input disconnect switch that is rated for the maximum capacity of the charger.

Type I cabinets have a single AC disconnect whereas Type II cabinets have an additional option of dual AC inputs. Dual AC inputs allow the user to effectively create an N+N charger in the same cabinet.

Each AC input is accompanied with a matched Surge protective device. The protective device is rated for the capacity, voltage and AC frequency of the system. MOV's are of the pluggable type to allow for field replacement in the event of excessive firing. Replacement MOV modules are available to purchase through your sales person. Module part numbers can be found in "List of Spares" table later in this document.

AC Input Selection

AC inputs are broken down into five different options. These options define three parts of the AC input section of the IWC: Breaker/disconnect, Surge Protector, and customer terminal block.

Below is a representation of the various configurable input AC codes and its associated AC input range.

Code	AC Range	Electrical Schematic
AC	120 / 240	6, 12
L3	208 Delta	10
LW	200 - 300 WYE	1, 7, 9
HW	400- 480 Wye	1, 9
H3	380 - 480 Delta	10

Basic electrical schematics for each of these codes follow on the next two pages in the "Common Acceptable Electrical Distribution". This table can be used to identify the AC infrastructure available at the installation site. Input distribution types highlighted in blue indicate electric distributions that are supported by the IWC. All other versions are considered non-supported under our current engineering designs.

An additional table in Appendix B at the end of this document to help identify local power sources that are available in most regions around the globe. The Table provides the following information:

- Country
- Frequency (Hz) and Tolerance (%)
- Residential Voltages
- Commercial Voltages
- Industrial Voltages
- Voltage Tolerance (%)

Common Acceptable Electrical Distribution	
<p>1. 3-Phase Wye: 4-Wire; Grounded Neutral and Contiguous Ground</p> 	<p>4. 3-Phase Open Delta: 4-Wire; Grounded at Midpoint of Phase; Contiguous Ground</p> 
<p>2. 2-Phase Wye: 3-Wire; Grounded Neutral and Contiguous Ground (typically called a single-phase supply in North America)</p> 	<p>5. Single-Phase: 3-Wire; Grounded Neutral; Grounded at Midpoint of Phase; Contiguous Ground</p> 
<p>3. 3-Phase Delta: 4-Wire; Grounded at Midpoint of Phase; Contiguous Ground</p> 	<p>6. Single-Phase: 2-Wire; Grounded Neutral and Contiguous Ground</p> 

Table 7 Common Acceptable Electrical Distribution

Common Acceptable Electrical Distribution	
<p>7. 3-Phase Wye: 3-Wire</p> 	<p>10. 3-Phase Delta: 3-Wire</p> 
<p>8. 3-Phase Wye: 3-Wire; Grounded Neutral Point</p> 	<p>11. 3-Phase Open Delta: 3-Wire; Grounded Junction of Phases</p> 
<p>9. 3-Phase Wye: 4-Wire; Non-grounded Neutral</p> 	<p>12. Single-Phase: 2-Wire; Non-grounded Neutral</p> 

Table 8 Common Acceptable Electrical Distribution (page 2)

Integritas* Industrial Battery Charger

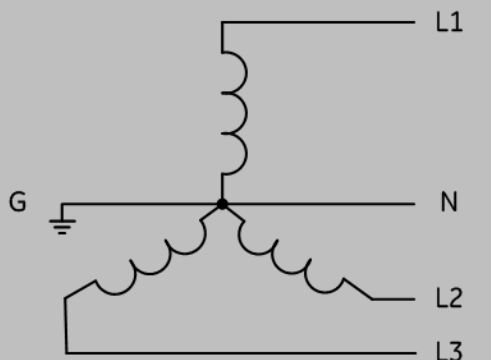
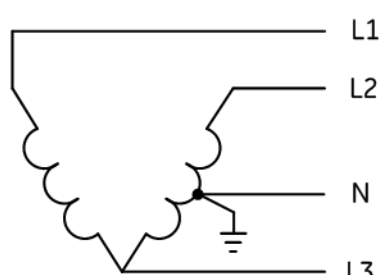
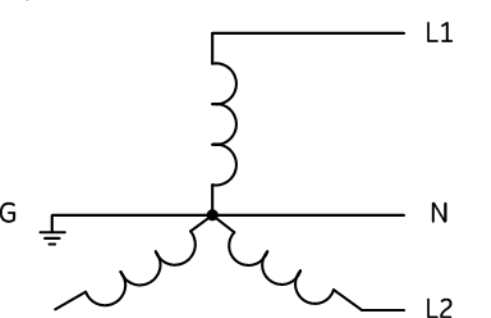
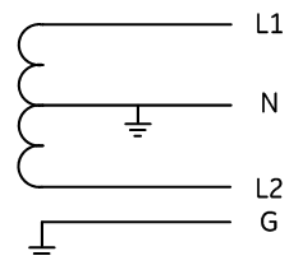
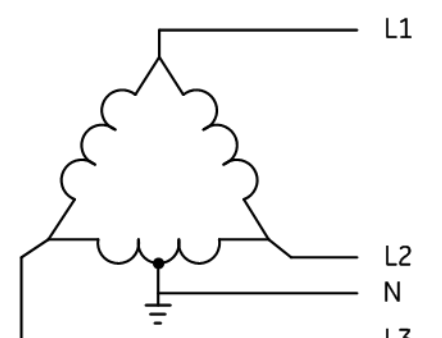
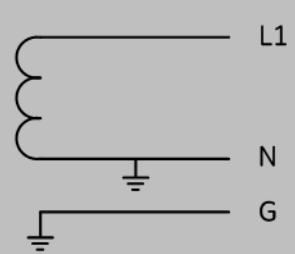
AC Input Cable and External Breaker Sizing

AC input will vary based on the AC input selection. In each case, the Customer AC Input Connection will utilize the same size terminal block. All AC connections should follow National Electric Code (NEC) and local rules and regulations. Size AC field-wired conductors with 75°C ampacity equal to or greater than their panel board circuit breaker rating.

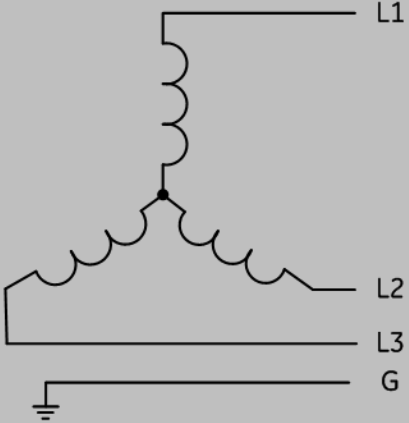
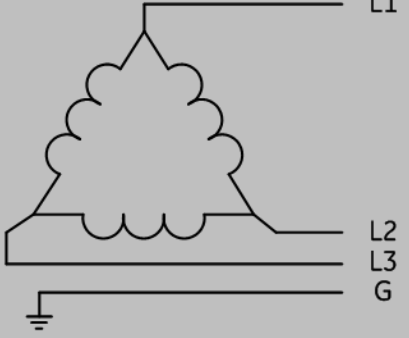
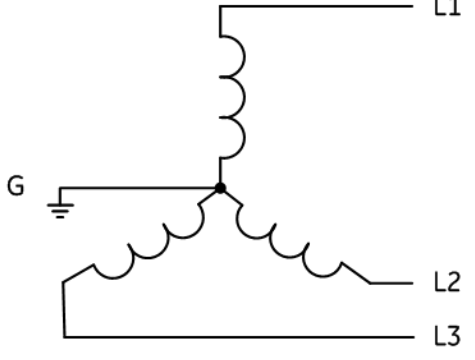
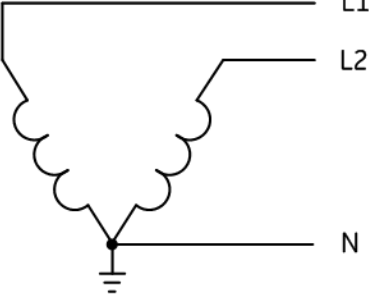
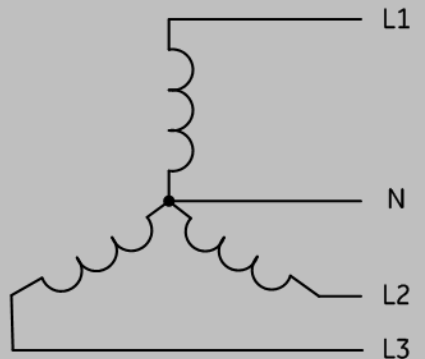
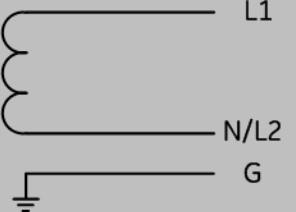
			120V~ Phase to Neutral (1200W per rectifier max)	240V~ Phase to Phase (2725W per rectifier max)		
Single-Phase Rectifiers						
Cabinet Type	Rectifier Positions Powered	Maximum Rectifiers per Feed	External Feed Protector	Minimum Wire	External Feed Protector	Minimum Wire
I - 19" or II - 23" Dual AC	1	1	20A	14AWG	20A	14AWG
	2	2	40A	8AWG	40A	8AWG
	3 Rectifier Charger—All positions	3	60A	6AWG	60A	6AWG
II - 23" Single AC	4	4	80A	4AWG	80A	4AWG
	5	5	100A	2AWG	100A	2AWG
	6 (All Positions Powered)	6	120A	1AWG	120A	1AWG

Table 9 AC Input Breaker and Cable Sizing

Input terminal blocks are sized for the appropriate amount of input current to meet a minimum operating ambient temperature of 50°C under maximum loading conditions. To maintain proper operating temperature of each connection, the installer should use the following Torque table for securing connections.

Maximum Rectifiers per Feed	Conductor Cross Section				Torque			
	US Standard (AWG)		Metric (mm ²)		US Standard (in-lbs)		Metric (Nm)	
	Min	Max	Min	Max	Min	Max	Min	Max
3	20	6	0.5	16	13.3	15.9	1.5	1.8
6	6	2/0	16	70	53	70	6	8

Table 10 AC Input Terminal Block Specifications

DC Output

In all cases GE recommends following local wiring and protection schemes. All systems ship with an output disconnect switch or switches that are rated for the maximum capacity of the charger.

Integritas* Industrial Battery Charger

The DC output is accompanied with a matching Surge protective device. The protective device is rated for the capacity and operating voltage range of the system. MOV's are of the pluggable type to allow for field replacement in the event of excessive firing. Replacement MOV modules are available to purchase through your sales person. Module part numbers can be found in "List of Spares" table later in this document.

The DC output section is equipped with a ground fault detection circuit. The detection circuit is designed to monitor the insulation resistance and system leakage capacitance between each polarity and system earth. If at any time the resistance falls below the user assign threshold (1 – 100 kΩ) an alarm indicator on the detector is lit and an alarm is sent to the system controller.

DC Output Selection

The IWC has 4 options for DC outputs. These options define how the load and battery connections are made in the charger. The standard output breakers in the IWC are 2-pole and rated at a minimum of 10kaic. Additional higher ratings are available at 25kaic and 50kaic. The below schematic shows the

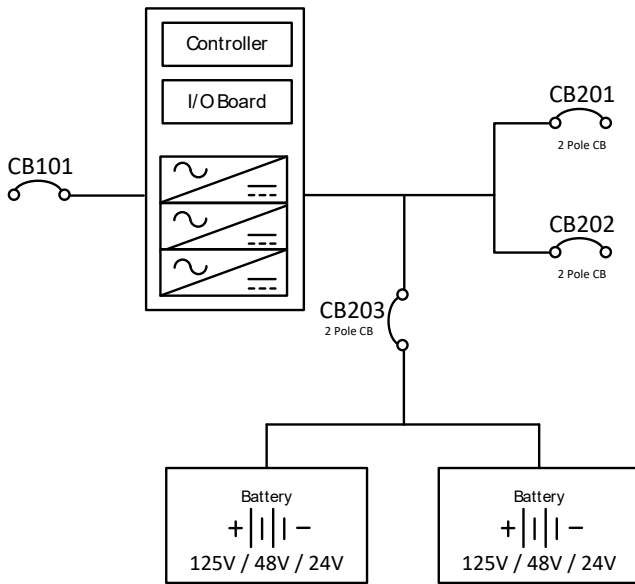

Figure 3 DC Output Schematic

Type	Feature	CB201	CB202	CB203
S	Single Bulk Output Breaker	x		
D	Dual Bulk Output Breakers	x	x	
B	One Bulk Load Breaker and One Battery Breaker	x		x
L	One Bulk Load Breaker; One Battery Breaker and One Load Test Connection	x		x

Integritas* Industrial Battery Charger

Output terminal blocks are sized for the appropriate amount of output current to meet a minimum operating ambient temperature of 50°C under maximum loading conditions. To maintain proper operating temperature of each connection, the installer should use the following Torque table for securing connections.

Conductor Cross Section				Torque			
US Standard (AWG)		Metric (mm ²)		US Standard (in-lbs)		Metric (Nm)	
Min	Max	Min	Max	Min	Max	Min	Max
20	6	0.5	16	13.3	15.9	1.5	1.8
6	2/0	16	70	53	70	6	8

DC Output Signal Unit

Each charger comes equipped with an output signal unit which is installed in the DC output box. This unit incorporates a reverse battery polarity detection circuit, output voltage test points, remote shunt, remote voltage sense, and a remote interlock function.

Reverse Battery Polarity Detector

The reverse battery polarity detection circuit is used to identify the polarity of the battery at the time of installation. A green light indicates proper polarity whereas a red light indicates the batteries are connected backwards. The installer should connect batteries to the system and evaluate this lamp prior to turning on any output breakers. If the indicator is red, then the battery leads are reversed and will need to be remedied prior to charger start up.

Voltage Test Points

The test points provided on this card measure the DC output voltage on the output side of the charger. The test point uses a 1:100 voltage reduction measurement. A measurement of 1.25VDC on the test point would be equivalent to 125VDC on the charger output.

Remote Shunt

A remote shunt monitoring circuit is available for monitoring a shunt at a remote battery connection panel. The IWC may only monitor one shunt at a time. To enable this feature, the jumpers on headers on the rear of the IWC center panel by removing the rear panel and moving jumpers on HDR11 and HDR12 to remote. More details on how to perform this function can be found in the Quick Start Guide (8600092587P).

Remote Voltage Sense

Remote voltage sense operates similarly to the remote shunt monitoring as it gives the user the capability for remotely reading bus voltage on an external distribution or battery. This is useful especially when the distribution or battery is in a remote room and you wish to compensate for potential voltage losses in the external cabling. The charger output voltage will be adjusted such that the remote voltage is optimal. Additional current limiting modules are necessary to prevent damage to the system controller.

Battery	Module
125V	847540424
24/48V	848738278

Integritas* Industrial Battery Charger

Remote Interlock

Remote interlock is used to provide a remote shutdown of the chargers. The IWC ships with this feature disabled by a jumper installed in the factory. To enable this function, remove the jumper and extend a pair of wires to the disconnect device. A normally closed contact is required for standard functionality. Opening the contact will turn off the rectifiers in the charger. To reenable rectifier operation, a closed contact must be reapplied to the interlock.

Integritas* Industrial Battery Charger

Controls

The Pulsar Plus family of controllers provides system monitoring and control features for Infinity industrial battery charger systems. These controllers monitor and control system components including rectifiers, converters, and distribution modules via a multi-drop RS485 digital communications bus. System status, parameters, settings, and alarm thresholds can be viewed and configured from the controller's front panel display. Assignment and configuration of alarm inputs and output relays can be performed from a laptop computer connected to a local RS-232 or Ethernet port, or by remote access through a network connection to the World Wide Web (internet) or your enterprise network (intranet).

Features

Remote Access and Features

- Integrated 10/100Base-T

Ethernet Network

- TCP/IP, SSH, SSL
 - SNMP V2c, SNMPV3, IPV6
 - SMTP for email
 - Telnet for command line interface
 - DHCP for plug-n-play
 - FTP for rapid backup and upgrades
 - HTTP & HTTPS for standard web pages and web browsers.
 - Shielded RJ-45 interface referenced to chassis ground
- Password protected security levels: User, Super-User, Administrator for all access
 - Ground-referenced RS232 system port
 - ANSI T1.317 command-line interface
 - EasyView2, Windows-based GUI software for local terminal access

Standard System Features

- Monitor and control of more than 40 connected devices
- Standard and user defined alarms
 - Alarm test
 - Assignable alarm severity: Critical, Major, Minor, Warning, and record-only

- 10 alarm relays (7 user assigned)

Rectifier management features

- Automatic rectifier restart
- Active Rectifier Management
- ARM (energy efficiency)
- Remote rectifier (on/off)
- Reserve Operation
- Automatic rectifier sequence control
- N + X redundancy check

- Multiple Low Voltage Load and Low Voltage Battery Disconnect thresholds

- Configuration, statistics, and history

- All stored in non-volatile memory
 - Remote/local backup and restore of configuration data
- Industry standard defaults
 - Customer specific configurations Available
 - Remote/ local software upgrade

- Basic, busy hour, and trend statistics
- Detailed event history
- User defined events and derived channels

Standard Battery Management Features

- Float/boost mode control
 - Manual boost
 - Manual timed boost locally, T1.317, and remotely initiated
 - Auto boost terminated by time or current
- Battery discharge testing
 - Manual (local/remote)
 - Periodic
 - Plant Battery Test (PBT) input driven
 - Configurable threshold or 20% algorithm
 - Graphical discharge data
 - Rectifiers on-line during test
- Slope thermal compensation
 - High temperature
 - Low temperature
 - Step temperature
 - STC Enable/Disable, low temperature Enable/Disable
 - Configurable mV/°C slopes
- State of charge indication
- High temperature disconnect setting
- Reserve-time prediction
- Recharge current limit
- Emergency Power-Off input

Integrated Monitoring Inputs and Outputs

System plant voltage and current monitoring: Accuracy $\pm 0.5\%$ Resolution 0.1V

Battery Shunt mounted on the Negative bus: Accuracy $\pm 0.5\%$ full scale Resolution 1A

Up to 15 Binary inputs; 6 close/open to positive, 9 close/open to negative all user assignable

Up to 10 Form-C output alarms (125Vdc @ 0.5A)

1-Wire* bus devices for up to 16 temperature probes (battery and ambient)

Integritas* Industrial Battery Charger

Alarm Outputs		
Connector	Description—Signal on Pin 1	Pin 2
TB1	Power Critical Alarm	Common
TB2	Power Major Alarm	Common
TB3	Power Minor Alarm	Common
TB4	Alarm R1 (default is RFA/MRFA)	Common
TB5	Alarm R2 (default is ACFMACF)	Common
TB6	Alarm R3 (default is BD/VLV)	Common
TB7	Alarm R4 (default is GFI)	Common
TB8	Alarm R5 (default is SPD, DC, and AC)	Common
TB9	Alarm R6 (default is BTA “Battery Test Active”)	Common
TB10	Alarm R7 (default is “Check Battery”)	Common
Alarm Inputs		
Connector	Description—Signal on Pin 1	Pin 2
TB11 (IN007)	“Dry” No Voltage Binary contact input (default is AUX1 “Air Conditioner Fail”)	No Voltage Return
TB12 (IN008)	“Dry” No Voltage Binary contact input (default is AUX2 “Door Open”)	No Voltage Return
TB13 (IN009)	“Dry” No Voltage Binary contact input (default AUX3 “High External Ambient”)	No Voltage Return
TB14 (IN010)	“Dry” No Voltage Binary contact input (default AUX4 “Low External Ambient”)	No Voltage Return
TB15 (IN006)	“Dry” No Voltage Binary contact input (default “Plant Battery Test (PBT)”)	No Voltage Return
TB16 (IN005)	“Dry” No Voltage Binary contact input (default “Remote Rectifier Standby/Emergency Power Off”)	No Voltage Return
TB17 (IN001)	“Dry” 24V Biased Binary contact input 24V Source (default “AUX9 Auxiliary 9”)	24V Source
TB18 (IN002)	“Dry” 24V Biased Binary contact input (default AUX8, “Auxiliary 8”)	24V Source
TB19 (IN004)	“Dry” 24V Biased Binary contact input 24V Source (default OSA1, “Open String”)	24V Source
TB20 (IN003)	“Dry” 24V Biased Binary contact input (default AUX6, “Hydrogen Present”)	24V Source
TB21	+24V Alternative external 24VDC back bias input for controller.	+24V DC Return
System Communication Ports		
Connector	Description—Signal on Pin 1	Pin 2
RECT DATA	Connection to isolated rectifier RS485 Galaxy protocol serial bus.	not applicable
1-WIRE DATA	Connection to 1-Wire temperature probes. 1-Wire signal on pin 1.	1-Wire Return

Each alarm I/O has a removable connector to make field wiring easier. The terminals can utilize wire sizes from 28 AWG/kcmil to 16 AWG/kcmil. Torque connections to a minimum of 0.22 Nm (1.95 in-lbs.) to a maximum of 0.25 Nm (2.21 in-lbs.). An alarm I/O label is provided on the inside of the door for site specific alarming and/or notations. A sample of the alarm I/O label can be found in Appendix C of this document.

Integritas* Industrial Battery Charger

List of Spares

The below is a list of pluggable modules for the Integritas Wall Charger. Recommended spares are application specific and are provided for in this list.

Power Modules		
Comcode	Description	Application
150050531	IP020ACR125ATEZ	125VDC Hot-Swappable Integritas Charger Module, Single Phase 120 - 277AC Input, 20A Output
150050530	IP050ACR048ATEZ	48VDC Hot-Swappable Integritas Charger Module, Single Phase 120 - 277AC Input, 50A Output
150052733	IP100ACR024ATEZ	24VDC Hot-Swappable Integritas Charger Module, Single Phase 120 - 277AC Input, 100A Output
8600092348P	Blank IP Charger Faceplate	Blank filler for empty charger slots

Controller Modules		
Comcode	Description	Application
1600093508A	IP843G_24V_S CONTROLLER MODULE	Integritas Wall Charger, Hot- Swappable 24VDC Controller Module with secure protocols
1600093510A	IP843G_48V_S CONTROLLER MODULE	Integritas Wall Charger, Hot- Swappable 48VDC Controller Module with secure protocols
1600093509A	IP843G_125V_S CONTROLLER MODULE	Integritas Wall Charger, Hot- Swappable 125VDC Controller Module with secure protocols
1600093511A	IP843G_IO MODULE	Integritas Wall Charger, Input / Output Module (Compatible with all charger voltages)

Thermal Probes		
Comcode	Description	Application
1600093512A	DTP873_AMBIENT	Ambient Thermal Probe Kit
1600093513A	DTP873_BATTERY	Battery Terminal Thermal Probe Kit

Additional Accessories (Mounting Hardware, Filters, etc.)		
Comcode	Description	Application
1600097831A	19" FRAME MOUNT KIT	Mounting hardware to attach 19" Charger to 19" Frame
1600097832A	19" TO 23" FRAME MOUNT KIT	Mounting hardware to attach 19" Charger to 23" Frame
850052732	FILTER, WALL BOX, 19"	Air Filter for 19" Battery Charger cabinet
850053032	FILTER, WALL BOX, 23"	Air Filter for 23" Battery Charger cabinet
4600097827P	VAL-CP-350-ST 2859602	AC Line Surge Arrestor Replacement Module
4600097268P	VAL-CP-N/PE-350-ST 2859699	AC N-PE Surge Arrestor Replacement Module
4600097830P	PST-SEC-T3-24P 2905232	24V DC Surge Arrestor Replacement Module
4600097829P	PST-SEC-T3-60P 2905233	48V DC Surge Arrestor Replacement Module
4600097828P	PST-SEC-T3-230P 2905235	125V DC Surge Arrestor Replacement Module

Floor Charger Controller Modules		
Comcode	Description	Application
150050081	NE843G3_IND24V_S CONTROLLER	Integritas Floor Charger, 24VDC Controller Module with secure protocols and I/O Ports
150050082	NE843G3_IND125V_S CONTROLLER	Integritas Floor Charger, 125VDC Controller Module with secure protocols and I/O Ports

Integritas* Industrial Battery Charger

Appendix A – Summary of Worldwide Power Information

Table A-1 lists ac power information for residential, commercial, and industrial facilities throughout the world, in alphabetic order by country. In the table, numbers in parentheses identify the electrical-distribution system in Figure A-1 or Figure A-2 that is used. Lowercase letters in parentheses identify one of the following notes:

- a. The supply to each residence is normally single-phase, using one phase line and neutral from electrical-distribution systems shown in Diagrams 1 and 3 from Figure A-1.
- b. Frequencies below 50 Hz and dc supplies are only in limited areas. The supplies given indicate the range of possibilities that might exist.
- c. Information on higher voltage supplies to factories is not available.
- d. More than one area of the country has been listed to illustrate the differences that exist. These might not be the only supplies available in that country.
- e. Frequency is 50 Hz in eastern Japan and 60 Hz in western Japan. The dividing line is a north/south line through Shizuoka on Honshu Island.
- f. Some remote areas are supplied from a single-wire earthed return (SWER) system.
- g. Only a few towns have this supply.
- h. Refers to isolated mining districts.
- i. This information is not available at this time.
- j. The neutral wire of the secondary distribution system is grounded.

Table A-1: Summary of Worldwide Power Information

Country	Frequency (Hz) and Tolerance (%)	Residential Voltage	Commercial Voltage	Industrial Voltage	Voltage Tolerance (%)
Afghanistan, D. R. of	50	380/220 (1) 220 (6)	380/220 (1)	380/220 (1, c)	(i)
Albania	50	220 (6, a)	380/220 (1)	380/220 (1)	(i)
Algeria	50 ±1.5	220/127 (2) 220 (6, a)	380/220 (1) 220/127 (1) 380/220 (1)	10 kV 6.6 kV 5.5 kV	±5 and ±10
Angola (j)	50	220 (6, a)	380/220 (1)	380/220 (1)	(i)
Anguilla	50	230 (6, a)	400/230 (1)	400/230 (1, c)	(i)
Antigua	60	230 (6, a)	400/230 (1)	400/230 (1, c)	(i)
Argentina	50 ±1.0	225 (6, a) 220 (6, a)	390/225 (1) 380/220 (1) 220 (6) 380/220 (1)	13.2 kV 6.88 kV 390/225 (1)	±10

Integritas* Industrial Battery Charger

Table A-1: Summary of Worldwide Power Information					
Country	Frequency (Hz) and Tolerance (%)	Residential Voltage	Commercial Voltage	Industrial Voltage	Voltage Tolerance (%)
Australia (j) (Excluding Western)	50 ±0.1	415/240 (1, 2) 240 (6)	415/240 (1) 440/250 (1) 440 (f) 415/240 (1) 440/250 (1)	22 kV 11 kV 6.6 kV	±6
Western Austria	50 50 ±0.1	440/250 (1) 380/220 (1, 7) 220 (6)	(i) 380/220 (1, 7) 220 (6) 5 kV 380/220 (1)	(i) 20 kV 10 kV	±6 ±5
Azores (Portugal)	50	220 (6) 120 (6)	380/220 (1)	380/220 (1)	
Bahamas	60	240/120 (3) 120 (6)	240/120 (3) 120 (6)	415/240 (1, c) 208/120 (1)	(i)
Bahrain Fir	50 & 60	400/230 (1) 230 (6) 110 (6)	400/230 (1) 380/220 (1) 230 (6) 220/110 (5)	11 kV 400/230 (1) 380/220 (1)	±6
Bangladesh	50 ±4	400/230 (1) 230 (6)	11 kV 400/230 (1)	11 kV 400/230 (1)	±5
Barbados	50 ±0.4	230/115 (3, 5) 200/115 (1, 2)	230/115 (3, 5) 200/115 (1, 2)	11 kV 3.3 kV 230/115 (3) 200/115 (1)	±6
Belgium	50 ±3	380/220 (1) 220/127 (1) 220 (10)	380/220 (1) 220/127 (1) 220 (10) 220/127 (1) 220 (10)	15 kV 6 kV 380/220 (1)	±5 (day) ±10 (night)
Belize	60 ±0.1	220/110 (5)	220/110 (5)	440/220 (5, c)	(i)
Benin	50 ±1	380/220 (1) 220 (6)	380/220 (1) 220 (6)	5 kV 380/220 (1)	±10
Bermuda	60 ±0.1	240/120 (5) 208/120 (1)	240/120 (5) 208/120 (1)	4.16/2.4 kV 208/120 (1) 240/120 (5)	±5
Bolivia	50 ±1	230/115 (4)	230/115 (4)	230/115 (4, c)	±5

Integritas* Industrial Battery Charger

Table A-1: Summary of Worldwide Power Information					
Country	Frequency (Hz) and Tolerance (%)	Residential Voltage	Commercial Voltage	Industrial Voltage	Voltage Tolerance (%)
Bosnia & Herzegovina	50	380/220 (1)	380/220 (1)	10 kV	(i)
		220 (6)	220 (6)	6.6 kV 380/220 (1)	
Botswana	50	220 (6, a)	380/220 (1)	380/220 (1, c)	(i)
Brazil (j)	60	220 (6, a)	380/220 (1)	13.8 kV	(i)
		127 (6, a)	220/127 (1)	11.2 kV 380/220 (1) 220/127 (1)	
Brunei	50	240 (6)	415/240 (1)	22 kV	±5
				415/240 (1)	
Bulgaria	50 ±0.1	380/220 (1) 220 (6)	380/220 (1) 220 (6)	20 kV	±5
				15 kV 380/220 (1)	
Burma	50	230 (6, a)	400/230 (1) 230 (6)	11 kV	(i)
				6.6 kV 400/230 (1)	
Burundi	50	220 (6)	380/220 (1)	380/220 (1)	
Cambodia	50	208/120 (1)	380/220 (1)	380/220 (1, c)	(i)
		120 (6)	208/120 (1)	208/120 (1)	
Cameroon (FR)	50 ±2	220 (6, a)	380/220 (1)	15 kV	±5
				380/220 (1)	
Canada	60 ±0.02	240/120 (5)	600/347 (1)	12.5/7.2 kV	±4
			480 (10)	600/347 (1)	
			240 (10)	208/120 (1)	
			240/120 (5)	600 (10)	
			208/120 (1)	480 (10)	
Cayman Islands	60 ±0.1	240/120 (5)	240/120 (5, 3)	480/240 (3)	±10
				480/227 (1)	
				240/120 (3)	
				208/120 (1)	
Central Africa	50	220 (6, a)	220 (6, a)	380/220 (1, c)	(i)
Chad	50	220 (6, a)	220 (6, a)	380/220 (1, c)	(i)
Chile	50	220 (6, a)	380/220 (1, a)	380/220 (1, c)	(i)
China, P. R. of	50	220 (6, a)	80/220 (1)	380/220 (1, c)	±7
Colombia	60 ±1	240/120 (5)	240/120 (3)	13.2 kV	±10
		120 (6)	120 (6)	240/120 (3)	

Integritas* Industrial Battery Charger

Table A-1: Summary of Worldwide Power Information

Country	Frequency (Hz) and Tolerance (%)	Residential Voltage	Commercial Voltage	Industrial Voltage	Voltage Tolerance (%)
Commonwealth of Independent States (and other former Soviet Rep)	50	380/220 (1) 220 (6) 220/127 (1) 127 (6)	380/220 (1) 220 (6)	380/220 (1, c)	(i)
Congo, Dem. Rep.	50	220 (6, a)	380/220 (1)	380/220 (1, c)	(i)
Congo, Rep. of	50	220 (6)	380/220 (1)	380/220 (1)	
Costa Rica	60	120 (6, a)	240/120 (5) 120 (6, a)	13.8 kV 240/120 (3, c)	(i)
Croatia	50	380/220 (1) 220 (6)	380/220 (1) 220 (6)	10 kV 6.6 kV 380/220 (1)	(i)
Cyprus	50 ±2.5	240 (6, a)	240 (6, a)	11 kV 415/240 (1)	±6
Czech Republic	50 ±0.1	380/220 (1) 220 (6)	380/220 (1) 220 (6)	22 kV 15 kV 6 kV 3 kV 380/220 (1)	±10
Dahomey	50 ±0.1	380/220 (1) 220 (6)	380/220 (1) 220 (6)	15 kV 380/220 (1)	±10
Denmark	50 ±0.4	380/220 (1) 220 (6)	380/220 (1) 220 (6)	30 kV 10 kV 380/220 (1)	±10
Dominica	50	230 (6, a)	400/230 (1)	400/230 (1, c)	(i)
Dominican Republic	60	110 (6, a)	220/110 (5, a) 110 (6)	220/110 (3, c)	(i)
Ecuador	60	127 (6, a) 120 (6, a) 110 (6)	240/120 (5) 208/120 (1) 220/127 (1) 220/110 (5)	240/120 (5) 208/120 (1) 220/127 (1) 220/110 (5)	±5
Egypt, Arab Republic of	50 ±1	380/220 (1) 220 (6)	380/220 (1) 220 (6)	11 kV 6.6 kV 380/220 (1)	±10
El Salvador (j)	60 ±1	240/120 (5)	240/120 (5, 3)	14.4 kV 2.4 kV 240/210 (3)	±5
Equatorial Guinea	50	220 (6)	220 (6)		
Ethiopia	50	220 (6, a)	380/220 (1)	380/220 (1, c)	(i)
Falkland Islands (UK)	50 ±3	230 (6, a)	415/230 (1)	415/230 (1, c)	±2.5

Integritas* Industrial Battery Charger

Table A-1: Summary of Worldwide Power Information					
Country	Frequency (Hz) and Tolerance (%)	Residential Voltage	Commercial Voltage	Industrial Voltage	Voltage Tolerance (%)
Fiji Islands	50 ±1	415/240 (1)	415/240 (1)	11 kV	(i)
Finland	50 ±0.1	240 (6)	240 (6)	415/240 (1)	±10
		220 (6, 1)	380/220 (1)	660/380 (1)	
France	50 ±1	500 (7)		380/220 (1, 9)	±10
		380/220 (1)	380/220 (1)	20 kV	
		220 (6)	380/220 (9)	15 kV	
		220/127 (2)	380 (7)	380 (7)	
Gabon	50	127 (6)		380/220 (1, 9)	±10
		220 (6)	380/220 (1)	380/220 (1)	
Gambia	50	230 (1, a)	230 (1, a)	400/230 (1, c)	5 (1)
Germany					
West (j)	50 ±0.3	380/220 (1)	380/220 (1)	20 kV	±10
East	50 ±0.3	220 (6)	220 (6)	10 kV	±5
		380/220 (1)	380/220 (1)	10 kV	
		220 (6)	220 (6)	6 kV	
		220/127 (1)		660/380 (1)	
Ghana	50 ±5	127 (6)		380/220 (1)	±10
		250 (6, a)	250 (6, a)	440/250 (1, c)	
Gibraltar	50 ±1	415/240 (1)	415/240 (1)	415/240 (1, c)	±6
Greece	50 ±1	220 (6, a)	6.6 kV	22 kV	±5
			380/220 (1)	20 kV	
				15 kV	
				6.6 kV	
				380/220 (1)	
Greenland (Denmark)	50	380/220 (1)	380/220 (1)	380/220 (1)	(i)
Grenada	50	220 (6)			(i)
		230 (6, a)	400/230 (1)	400/230 (1, c)	
Guadeloupe (France)	50 & 60	220 (6, a)	380/220 (1)	20 kV	(i)
Guam (U.S.) (Mariana Islands)	60 ±1			380/220 (1)	±8 - 10
		240/120 (5)	240/120 (5)	13.8 kV	
		208/120 (1)	208/120 (1)	4.0 kV	
		240 (6)	480/277 (1)	240/120 (4)	
Guatemala	60 ±1.7	120 (6)	480 (10)		±10
			208/120 (1)		
		240/120 (5)	240/120 (5)	13.8 kV	
Guiana (France)	50 & 60			240/120 (3)	±10
		220/110 (5)	220/110 (5)	220 (10)	

Integritas* Industrial Battery Charger

Table A-1: Summary of Worldwide Power Information

Country	Frequency (Hz) and Tolerance (%)	Residential Voltage	Commercial Voltage	Industrial Voltage	Voltage Tolerance (%)
Guinea	50	380/220 (1) 220 (6)	380/220 (1)	380/220 (1)	(i)
Guinea-Bissau	50	380/220 (1) 220 (6)	380/220 (1)	380/220 (1)	(i)
Haiti	60	230 (6, a) 220 (6, a) 115 (6)	380/220 (1) 230/115 (5) 220 (6)	380/220 (1) 230/115 (3)	(i)
Honduras	60	110 (6)	220/110 (5) 110 (6)	220/110 (5, c)	(i)
Hong Kong (and Kowloon)	50 ±2	200 (6, 1) 346/200 (1)	11 kV 346/200 (1) 380/220 (1) 200 (6)	11 kV 346/200 (1) 380/220 (1, c)	±6
Hungary	50 ±2	380/220 (1) 220 (6)	380/220 (1) 220 (6)	20 kV 10 kV 380/220 (1)	±5 -10
Iceland	50 ±0.1	380/220 (1) 220 (6)	380/220 (1) 220 (6)	380/220 (1, c)	(i)
India (d) Bombay	50 ±1	440/250 (1) 230 (6)	440/250 (1) 230 (6)	11 kV 440/250 (1)	±4
New Delhi	50 ±3	400/230 (1) 230 (6)	400/230 (1) 230 (6)	11 kV 400/230 (1)	±6
Ramakrishna- puram (b)	50 ±3 25 d.c.	400/230 (1) 230 (6) 460/230	400/230 (1) 230 (6) 460/230	22 kV & 11 kV (i) (i)	±6
Indonesia	50 ±1-2	220/127 (1)	380/220 (1) 220/127 (1)	22 kV 380/220 (1, c)	±5
Iran	50 ±5	220 (6, a)	380/220 (1)	20 kV 11 kV 400/231 (1) 380/220 (1)	±15
Iraq	50	220 (6, a)	80/220 (1)	11 kV 6.6 kV 3 kV 380/220 (1)	±5
Ireland, Northern (j)	50 ±0.4	230 (6, a) 220 (6, a)	400/230 (1) 380/220 (1)	400/230 (1, c) 380/220 (1)	±6
Ireland, Republic of	50	220 (6, a) 380/220 (1)	380/220 (1)	10 kV	(i)

Integritas* Industrial Battery Charger

Table A-1: Summary of Worldwide Power Information

Country	Frequency (Hz) and Tolerance (%)	Residential Voltage	Commercial Voltage	Industrial Voltage	Voltage Tolerance (%)
Israel	50 ±0.2	400/230 (1) 230 (6)	400/230 (1) 230 (6)	22 kV 12.6 kV 6.3 kV 400/230 (1)	±6
Italy	50 ±0.4	380/220 (1) 220/127 (2) 220 (6)	380/220 (1) 220/127 (2)	20 kV 15 kV 10 kV 380/220 (1) 220 (8)	±5 (urban) ±10 (rural)
Ivory Coast	50	220 (6, a)	380/220 (1)	380/220 (1, c)	(i)
Jamaica	50 ±1	220/110 (3, 5)	220/110 (3, 5)	4/2.3 kV 220/110 (3)	±6
Japan (d)					
East	50 ±0.2	200/100 (5) 100 (6)	200/100 (4, 5)	6.6 kV 200/100 (4) 200 (3, 11)	±10
West	60 ±0.1	210/105 (5) 200/100 (5) 100(6)	210/105 (4, 5) 200/100 (5) 100(6)	22kV 6.6kV 210/105 (4) 200/100 (4)	±10
Jordan	50	380/220 (1) 220 (6)	380/220 (1)	380/220 (1, c)	(i)
Kenya	50	240 (6, a)	415/240 (1)	415/240 (1, c)	(i)
Korea, D.P.R. of (North) (j)	60	220 (6)	380/220 (1)	380/220 (1)	±6.8 -13.6
Korea, Rep. of (South)	60	100 (6)	200/100 (5)	22 kV 6.6 kV	±5
Kuwait	50	240 (6, a)	415/240 (1)	415/240 (1, c)	(i)
Laos	50 ±8	380/220 (1)	380/220 (1)	380/220 (1, c)	±6
Lebanon	50	220 (6, a) 110 (6, a)	380/220 (1) 220 (6) 190/110 (1) 110 (6)	380/220 (1, c) 190/110 (1)	(i)
Lesotho	50	220 (6, a)	380/220 (1)	380/220 (1, c)	(i)
Liberia	60 ±3.3	240/120 (5)	240/120 (5)	12.5/7.2 kV 416/240 (7) 240/120 (5) 208/120 (9)	±1.7

Integritas* Industrial Battery Charger

Table A-1: Summary of Worldwide Power Information

Country	Frequency (Hz) and Tolerance (%)	Residential Voltage	Commercial Voltage	Industrial Voltage	Voltage Tolerance (%)
Libya, S.P.A.J.	50	230 (6, a) 127 (6, a)	400/230 (1) 220/127 (1) 230 (6) 127 (6)	400/230 (1, c) 220/127 (1)	(i)
Luxembourg	50 ±0.5	380/220 (1) 220/127 (1) 208/120 (1)	380/220 (1) 220/127 (1) 208/120 (1)	20 kV 15 kV 5 kV	±5 and ±10
Macao (Portugal)	50	380/220 (1) 230/115 (5)	380/220 (1) 220/127 (1)	380/220 (1) 220/127 (1)	(i) (i)
Malagasy Republic (Madagascar)	50 ±2	220 (6, 1) 127 (6, a)	380/220 (1) 220/127 (1)	5 kV 380/220 (1) 220/127 (1)	±3
Malawi	50	230 (6, a)	400/230 (1)	400/230 (1, c)	(i)
Malaysia	50 ±1.0	240 (6, a)	415/240 (1)	22 kV 415/240 (1, c)	±5
Mali	50	220 (6, a) 127 (6, a)	380/220 (1) 220/127 (1) 220 (6) 127 (6)	380/220 (1, c) 220/127 (1)	(i)
Malta	50 ±1	240 (6, a)	415/240 (1)	11 kV 6.6 kV 3.3 kV 415/240 (1)	(i)
Martinique (France)	50	127 (6, a)	220/127 (1) 127 (6)	220/127 (1, c)	(i)
Mauritania	50	220 (6)	220 (6)	200 (10)	(i)
Mauritius	50 ±1.0	230 (6, 1)	400/230 (1)	400/230 (1, c)	±6
Mexico	60 ±0.2	220/127 (1) 220 (6) 120 (12)	220/127 (1) 220 (6) 120 (12)	13.8 kV 13.2 kV 480/277 (1) 220/127 (7)	±6
Monaco	50	380/220 (1) 220 (6) 220/127 (1) 127 (6)	380/220 (1) 220 (6)	380/220 (1, c)	(i)
Montserrat	60	230 (6, a)	400/230 (1)	400/230 (1, c)	(i)
Morocco	50	220/127 (1) 200/115 (1)	380/220 (1)	380/220 (1, c)	(i)

Integritas* Industrial Battery Charger

Table A-1: Summary of Worldwide Power Information

Country	Frequency (Hz) and Tolerance (%)	Residential Voltage	Commercial Voltage	Industrial Voltage	Voltage Tolerance (%)
Mozambique	50	380/220 (1) 220 (6)	380/220 (1)	380/220 (1)	(i)
Nepal	50 ±1	220 (6, a)	400/220 (1) 220 (6)	11 kV 400/220 (1)	±10
Netherlands	50 ±0.4	380/220 (1) 220 (2, 6)	380/220 (1)	10 kV 3 kV 380/220 (1)	±6
Netherlands Antilles	50 & 60	220 (6, a) 127 (6, a) 120 (6, a) 115 (6, a)	380/220 (1) 230/115 (5) 220/127 (1) 208/120 (1)	380/220 (1, c) 230/115 (3) 220/127 (1) 208/120 (1)	(i)
New Caledonia	50	220 (6)	380/220 (1)	380/220 (1)	
New Zealand	50 ±1.5	400/230 (1, 2) 230 (6) 240 (6)	415/240 (1, 2) 400/230 (1, 2) 230 (6) 240 (6)	11 kV 400/230 (1) 415/240 (1) 440 (f)	±5
Nicaragua	60	240/120 (3, 5)	240/120 (3, 5)	13.2 kV 7.6 kV 240/120 (3)	(i)
Niger	50 ±1	220 (6, a)	15 kV 380/220 (1)	15 kV 380/220 (1)	±2.5
Nigeria	50 ±1	230 (6, a) 220 (6, a)	400/230 (1) 380/220 (1)	15 kV 11 kV 400/230 (1) 380/220 (1)	±5
Norway	50 ±0.2	230 (7)	380/220 (1) 230 (7)	20 kV 10 kV 5 kV 380/220 (1) 230 (7)	±10
Okinawa (Japan)	60	200/100 (5) 100 (6)	200/100 (5) 100 (6)		(i)
Oman Muscat	50	240 (6, a)	415/240 (1) 240 (6)	415/240 (1, c)	(i)
Pakistan	50	230 (6, a)	400/230 (1) 230 (6)	400/230 (1, c)	(i)
Panama	60 ±0.17	240/120 (5)	480/277 (1) 240/120 (5)	12 kV 480/277 (1) 208/120 (1)	±5

Integritas* Industrial Battery Charger

Table A-1: Summary of Worldwide Power Information

Country	Frequency (Hz) and Tolerance (%)	Residential Voltage	Commercial Voltage	Industrial Voltage	Voltage Tolerance (%)
Papua New Guinea	50 ±2	240 (6, 1)	415/240 (1) 240 (6)	22 kV 11 kV 415/240 (1)	±5
Paraguay	50	220 (6, a)	440/220 (5) 380/220 (1)	440/220 (3, c) 380/220 (1)	(i)
Peru	60	225 (7, 12)	225 (7, 12)	10 kV 6 kV 225 (7)	(i)
Philippines (excluding Manila metropolitan area)	60 ±1.6	220/110 (5)	13.8 kV 4.16 kV 2.4 kV 220/110 (4)	13.8 kV 4.16 kV 2.4 kV 440 (10) 220/110 (4)	±5
Manila metropolitan area	60 ±0.05	240/120 (4, 5) 240/120 (4)	240/120 (4, 5) 240/120 (4)	20 kV 6.24 kV 3.6 kV 240/120 (4)	±5
Poland	50 ±1	220 (6, a)	380/220 (1)	15 kV 6 kV 380/220 (1)	±5
Portugal	50 ±1	380/220 (1) 220 (6)	15 kV 5 kV 380/220 (1) 220 (6)	15 kV 5 kV 380/220 (1)	±5
Puerto Rico & Virgin Islands (U.S.)	60 ±10	240/120 (6)	480 (10) 240/120 (6)	8.32 kV 4.16 kV 480 (10)	±10
Qatar	50	240 (6, 1)	415/240 (1) 240 (6)	415/240 (1, c)	±6
Romania	50 ±1	220 (6, a)	380/220 (6)	20 kV 10 kV 6 kV 380/220 (1)	±5
Russia: See Commonwealth of Independent States					
Rwanda	50 ±1	220 (6, a)	380/220 (1)	15 kV 6.6 kV 380/220 (1)	±5

Integritas* Industrial Battery Charger

Table A-1: Summary of Worldwide Power Information

Country	Frequency (Hz) and Tolerance (%)	Residential Voltage	Commercial Voltage	Industrial Voltage	Voltage Tolerance (%)
Sabah (Malaysia)	50 ±0.5	240 (6, a)	415/240 (1)	415/240 (1, c)	±6
St. Kitts & Nevis	60	230 (6, a)	400/230 (1)	400/230 (1, c)	(i)
St. Lucia	50	240 (6, a)	415/240 (1)	11 kV 415/240 (1)	(i)
St. Vincent	50	230 (6, a)	400/230 (1)	3.3 kV 400/230 (1)	(i)
Saudi Arabia	50 ±0.5 60 ±0.5	220/127 (1) 127 (6)	380/220 (1) 220/127 (1) 127 (6)	380/220 (1, c) 220/127 (1) 13.8 kV	±5
Senegal	50	127 (6, a)	220/127 (1) 127 (6)	220/127 (1, c)	(i)
Seychelles Islands	50	240 (6, a)	415/240 (1)	415/240 (1, c)	(i)
Sierra Leone	50	230 (6, a)	400/230 (1) 230 (6)	11 kV 400/230 (1)	(i)
Singapore	50 ±0.5	400/230 (1) 230 (6)	6.6 kV 400/230 (1)	22 kV 6.6 kV 400/230 (1)	±3
Slovakia	50 ±0.1	380/220 (1) 220 (6)	380/220 (1) 220 (6)	22 kV 15 kV 6 kV 3 kV 380/220 (1)	±10
Slovenia	50	380/220 (1) 220 (6)	380/220 (1) 220 (6)	10 kV 6.6 kV 380/220 (1)	(i)
Somalia Republic	50	230 (6) 220 (6) 110 (6, a)	440/220 (5) 220/110 (5) 230 (6)	440/220 (3, c) 220/110 (3)	(i)
South African Republic	50 ±2.5 25 (h)	433/250 (1, g) 400/230 (1, g) 380/220 (1) 220 (6)	11 kV 6.6 kV 3.3 kV 433/250 (1, g) 400/230 (1, g) 380/220 (1)	11 kV 6.6 kV 3.3 kV 500 (7) 380/220 (1)	±6
Spain	50 ±3	380/220 (1, 2) 220 (6) 220/127 (1, 2) 127 (6)	380/220 (1) 220/127 (1)	5 kV 11 kV 380/220 (1)	±7

Integritas* Industrial Battery Charger

Table A-1: Summary of Worldwide Power Information

Country	Frequency (Hz) and Tolerance (%)	Residential Voltage	Commercial Voltage	Industrial Voltage	Voltage Tolerance (%)
Sri Lanka (Ceylon)	50 ±2	230 (6, 1)	400/230 (1) 230 (6)	11 kV 400/230 (1)	±6
Sudan	50	240 (6, a)	415/240 (1) 240 (6)	415/240 (1, c)	(i)
Suriname	50 & 60	115 (6) 127 (6, a)	230/115 (5) 220/127 (1) 220/110 (5)	230/115 (3, c) 220/127 (1) 220/110 (3)	(i)
Swaziland	50 ±2.5	230 (6, a)	400/230 (1) 230 (6)	11 kV 400/230 (1)	±6
Sweden	50 ±0.2	380/220 (1) 220 (6)	380/220 (1) 220 (6)	20 kV 10 kV 6 kV 380/220 (1)	±10
Switzerland	50 ±0.5	380/220 (1) 220 (6)	380/220 (1) 220 (6)	16 kV 11 kV 6 kV 380/220 (1)	±10
Syrian Arab. Republic.	50	220 (6, a) 115 (6, a)	380/220 (1) 220 (6) 220/115 (1) 115 (6)	380/220 (1, c) 200/115 (1)	(i)
Taiwan (j) (Formosa)	60 ±4	380/220 (1) 220 (6) 220/110 (5) 110 (6)	380/220 (1) 220/110 (4)	22.8 kV 11.4 kV 380/220 (1) 220 (4)	±5 ±10
Tanzania (j)	50	400/230 (1)	400/230 (1)	11 kV 400/230 (1)	(i)
Thailand	50 ±1	220 (6, 1)	433/250 (1) 380/220 (1) 220 (6)	22 kV 380/220 (1, c)	±5
Togo	50	220 (6, a)	380/220 (1)	20 kV 5.5 kV 380/220 (1)	(i)
Tonga	50	415/240 (1) 240 (6) 110 (6)	415/240 (1) 240 (6) 110 (6)	11 kV 6.6 kV 415/240 (1)	(i)
Trinidad & Tobago	60 ±0.5	230/115 (5)	400/230 (1) 230/115 (3)	12 kV 400/230 (1)	±6

Integritas* Industrial Battery Charger

Table A-1: Summary of Worldwide Power Information					
Country	Frequency (Hz) and Tolerance (%)	Residential Voltage	Commercial Voltage	Industrial Voltage	Voltage Tolerance (%)
Tunisia (j)	50 ±2	380/220 (1) 220 (6)	380/220 (1) 220 (6)	15 kV 10 kV 380/220 (1)	±10
Turkey (j)	50 ±2	220 (6, a)	380/220 (1)	15 kV 6.3 kV 380/220 (1)	±10
Uganda	50 ±0.1	240 (6, a)	415/240 (1)	11 kV 415/240 (1)	±4.5
United Arab Emirates					
Abu Dhabi	50	415/240 (1)	415/240 (1)	415/240 (1, c)	(i)
Ajman	50	230 (6, a)	400/230 (1)	11 kV	(i)
Dubai	50 ±0.5	220 (6, a)	380/220 (1) 220 (6)	6.6 kV 380/220 (1)	±2 to 3
United Kingdom (excluding Northern Ireland)	50 ±1	240 (6, a)	415/240 (1)	22 kV 11 kV 6.6 kV 3.3 kV 415/240 (1)	±6
Upper Volta	50	220 (6)	380/220 (1)	380/220 (1)	
Uruguay	50 ±1	220 (7, 6)	220 (7, 6)	15 kV 6 kV 220 (7)	± 6
USA (d)					
Charlotte (North Carolina)	60 ±0.06	240/120 (5) 208/120 (1)	460/265 (1) 240/120 (5) 208/120 (1)	14.4 kV 7.2 kV 2.4 kV 575 (10) 460 (10) 240 (10) 480/277 (1) 240/120 (5) 208/120 (1)	±5 -2.5
Los Angeles (California)	60 ±0.2	240/120 (5) 208/120 (1)	480 (10) 240/120 (4) 208/120 (1)	13.2 kV 4.8 kV 4.16 kV 480 (10) 240/120 (4) 208/120 (1)	±4 -6.6

Integritas* Industrial Battery Charger

Table A-1: Summary of Worldwide Power Information

Country	Frequency (Hz) and Tolerance (%)	Residential Voltage	Commercial Voltage	Industrial Voltage	Voltage Tolerance (%)
Detroit (Michigan)	60 ±0.2	240/120 (5)	4.8 kV	4.8 kV	±5
Miami (Florida)	60 ±0.3	240/120 (5)	240/120 (3) 240/120 (5) 240/120 (4) 208/120 (1)	240/120 (3) 13.2 kV 2.4 kV 480/277 (1) 240/120 (4)	±5
New York (New York)	60	240/120 (5) 208/120 (1)	240/120 (5) 208/120 (1) 240 (10)	12.47 kV 4.16 kV 480/277 (1) 480 (10)	(i)
Pittsburgh (Pennsylvania)	60 ±0.03	240/120 (5)	460/265 (1) 240/120 (1) 208/120 (1) 460 (10) 230 (10)	13.2 kV 11.5 kV 2.4 kV 460/265 (1) 208/120 (1) 460 (10) 230 (10)	±5 (lighting) ±10 (power)
Portland (Oregon)	60	240/120 (5)	480/277 (1) 240/120 (5) 208/120 (1) 480 (10) 240 (10)	19.9 kV 12 kV 7.2 kV 2.4 kV 480/277 (1) 208/120 (1) 480 (10) 240 (10)	(i)
San Francisco (California)	60 ±0.08	240/120 (5)	480/277 (1) 240/120 (5)	20.8 kV 12 kV 4.16 kV 480/277 (1) 240/120 (3)	±5
Toledo (Ohio)	60 ±0.08	240/120 (5) 208/120 (1)	480/277 (8) 240/120 (4) 208/120 (5)	12.47kV 7.2kV 4.8kV 4.16kV 480 (10) 480/277 (1) 208/120 (1)	±5

Integritas* Industrial Battery Charger

Table A-1: Summary of Worldwide Power Information

Country	Frequency (Hz) and Tolerance (%)	Residential Voltage	Commercial Voltage	Industrial Voltage	Voltage Tolerance (%)
USSR: See Commonwealth of Independent States					
Venezuela	60	240/120 (3) 208/120 (1)	240/120 (3) 208/120 (1)	13.8 kV 12.47 kV 4.8 kV 4.16 kV 2.4 kV 240/120 (3) 208/120 (1)	(i)
Vietnam	50 ±0.1	220 (6, a) 120 (6, a)	380/220 (1) 208/120 (1)	15 kV 380/220 (1)	±10
Western Samoa	50	400/230	(i)	(i)	(i)
Yemen Arab Republic	50	220	(i)	(i)	(i)
Yemen (PDR)	50 ±1	250 (6, a)	440/250 (1)	440/250 (1, c)	±4
Yugoslavia	50	380/220 (1) 220 (6)	380/220 (1) 220 (6)	10 kV 6.6 kV 380/220 (1)	(i)
Zambia	50 ±2.5	230 (6, a)	400/230 (1)	400/230 (1, c)	±3.75
Zimbabwe	50 ±2.5	225 (6, a)	390/225 (1)	11 kV 390/225 (1)	±6.6

ABB
 Integrated DC Power
 601 Shiloh Road
 Plano, TX 75074
 +1 877 546 3243
<http://www.geindustrial.com/products/critical-power>

*Registered trademark of the ABB Inc.

The ABB brand, logo, and illumination are trademarks of the ABB Inc an ABB Global Corporation.
 Information provided is subject to change without notice. All values are design or typical values when measured under laboratory conditions.

DET1006, Rev. 2 – June 2019