

Top View

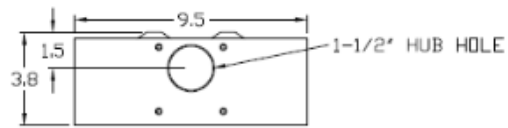

Knockouts

G= 1/2", 3/4", 1" K□
 H= 9/32" K□
 B= 1", 1-1/4", 1-1/2" K□
 D= 3/4", 1", 1-1/4" K□

Left Side View

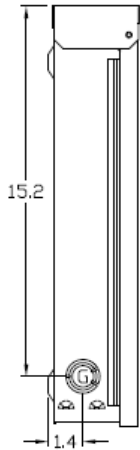

Front View Interior

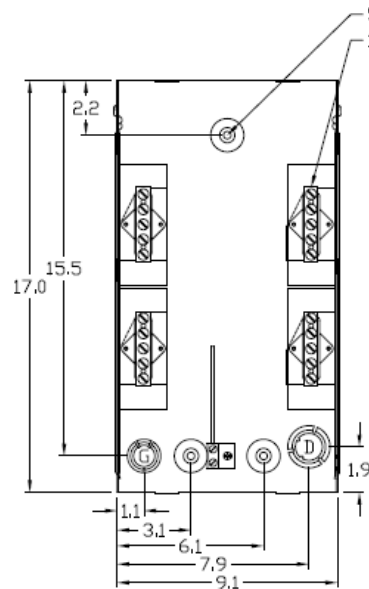

Front View External Covers

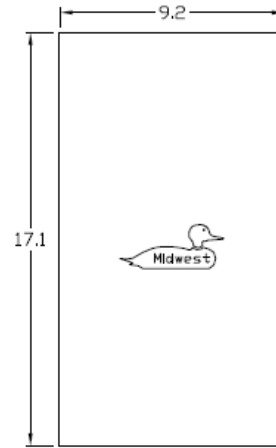

Right Side View

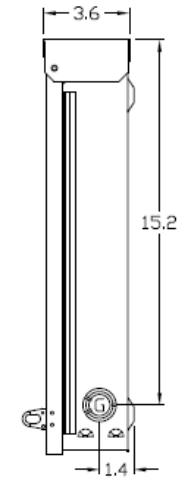

Configuration

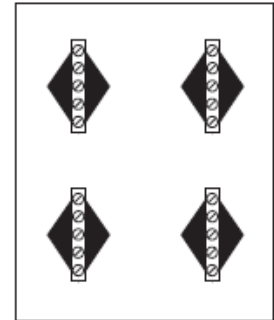

Bottom View

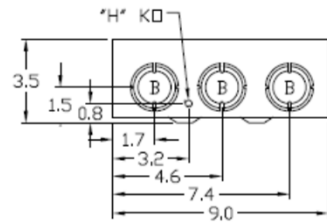

Wire Range Size

CONNECTOR	COPPER		ALUMINUM	
	SOLID	STRAND	SOLID	STRAND
LINE-8102 NEUTRAL	14-8	14-1/0	10-8	10-1/0
LOAD-8102 NEUTRAL	14-8	14-1/0	10-8	10-1/0
NEUTRAL-8102 NEUTRAL	14-8	14-1/0	10-8	10-1/0
EQUIP. GRD.-GL3	12-8	12-2	12-8	12-2



MIDWEST TERMINAL BOX 100A 3PH UL LISTED 600V
 MAX N1/N3R G90 STEEL ENCLOSURE

CAT NO	DWG DATE	REV #
T3610	03/29/2017	01