

Front View

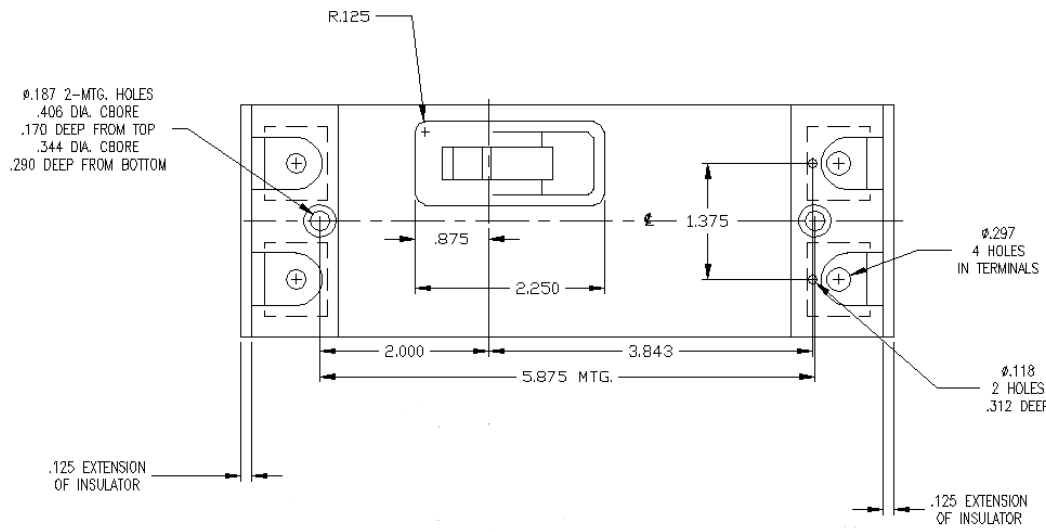

Top View

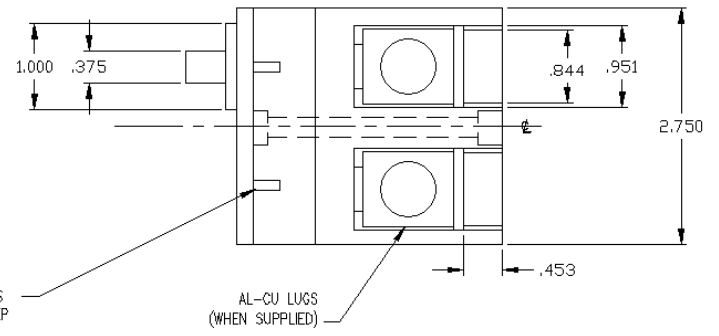

Side View

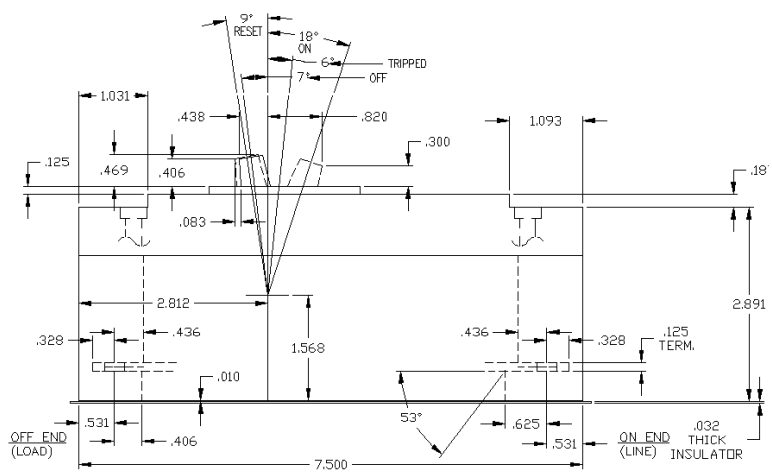

Breaker Amps	Load Side Wire Range Size
100A	(1) #4 – 4/0 (AL or CU)
125A	(1) #4 – 4/0 (AL or CU)
150A	(1) #4 – 4/0 (AL or CU)
175A	(1) 2/0 – 300MCM (AL or CU)
200A	(1) 2/0 – 300MCM (AL or CU)
225A	(1) 2/0 – 300MCM (AL or CU)



imagination at work

175A 2PH TMQD BREAKER 100K @ 208Y/120

REF NO	CAT NO	DWG DATE	REV #
96-1893	TMQD22175	03/20/2015	01